

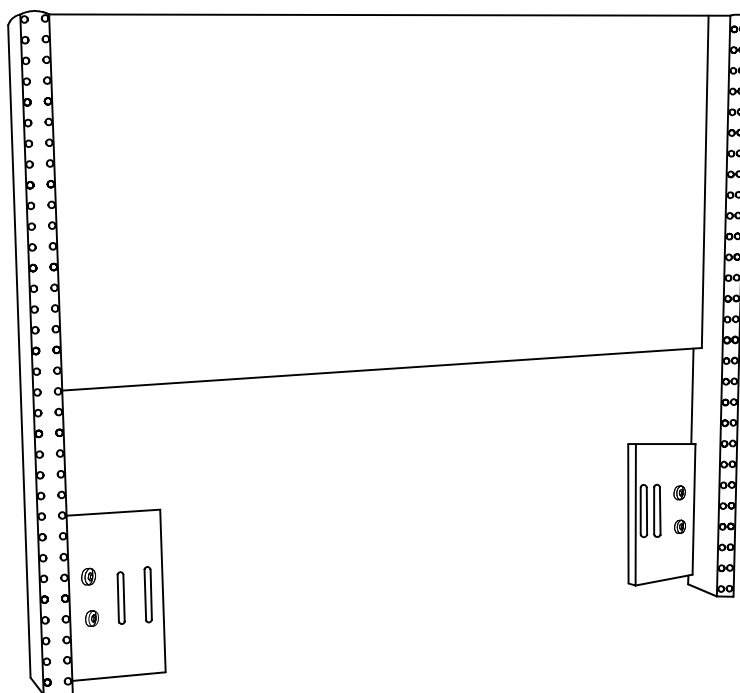









# Upholstered Headboard

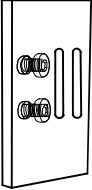
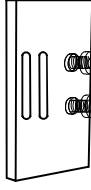

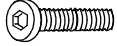
# PARTLIST

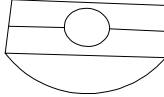
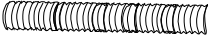
<p><b>A</b></p> 	<p><b>B</b></p> 	<p><b>C</b></p> 	<p><b>D</b></p> 	<p><b>E</b></p> 
<p>Headboard Panel 1 PC</p>	<p>Left Post 1 PC</p>	<p>Right Post 1 PC</p>	<p>Left Headboard Post Support 1 PC</p>	<p>Right Headboard Post Support 1 PC</p>

# HARDWARE LIST

<p><b>#1</b></p>  <p>5/16"x1-3/4"L</p>	<p><b>#2</b></p> 	<p><b>#3</b></p>  <p>20mm</p>	<p><b>#4</b></p> 	<p><b>#5</b></p>  <p>5/16"x3-1/4"L</p>
<p>Bolt 13PCS(Extra1)</p>	<p>Spring Washer 21PCS(Extra1)</p>	<p>Flat Washer 17PCS(Extra1)</p>	<p>Wing Nut 5PCS(Extra1)</p>	<p>Headless Bolt 5PCS(Extra1)</p>
<p><b>#6</b></p> 	<p><b>#7</b></p>  <p>16mm</p>	<p><b>#8</b></p>  <p>M5</p>	<p><b>#9</b></p> 	
<p>Hex Nut 9PCS(Extra1)</p>	<p>Small Flat Washer 5PCS(Extra1)</p>	<p>Allen Wrench 1PC</p>	<p>Wrench 1PC</p>	

Step 1. Lay headboard panel (part A) down on a soft surface, such as carpet, as shown below. Attach left post (part B) and right post (part C) to headboard panel (part A) using bolts (part #1), spring washers (part #2), flat washers (part #3) and allen wrench (part #8).

NOTE: Please do not fully tighten bolts until unit is fully assembled.

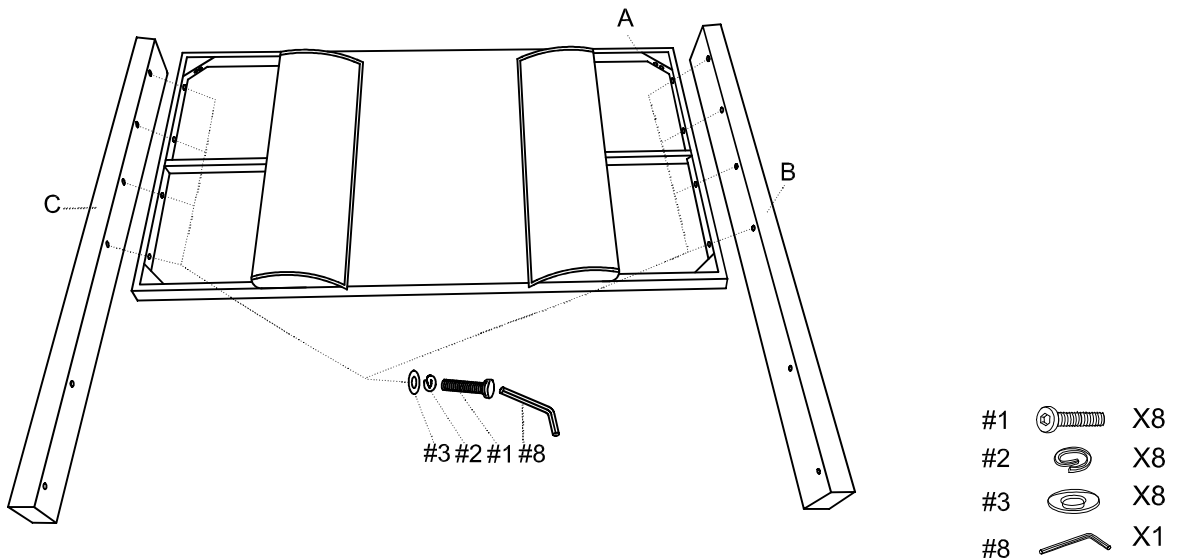

Step 2. Attach left headboard post support (part D) and right headboard post support (part E) to left post (part B) and right post (part C) using headless bolts (part #5), wing nuts (part #4), small flat washers (part #7), spring washers (part #2), hex nuts (part #6) and wrench (part #9).

NOTE: Please do not fully tighten bolts until unit is fully assembled.

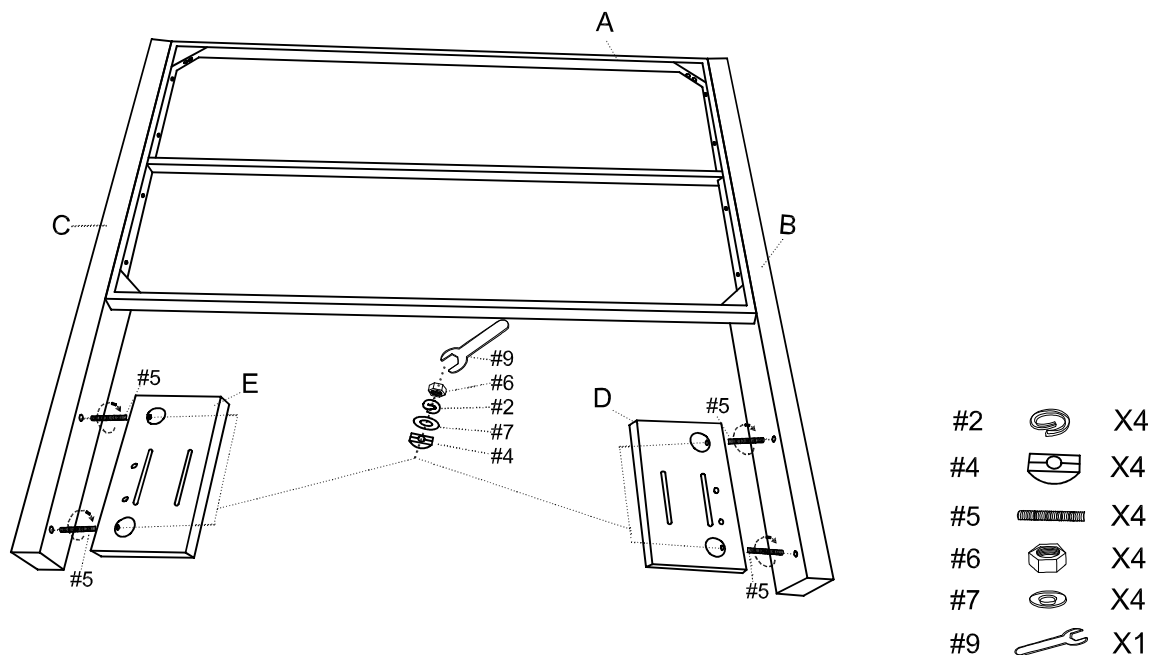

Step 3. Screw out the bolts on the headboard post supports using allen wrench (part #8). Attach bed frame (\*Not Included) to left headboard post support (part D) and right headboard post support (part E) using bolts (part #1), spring washers (part #2), flat washers (part #3), nuts (part #6), allen wrench (part #8) and wrench (part #9).

