

ASSEMBLY INSTRUCTIONS

ItemNumber: N652P434086
N652P434087

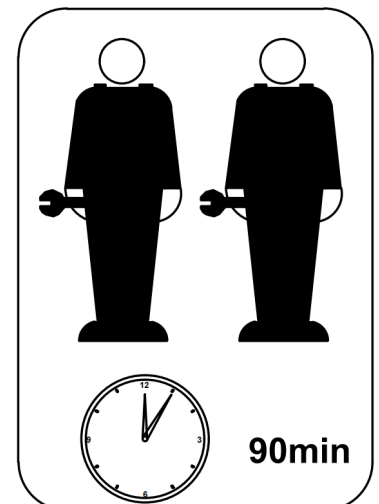
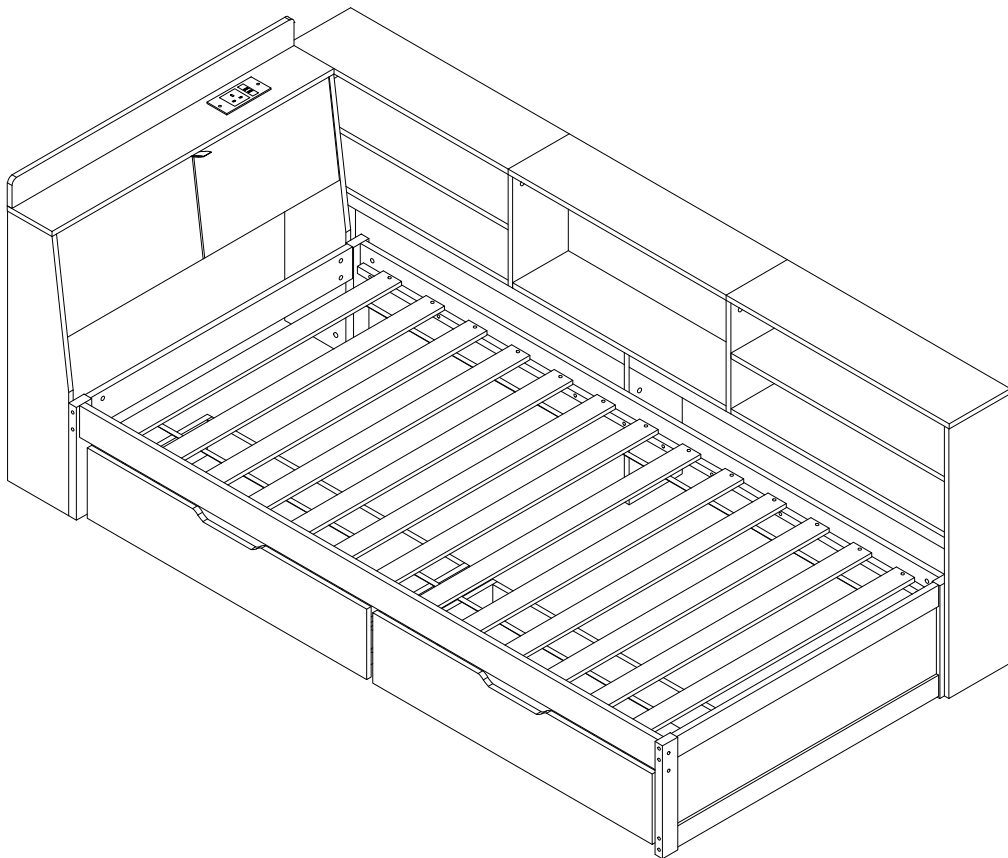

This set comes in 2 boxes. If you do not receive a full 2 boxes, please contact our customer service.

INSTRUCTIONS

IMPORTANT-READ CAREFULLY-RETAIN FOR FUTURE REFERENCE

- a) **WARNING** -Children can become trapped between the bed and the wall, the adjoining pieces of furniture (e.g. cupboards) and the like. To avoid risk of serious injury the distance between the safety barrier and the adjoining structure shall not exceed 75 mm or shall be more than 200 mm.
- b) **WARNING**-Do not use the bed if any structural part is broken or missing; Replacement parts are between requested from the manufacturer or the store.
- c) **WARNING**-Do not climb or wiggle on any non-designated structures.
- d) it is imperative to always follow the installation instructions and manufacturer's use.
- e) The recommended size of the mattress to be used with the bed is 190cmx90cm.
- f) It is necessary to ventilate the room in order to maintain a low level moisture and prevent mold growth in the bed and its periphery.
- g) Joining devices should always be tightened properly and regularly verified. Tighten if necessary.

English

IMPORTANT ! KEEP FOR FUTURE REFERENCE : READ CAREFULLY

- To be assembled by an adult. Assembly must be checked by an adult before use
- **WARNING !** Keep all screws, small parts and plastic bags out of the reach of children
- Properly identify all parts before assembling
- Never use your item if any of its parts are broken or missing
- Should any problems arise, please contact our After Sales Service
- Manufacturer's instructions shall be followed at all times
- Care: Clean with a soft, dry cloth. In case of larger stains, carefully rub with a slightly damp, non-abrasive sponge
- Avoid the risk of fire by not placing furniture near sources of ignition or hot items
- Do not jump on the bed

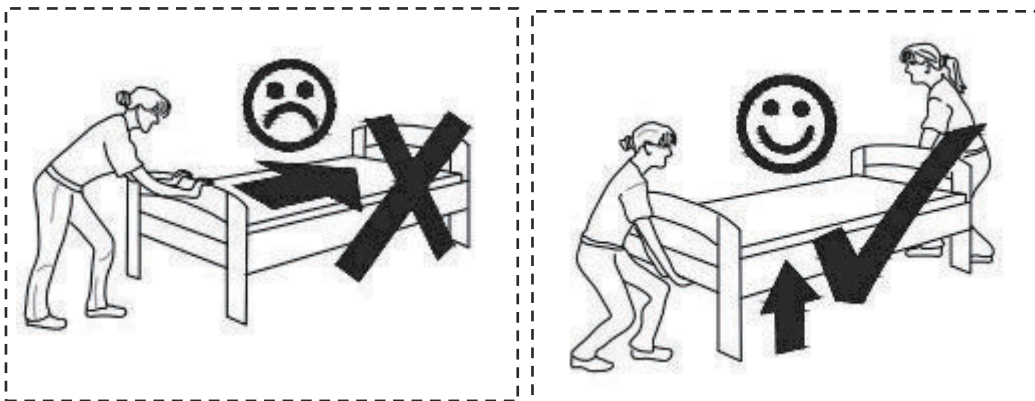



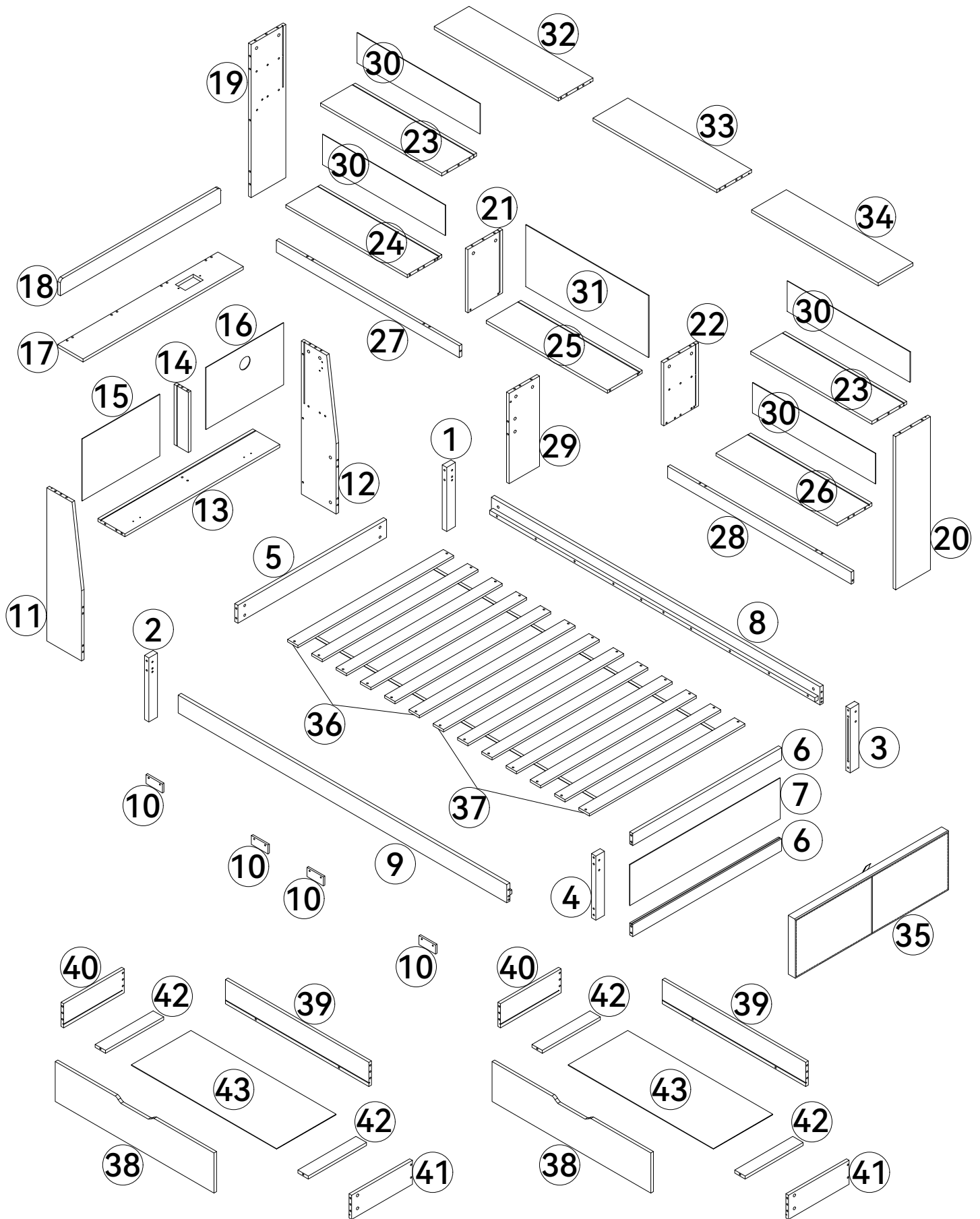





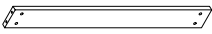



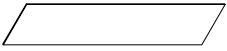

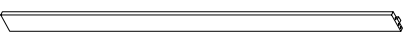

ASSEMBLY INSTRUCTIONS



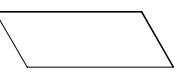
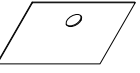
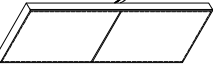
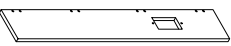
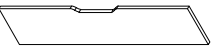



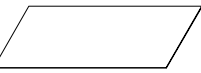

















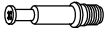

ASSEMBLY INSTRUCTIONS

N652P434086

5		1PC	24		1PC
6		2PCS	25		1PC
7		1PC	26		1PC
8		1PC	27		1PC
9		1PC	28		1PC
14		1PC	30		4PCS
15		1PC	31		1PC
16		1PC	35		1PC
17		1PC	38		2PCS
18		1PC	42		4PCS
23		2PCS	43		2PCS



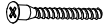
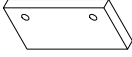







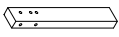

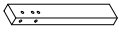
ASSEMBLY INSTRUCTIONS

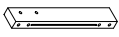
N652P434086

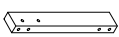
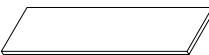
A	6x100		12PCS	N	3.5x16		16PCS
B	6x70		8PCS	O			8PCS
C			20PCS	P	4x20		8PCS
D	∅8x30		43PCS	Q	4x25		26PCS
E		E1  (3.5x18) E2 	6PCS	R			2PCS
F			2PCS	S	M4		1PC
G			2PCS	T			1PC
H			66PCS	U		U1  U2 	2PCS
I			66PCS	V			28PCS
J	3x14		4PCS	W			2PCS
K	3x16		4PCS	X	∅8x50		4PCS
L	5x40		25PCS	10			4PCS
M	3.5x14		54PCS				

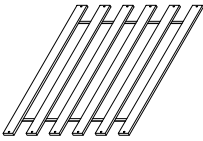
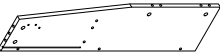
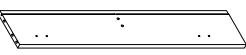
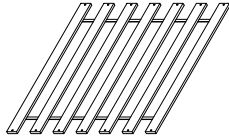
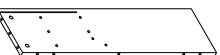
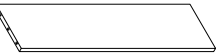
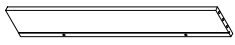
ASSEMBLY INSTRUCTIONS

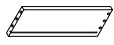

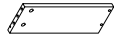

N652P434087

1		1PC	29		1PC
2		1PC	32		1PC
3		1PC	33		1PC
4		1PC	34		1PC
11		1PC	36		1PC
12		1PC			
13		1PC	37		1PC
19		1PC			
20		1PC	39		2PCS
21		1PC	40		2PCS
22		1PC	41		2PCS

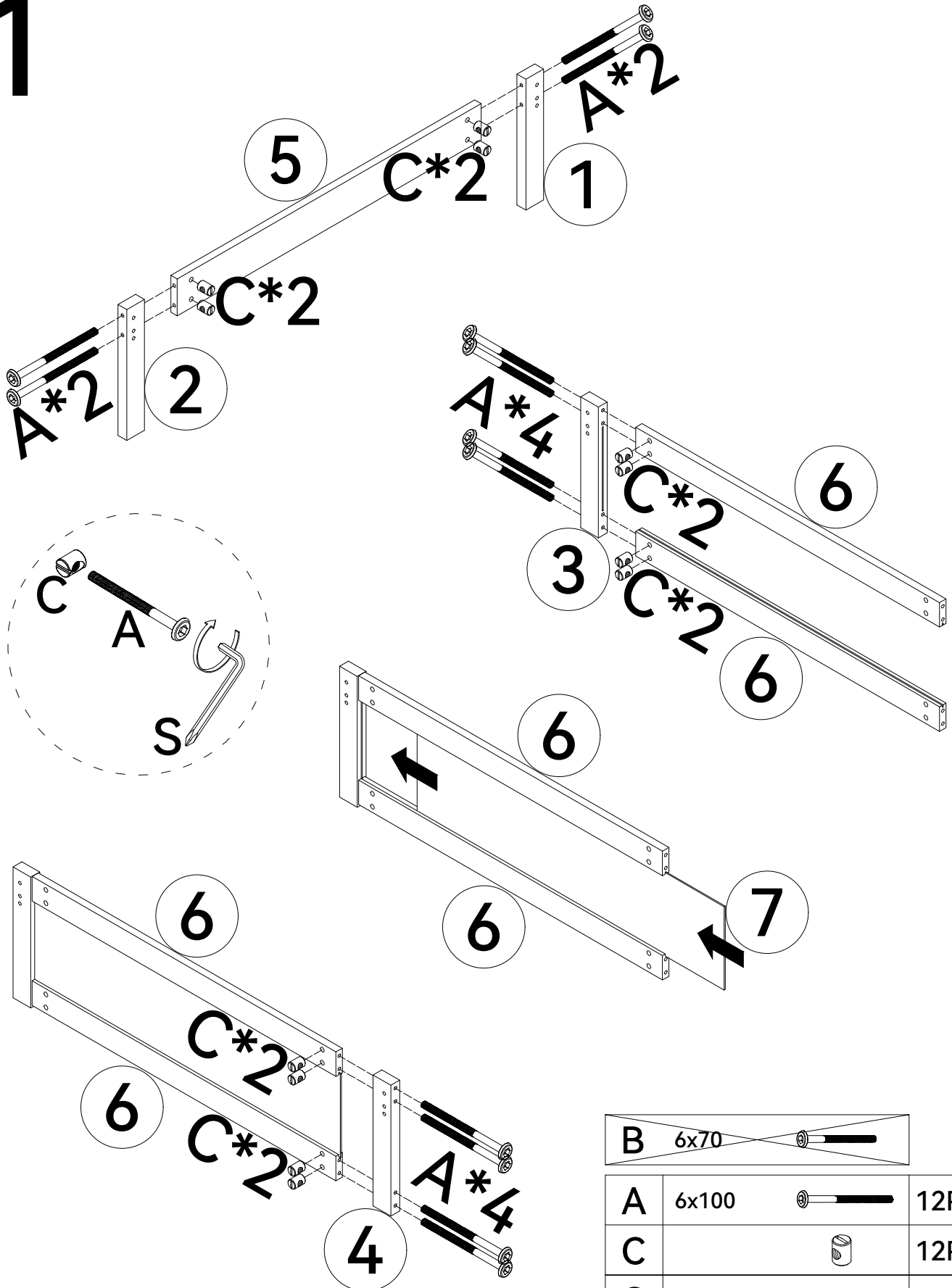
ASSEMBLY INSTRUCTIONS

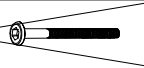
1



B	6x70		
A	6x100		12PCS
C			12PCS
S	M4		1PC

ASSEMBLY INSTRUCTIONS

2

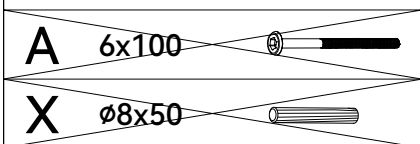
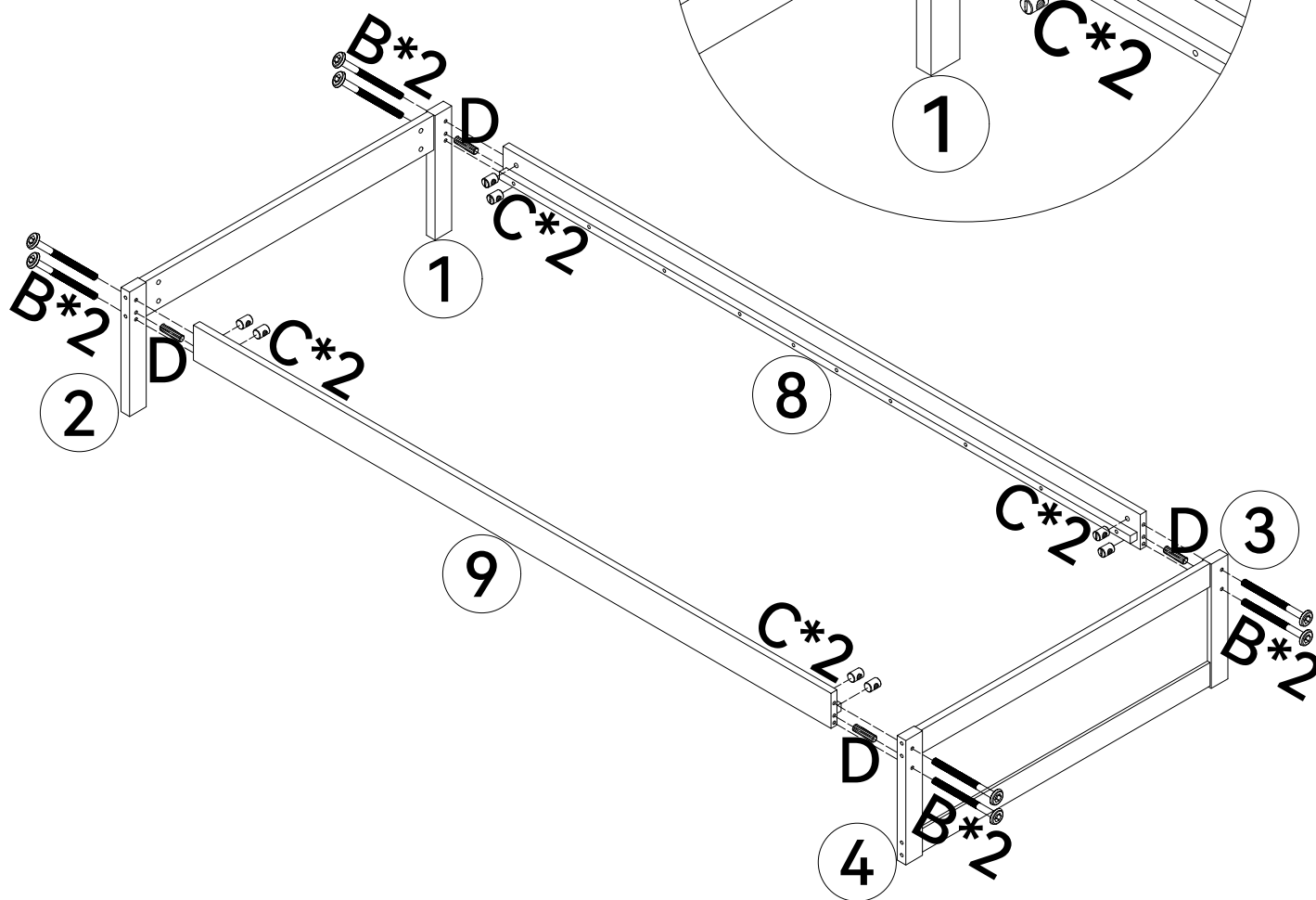
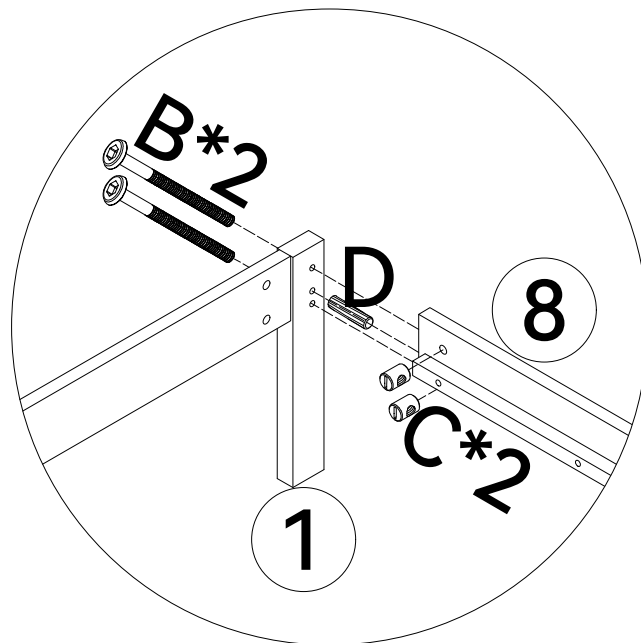

B	6x70		8PCS
C			8PCS
D	ø8x30		4PCS
S	M4		1PC

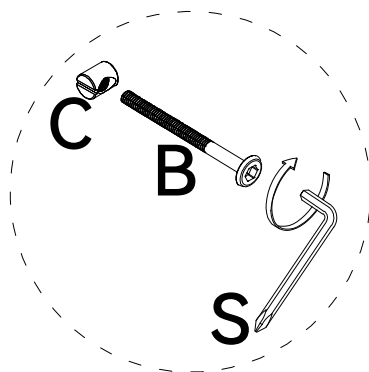

ASSEMBLY INSTRUCTIONS

3

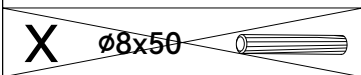
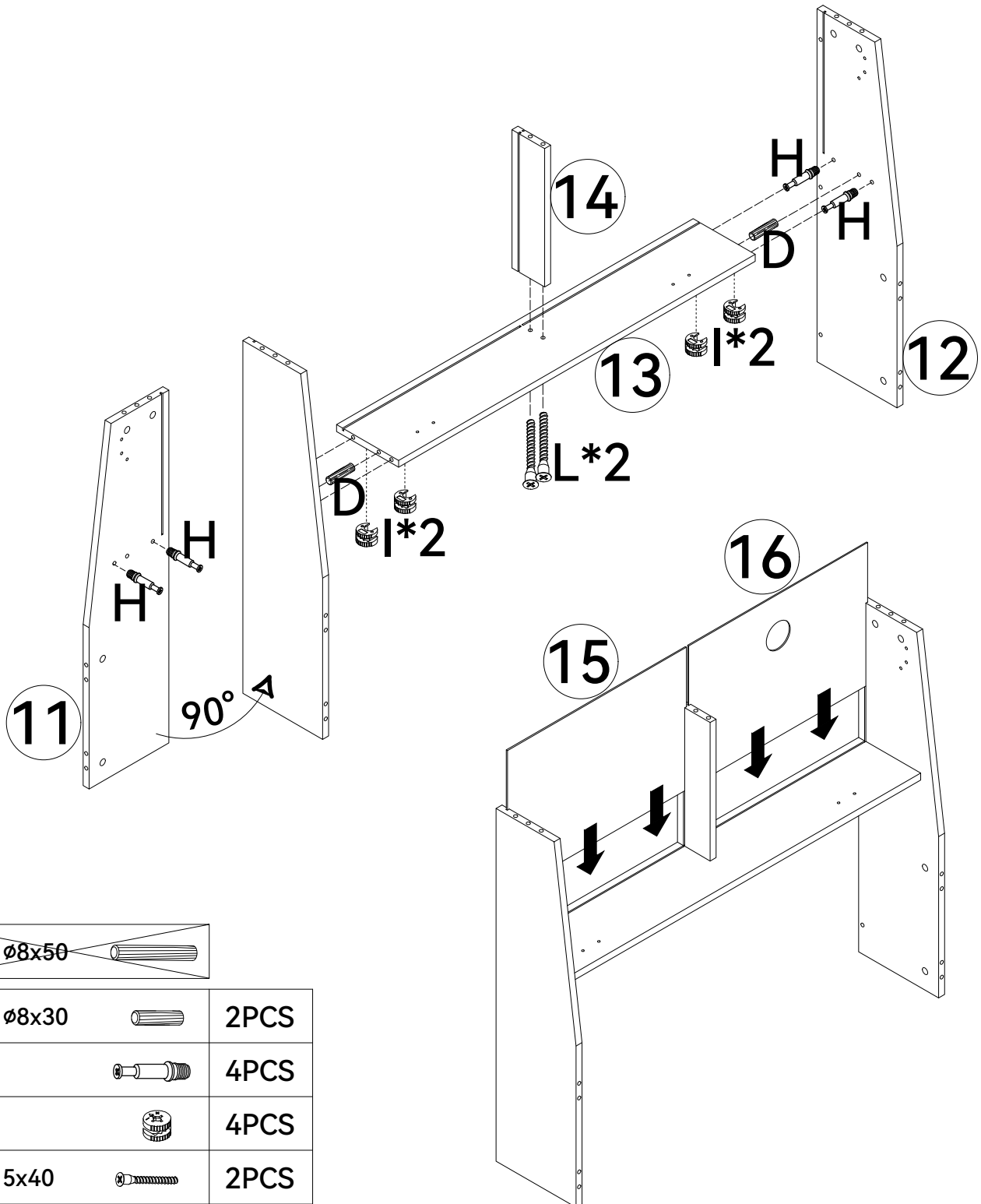
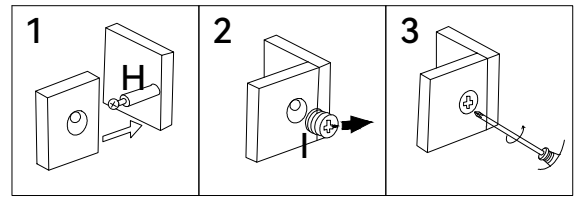

D	ø8x30		2PCS
H			4PCS
I			4PCS
L	5x40		2PCS
S	M4		1PC

ASSEMBLY INSTRUCTIONS

4

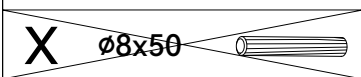
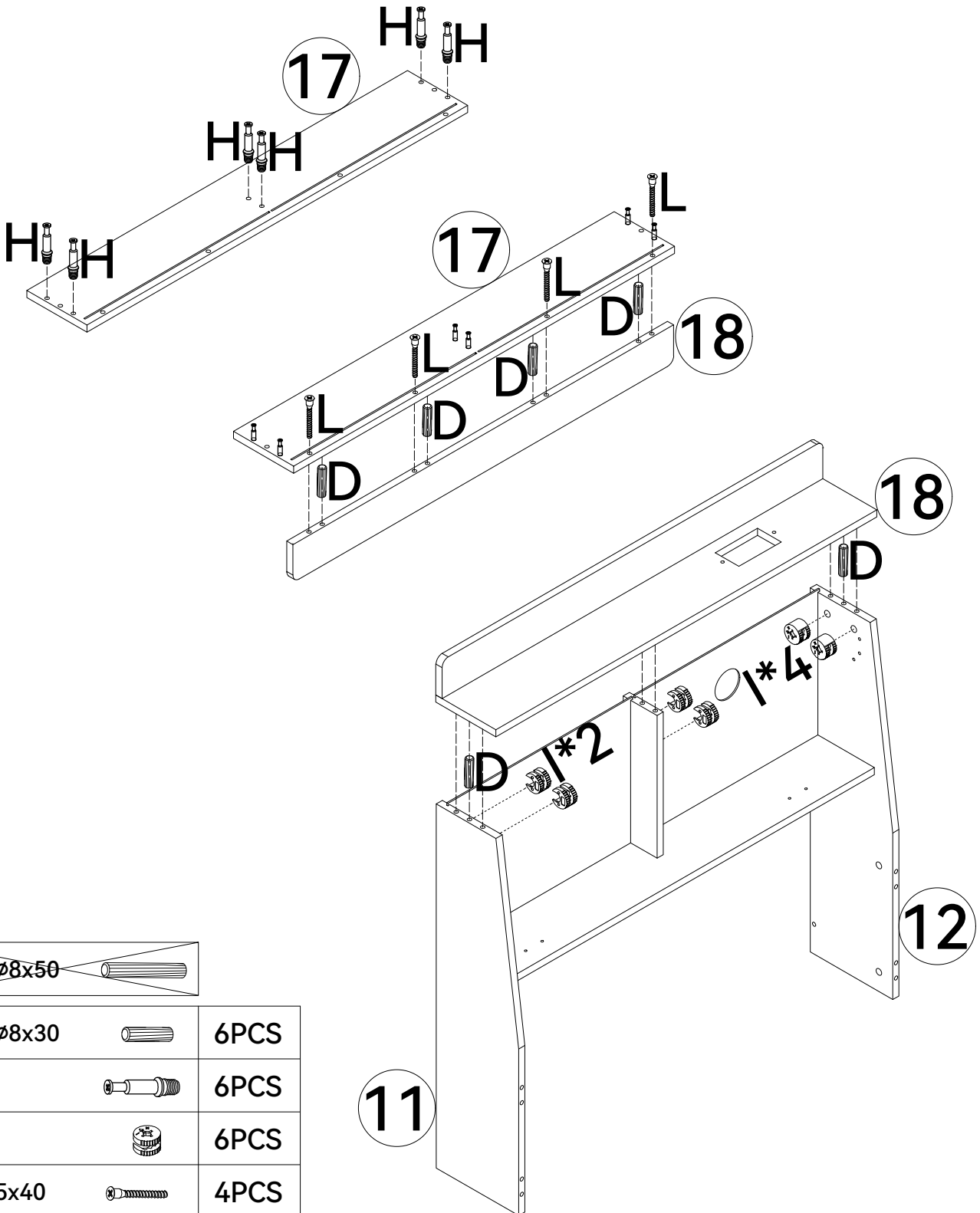
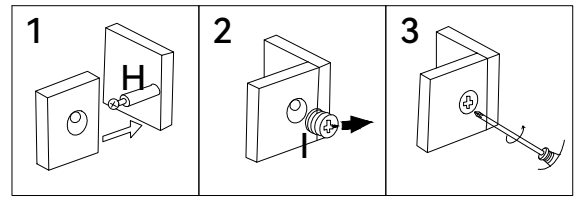

X	ø8x50		6PCS
D	ø8x30		6PCS
H			6PCS
I			6PCS
L	5x40		4PCS
S	M4		1PC

ASSEMBLY INSTRUCTIONS

5

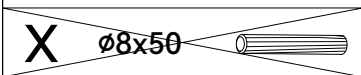
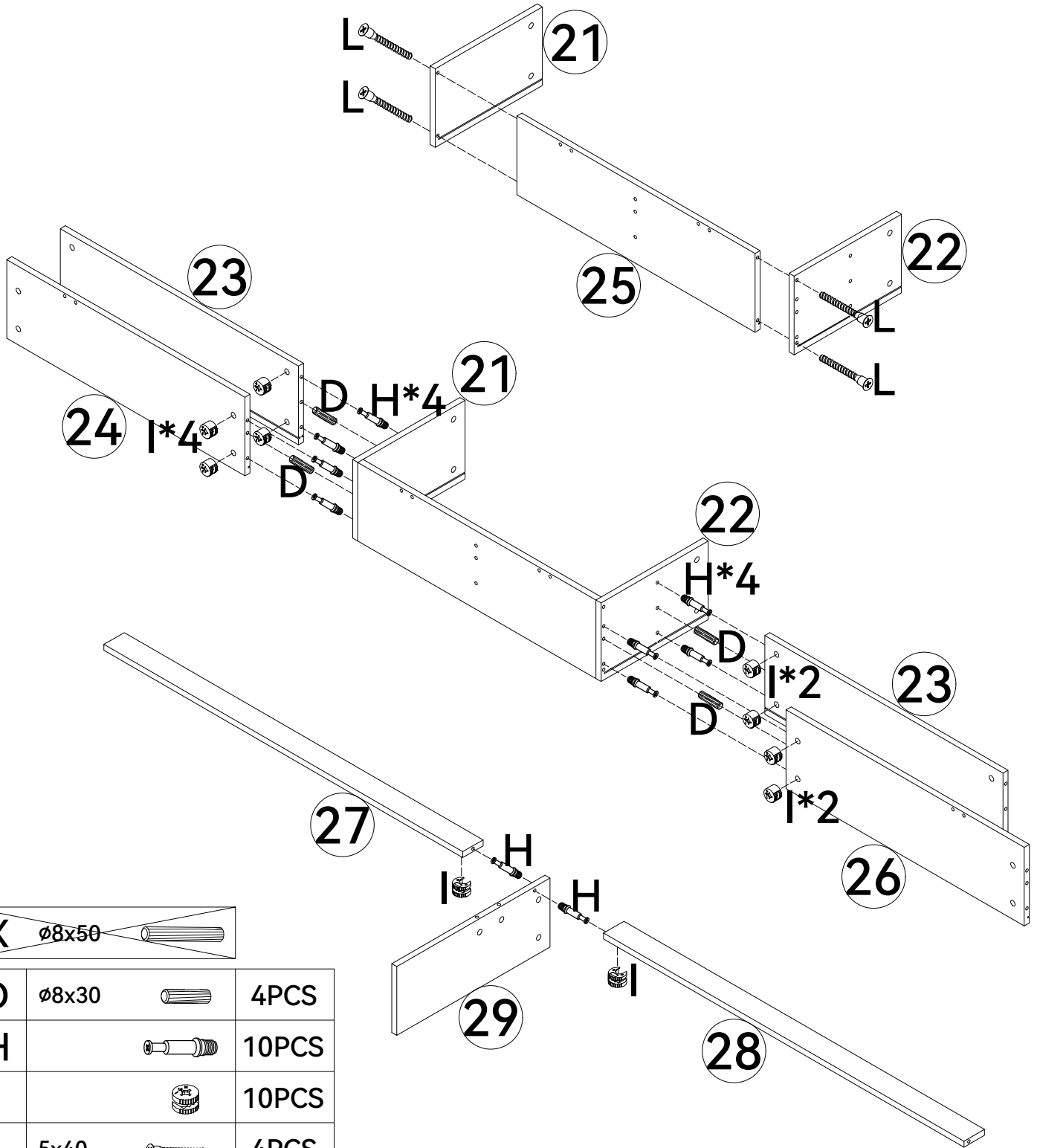
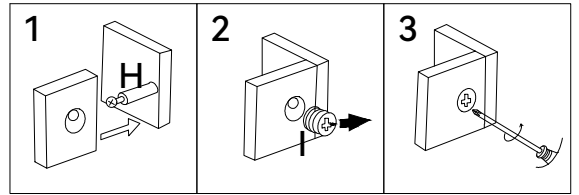

D	$\varnothing 8 \times 30$		4PCS
H			10PCS
I			10PCS
L	5x40		4PCS
S	M4		1PC

ASSEMBLY INSTRUCTIONS

6

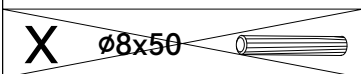
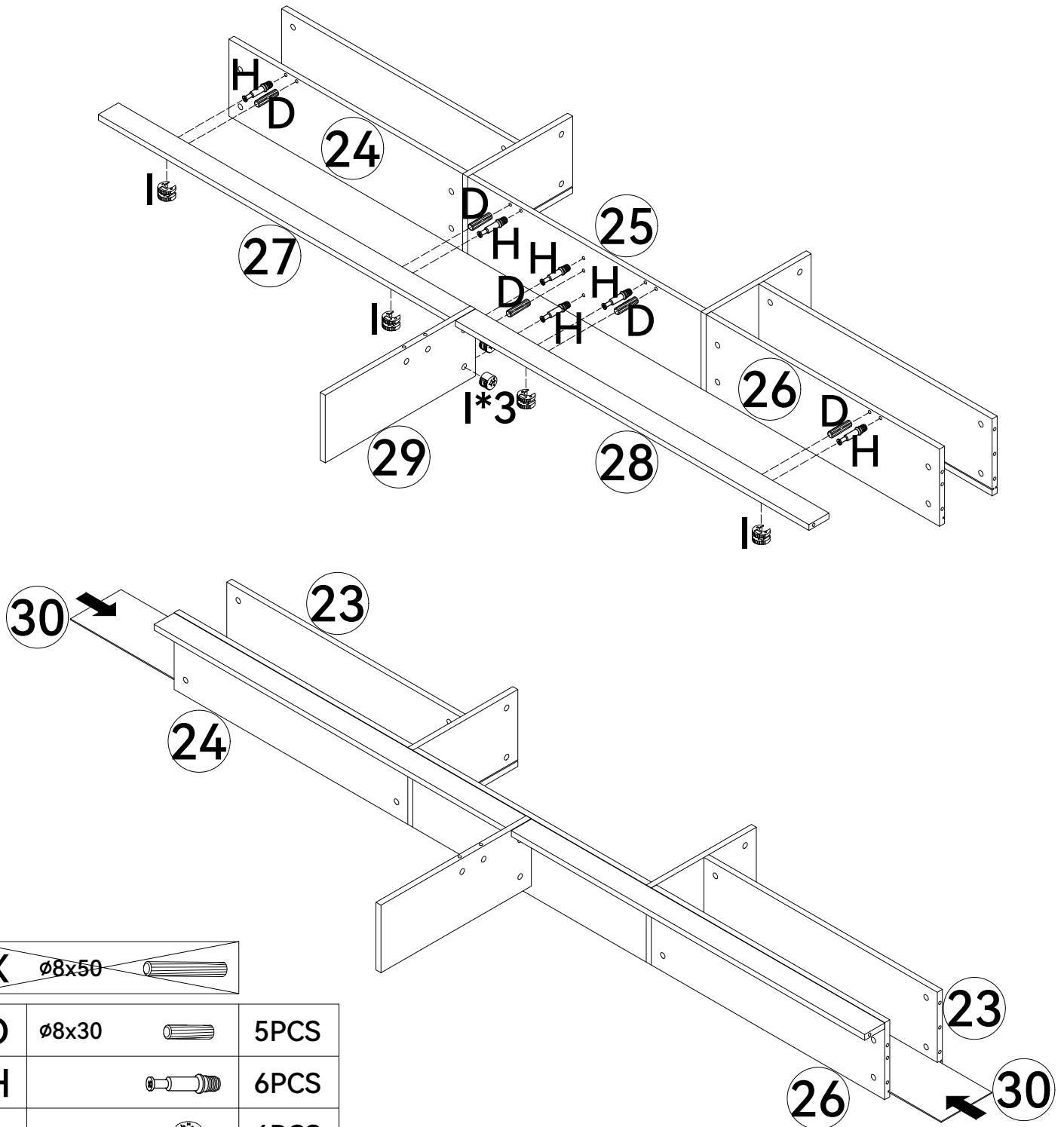
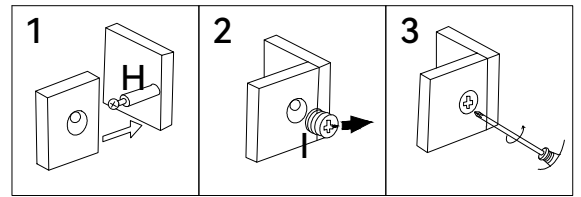

D	ø8x30		5PCS
H			6PCS
I			6PCS
S	M4		1PC

ASSEMBLY INSTRUCTIONS

7

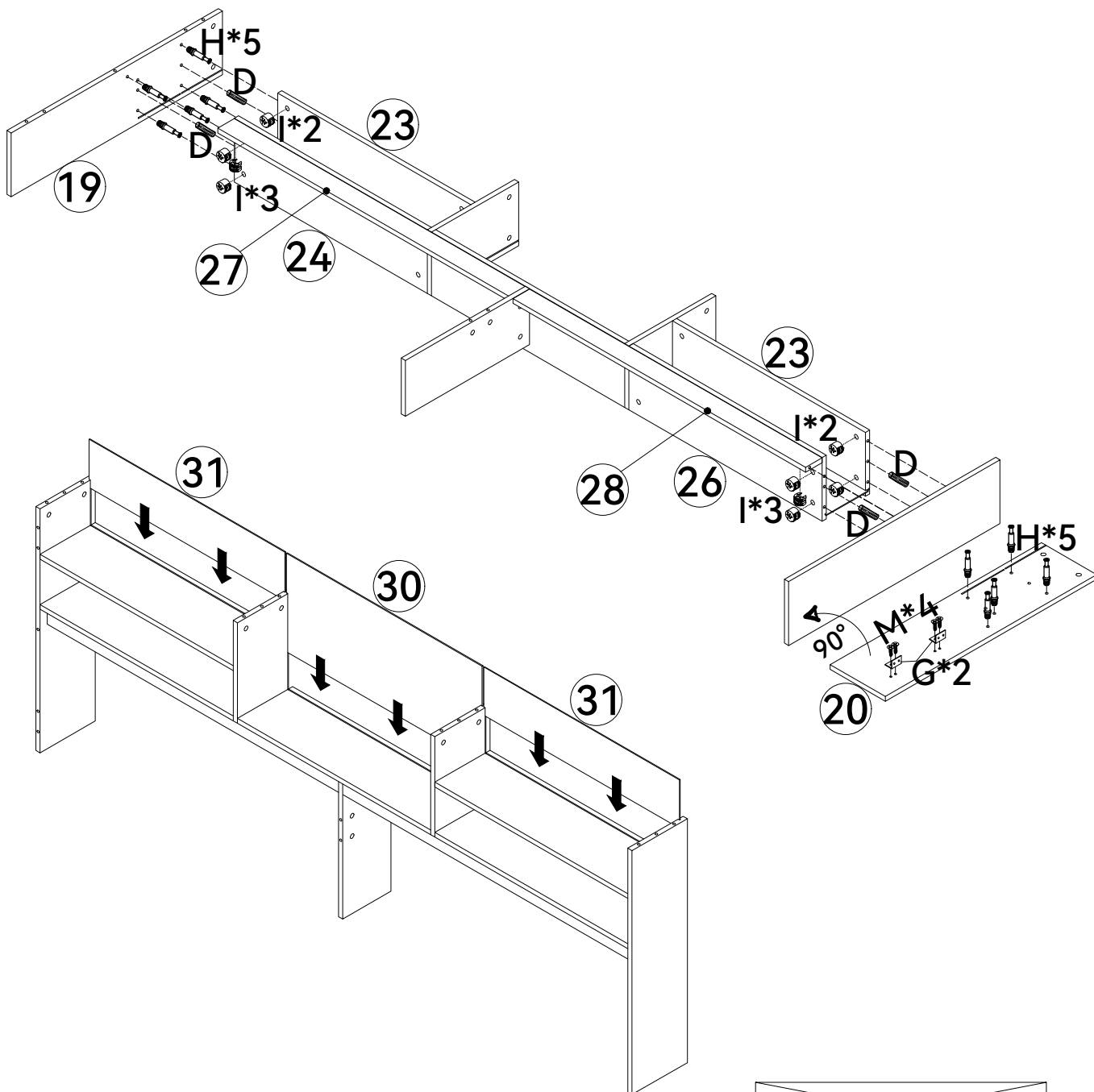
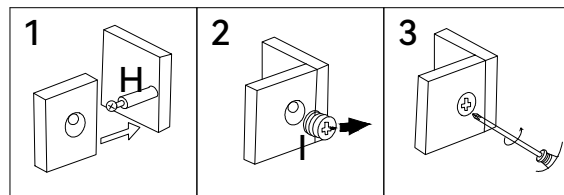

D	∅8x30		4PCS	G		2PCS
H			10PCS	M	3.5x14	4PCS
I			10PCS	S	M4	1PC

J	3x14	
K	3x16	
N	3.5x16	
X	∅8x50	

ASSEMBLY INSTRUCTIONS

8

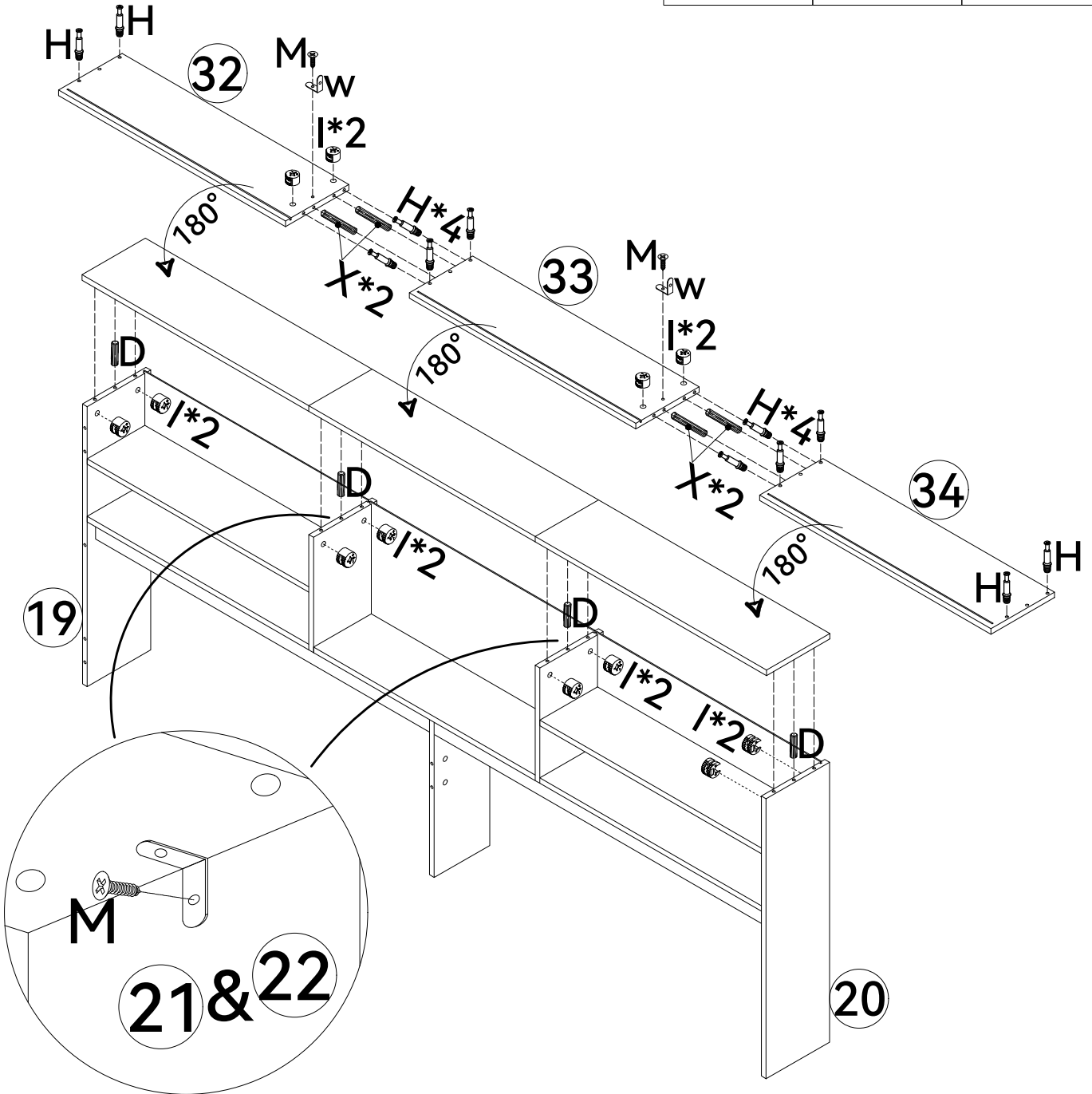
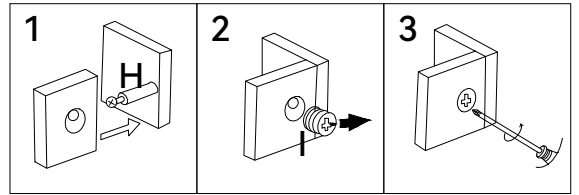





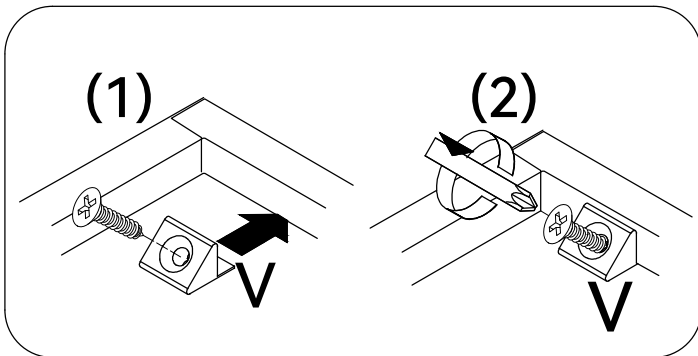
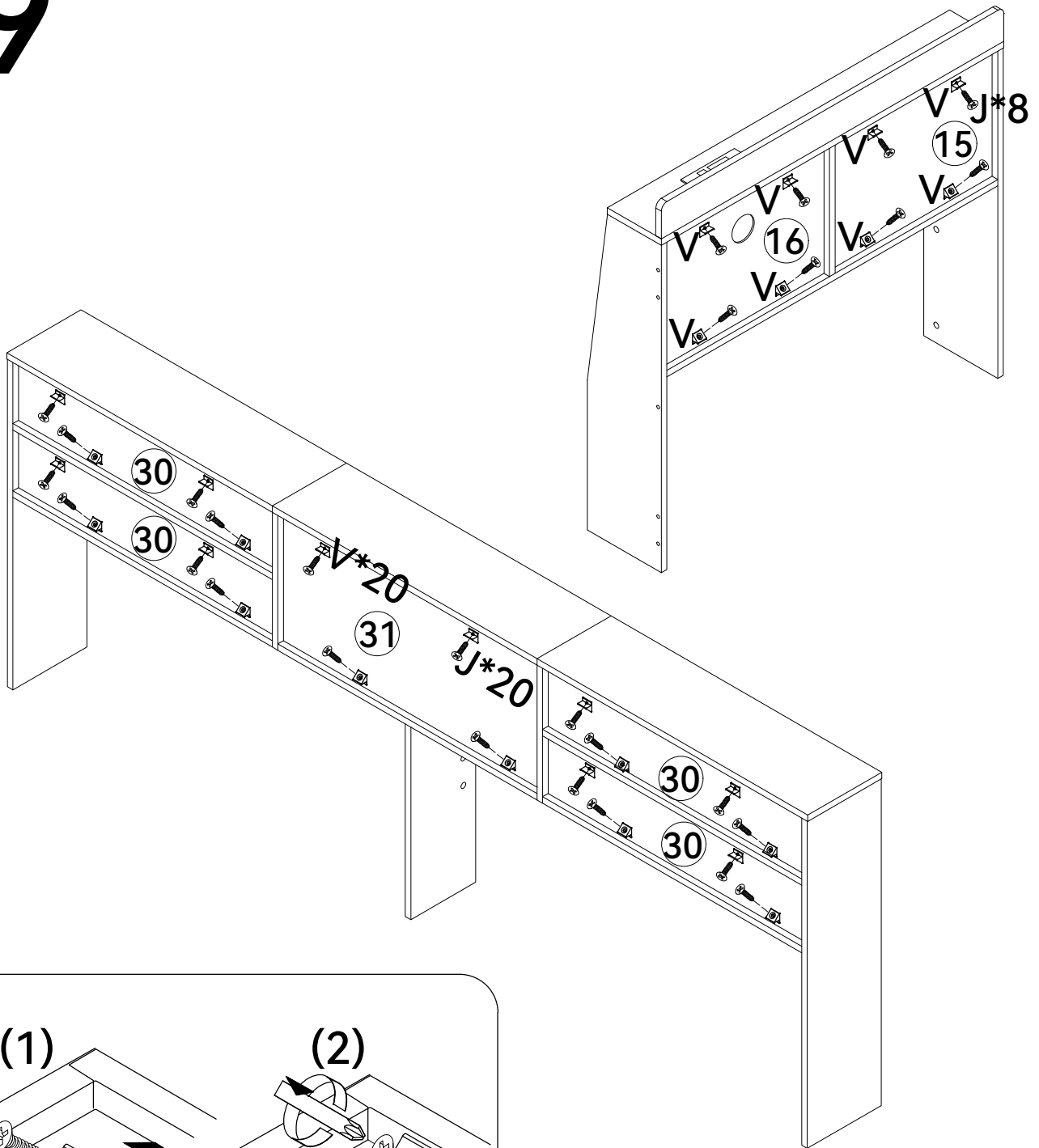

D	∅8x30		4PCS						
H			12PCS	W		2PCS	J	3x14	
I			12PCS	X	∅8x50	4PCS	K	3x16	
M	3.5x14		4PCS	S	M4	1PC	N	3.5x16	

ASSEMBLY INSTRUCTIONS

9





M	3.5x14		28PCS	J	3x14	
V			28PCS	K	3x16	
S	M4		1PC	N	3.5x16	

ASSEMBLY INSTRUCTIONS

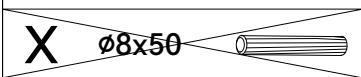
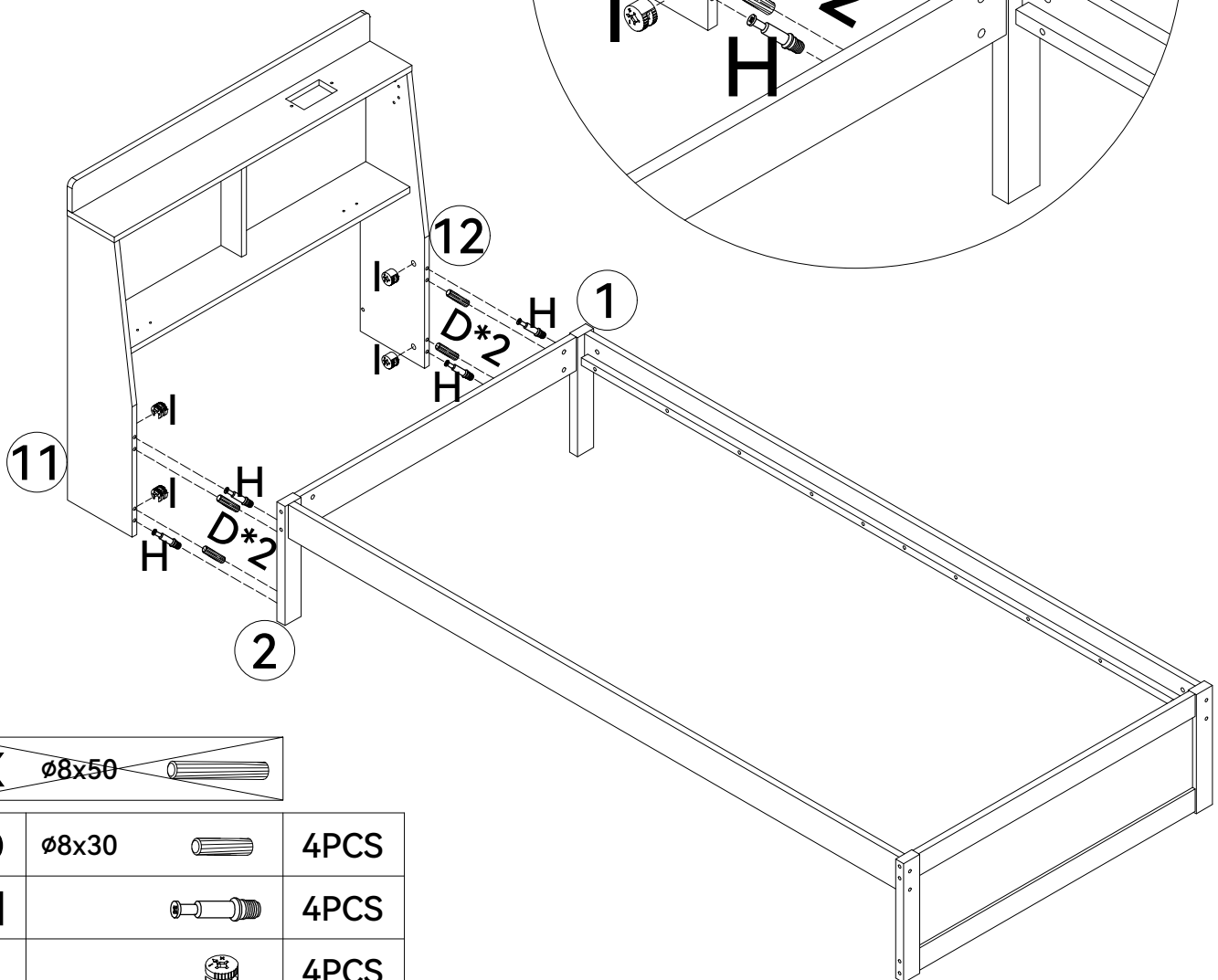
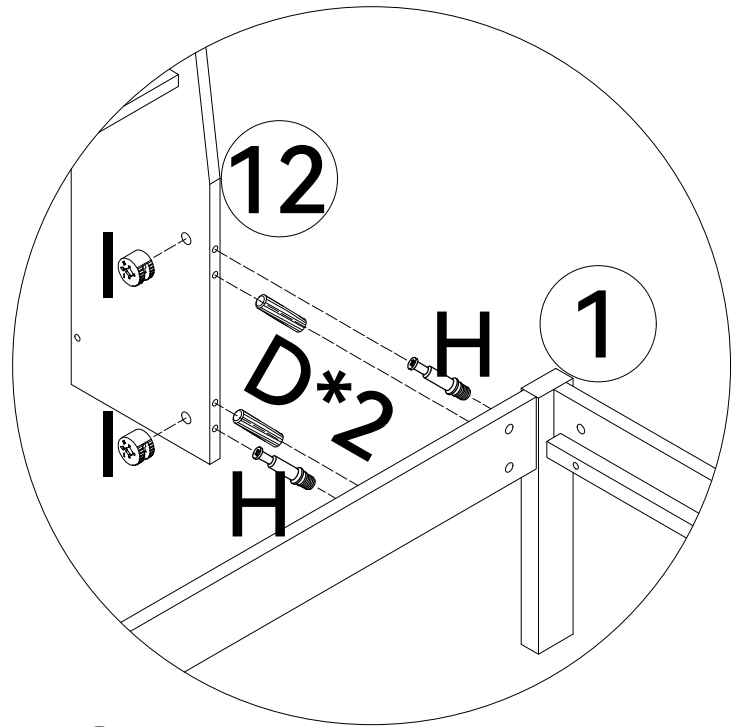
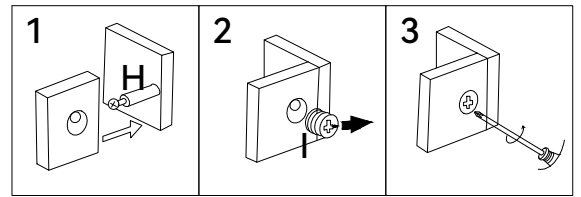
10

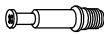

D	ø8x30		4PCS
H			4PCS
I			4PCS
S	M4		1PC

ASSEMBLY INSTRUCTIONS

11

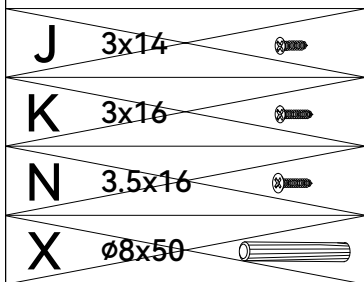
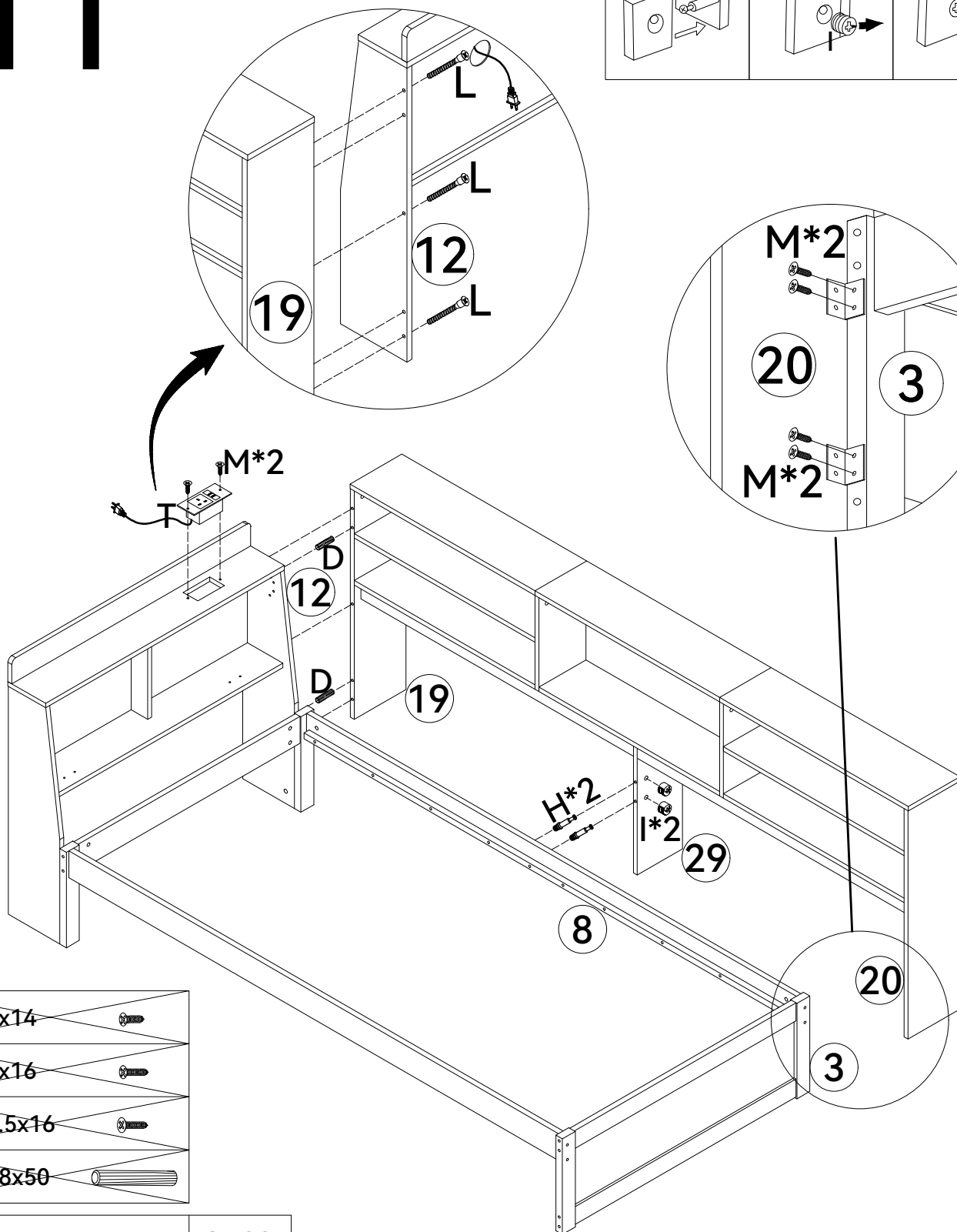
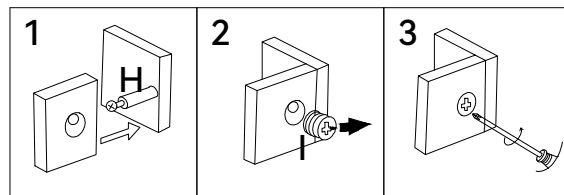

D	ø8x30		2PCS								
H			2PCS	L	5x40		3PCS	T		1PC	
I			2PCS	M	3.5x14		6PCS	S	M4		1PC

ASSEMBLY INSTRUCTIONS

12

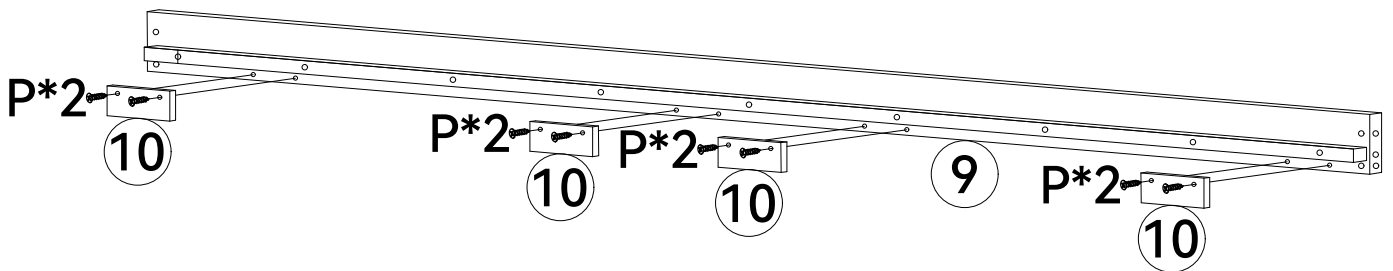
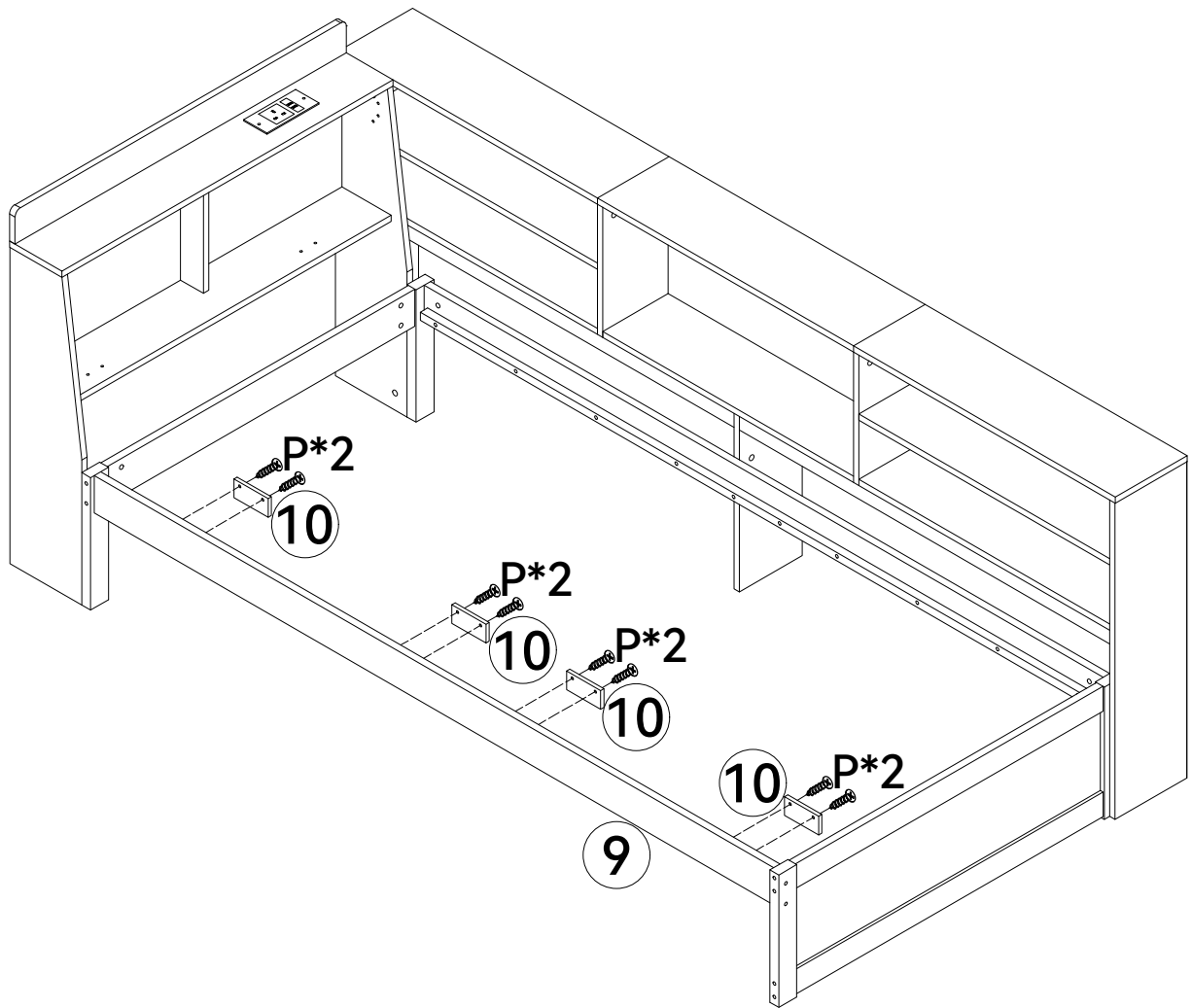





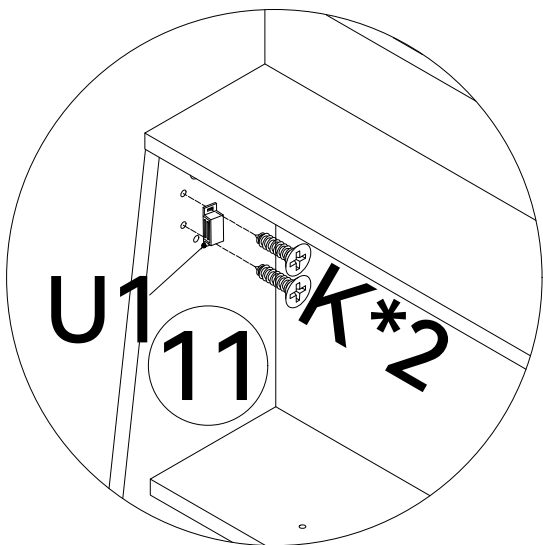
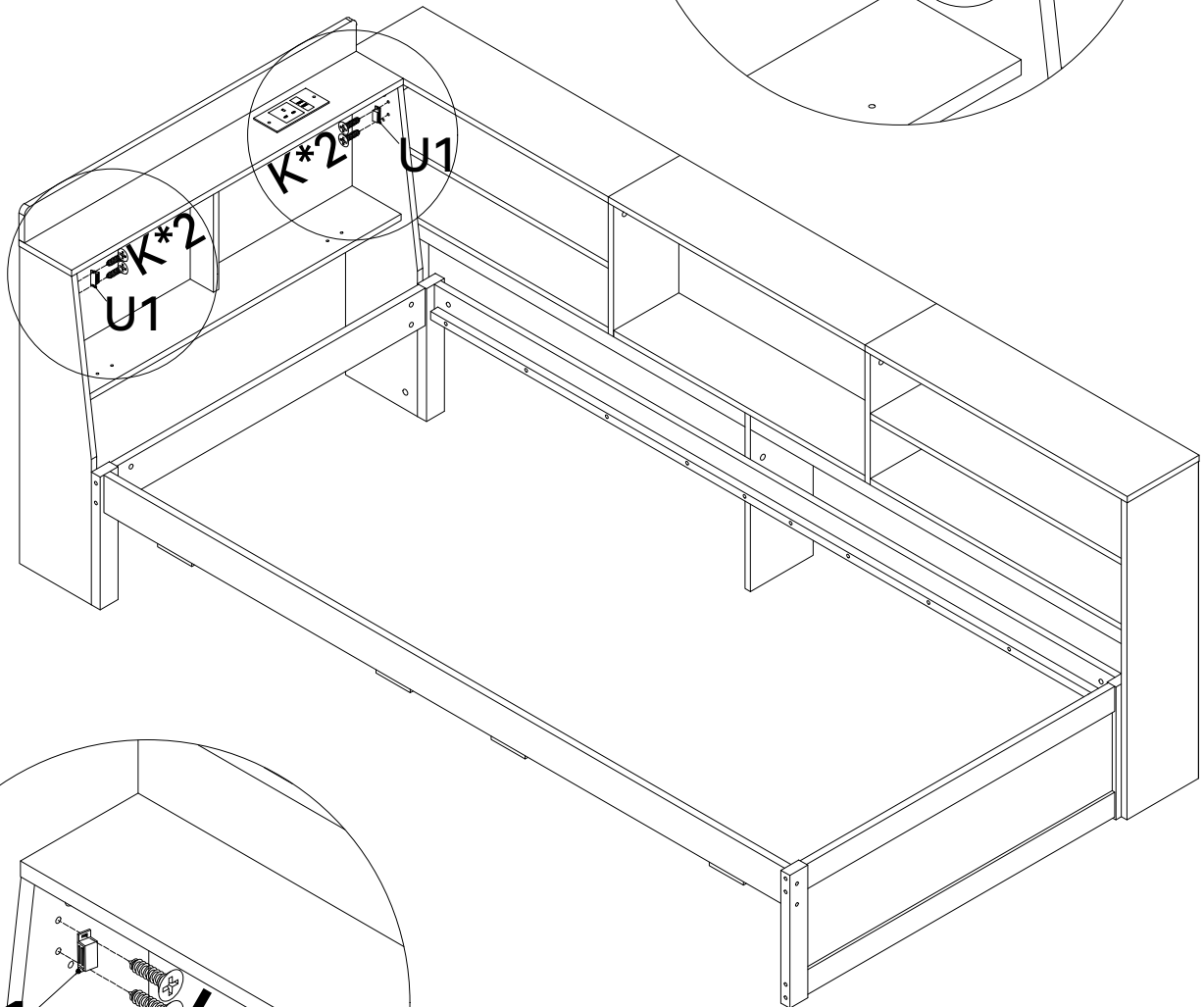
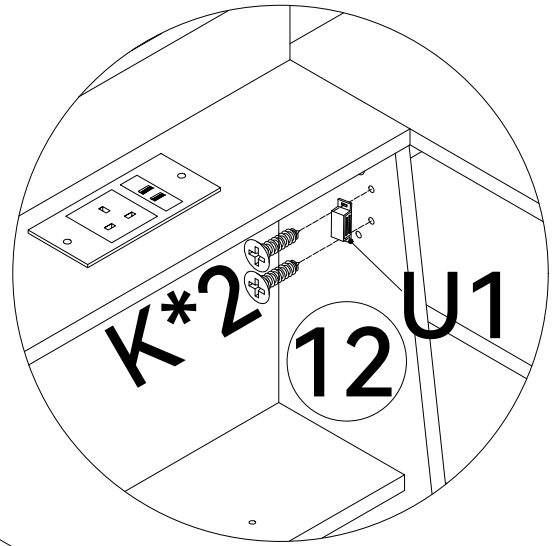

P	4x20		8PCS	S	M4		1PC	Q	4x25	
----------	------	---	------	----------	----	---	-----	----------	------	---

ASSEMBLY INSTRUCTIONS

13









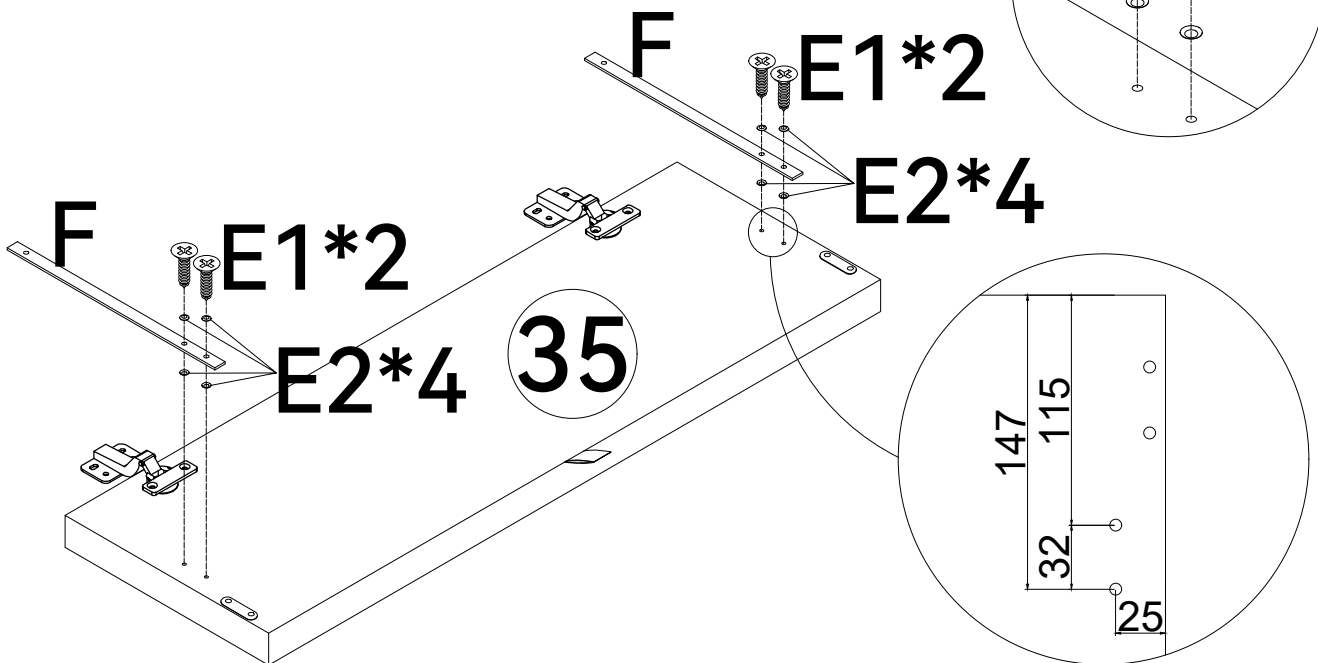
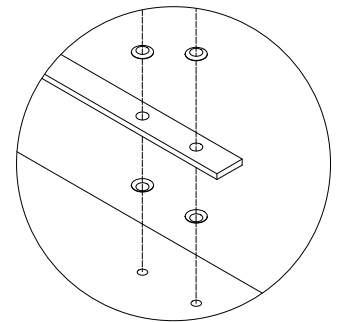
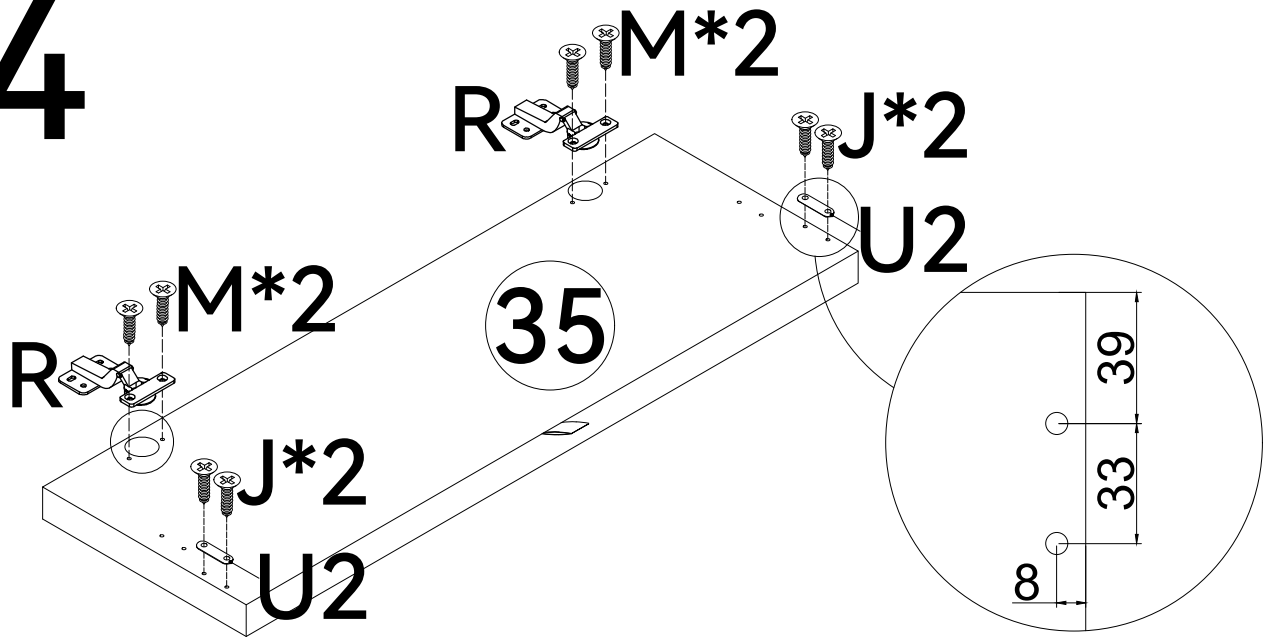

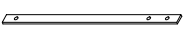

K	3x16		4PCS	J	3x14	
U1		 U1  U2	2PCS	M	3.5x14	
S	M4		1PC	N	3.5x16	

ASSEMBLY INSTRUCTIONS

14





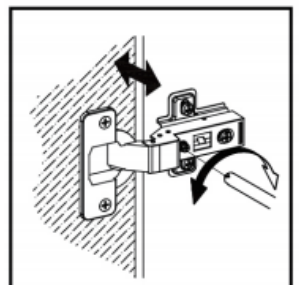
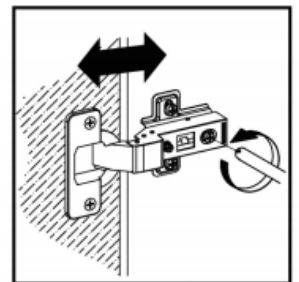
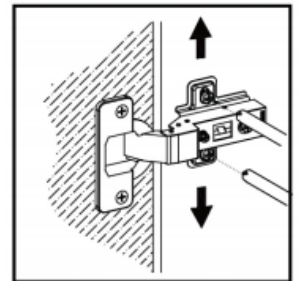
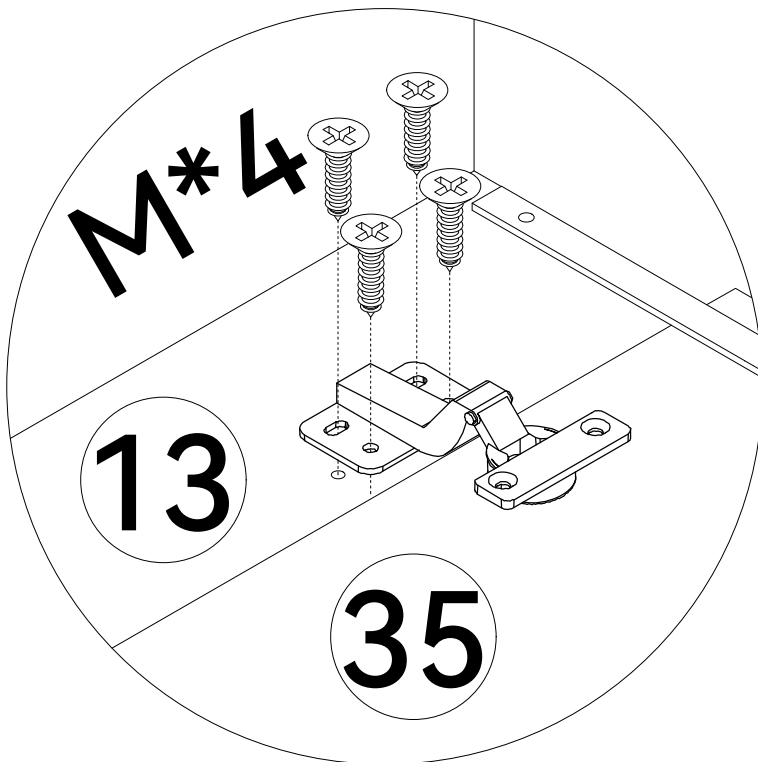
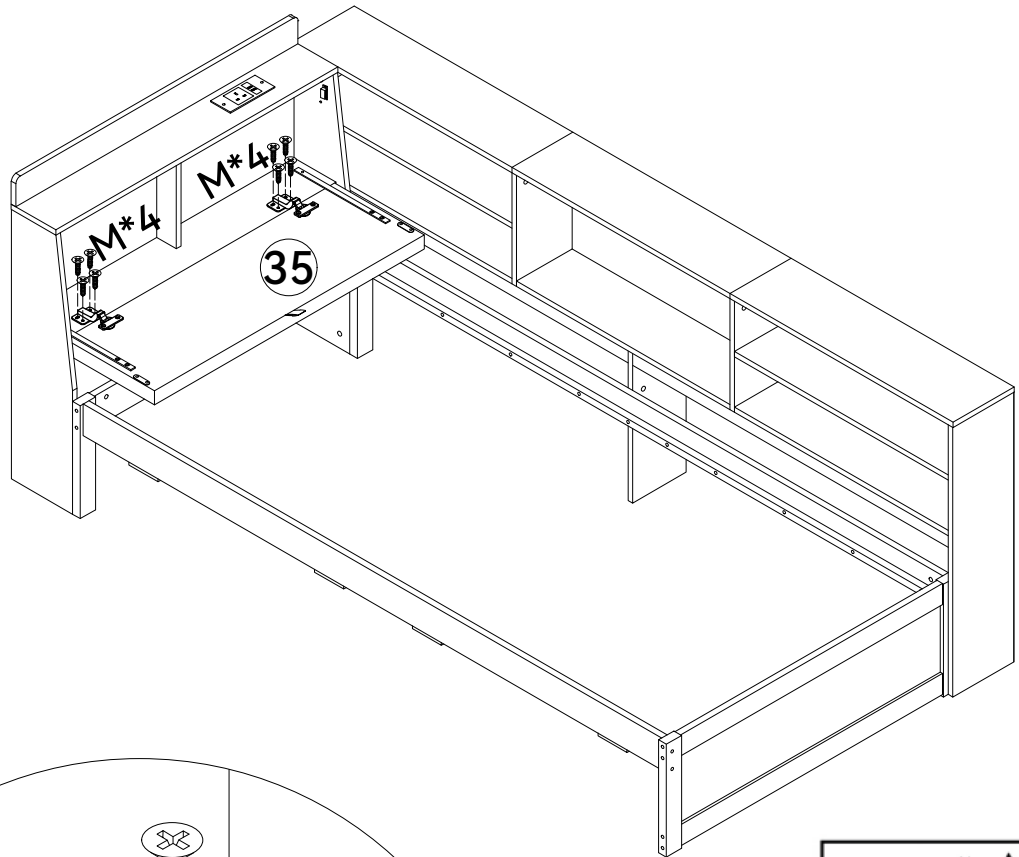

E	E1  E2  (3.5x18)	4PCS	M	3.5x14 	4PCS	K	3x16 	
F		2PCS	R		2PCS	N	3.5x16 	
J	3x14 	4PCS	U2	 U1  U2	2PCS	S	M4 	1PC

ASSEMBLY INSTRUCTIONS

15





M	3.5x14		8PCS	J	3x14	
S	M4		1PC	K	3x16	
				N	3.5x16	

ASSEMBLY INSTRUCTIONS

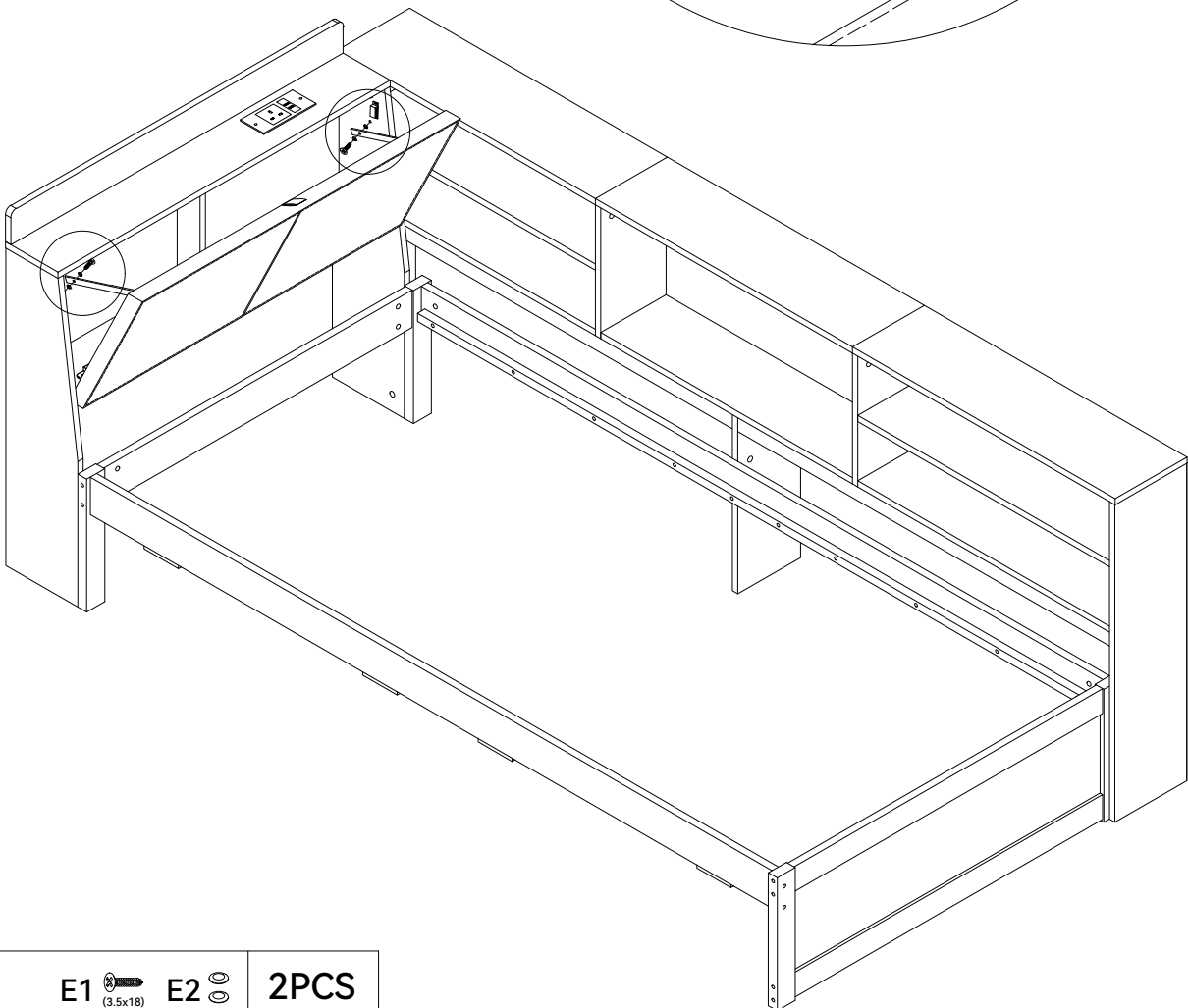
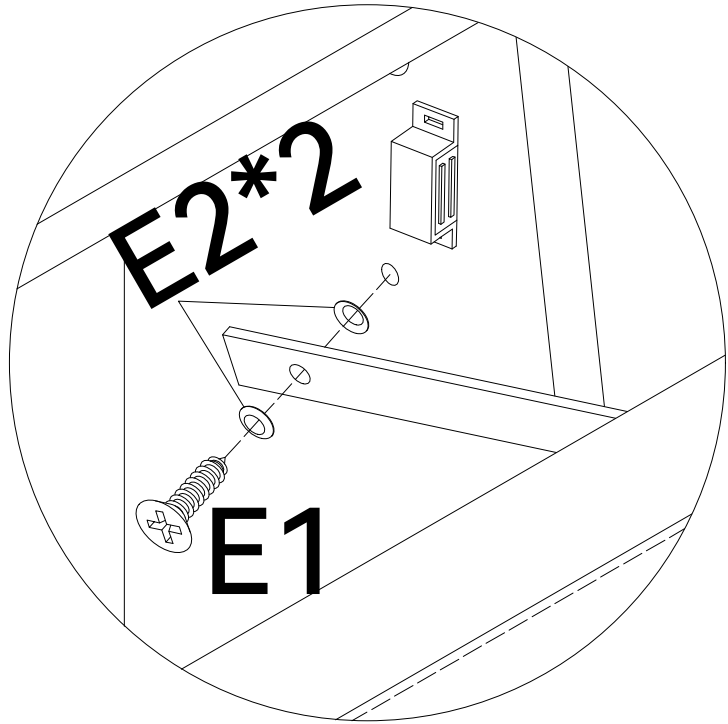
16



E	E1  E2 	2PCS
S	M4 	1PC

ASSEMBLY INSTRUCTIONS

17

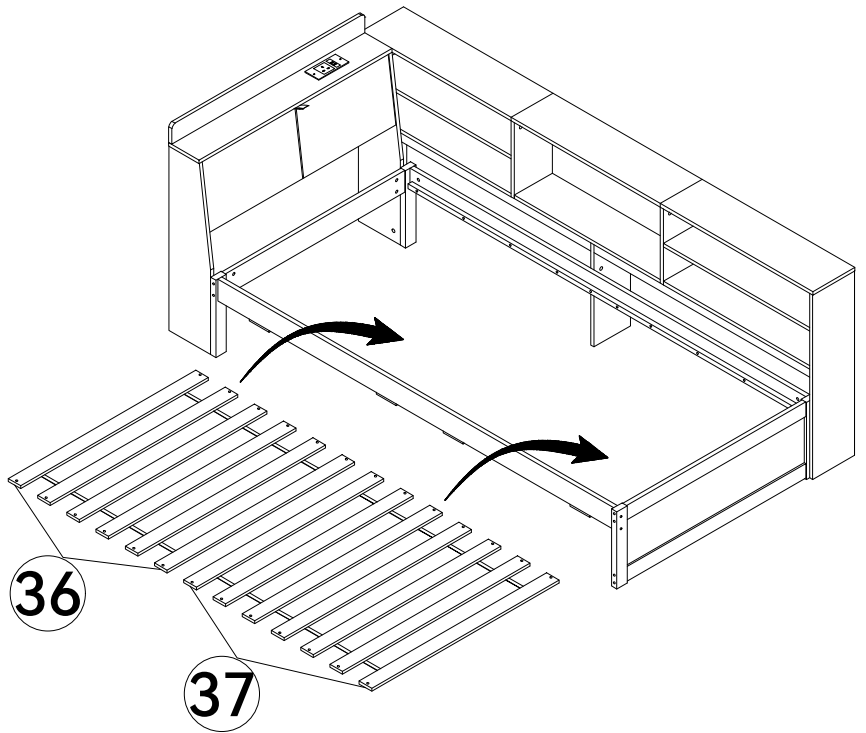
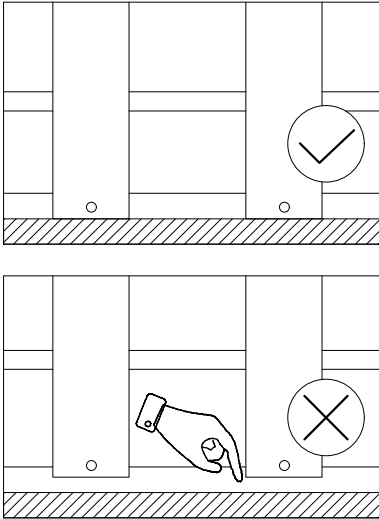

"IMPORTANT NOTE: When installing the bed slats, they should be flush against the bed frame, avoiding any gaps between the slats and the frame to ensure sufficient stability."

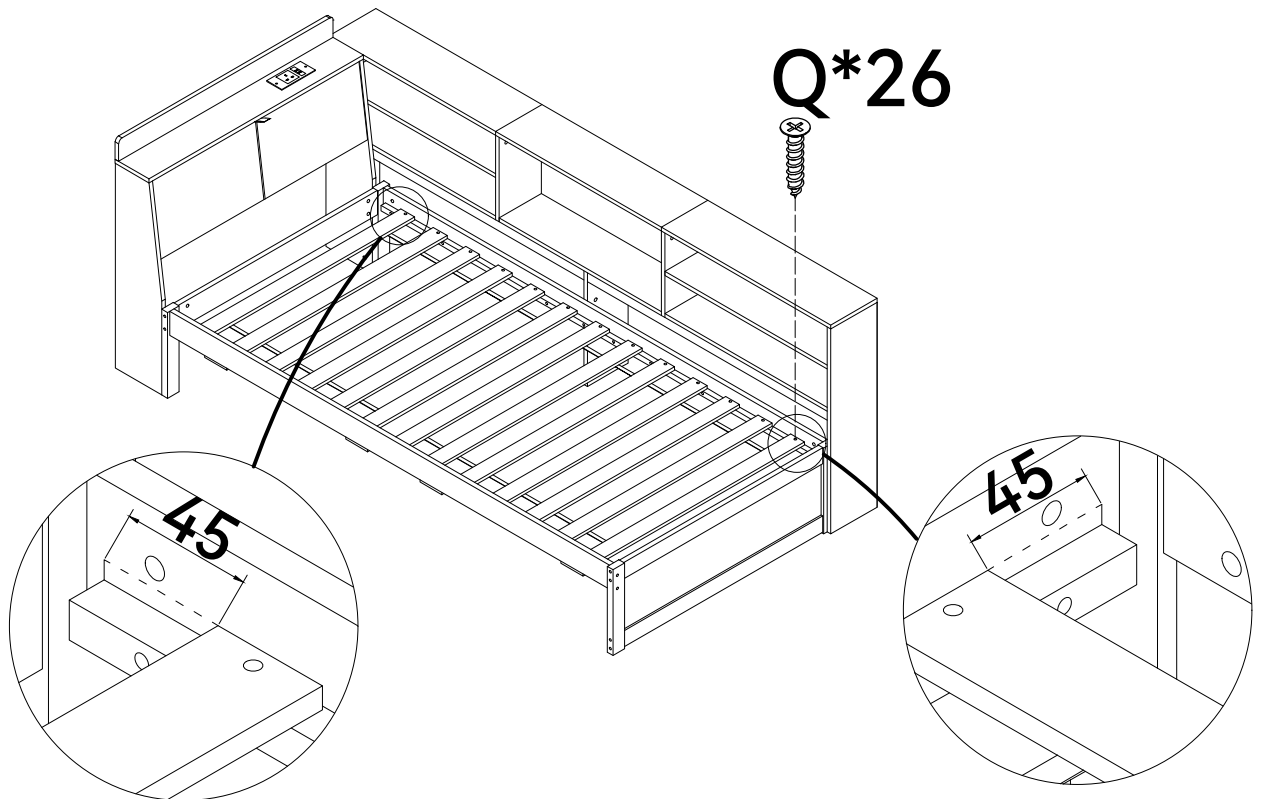





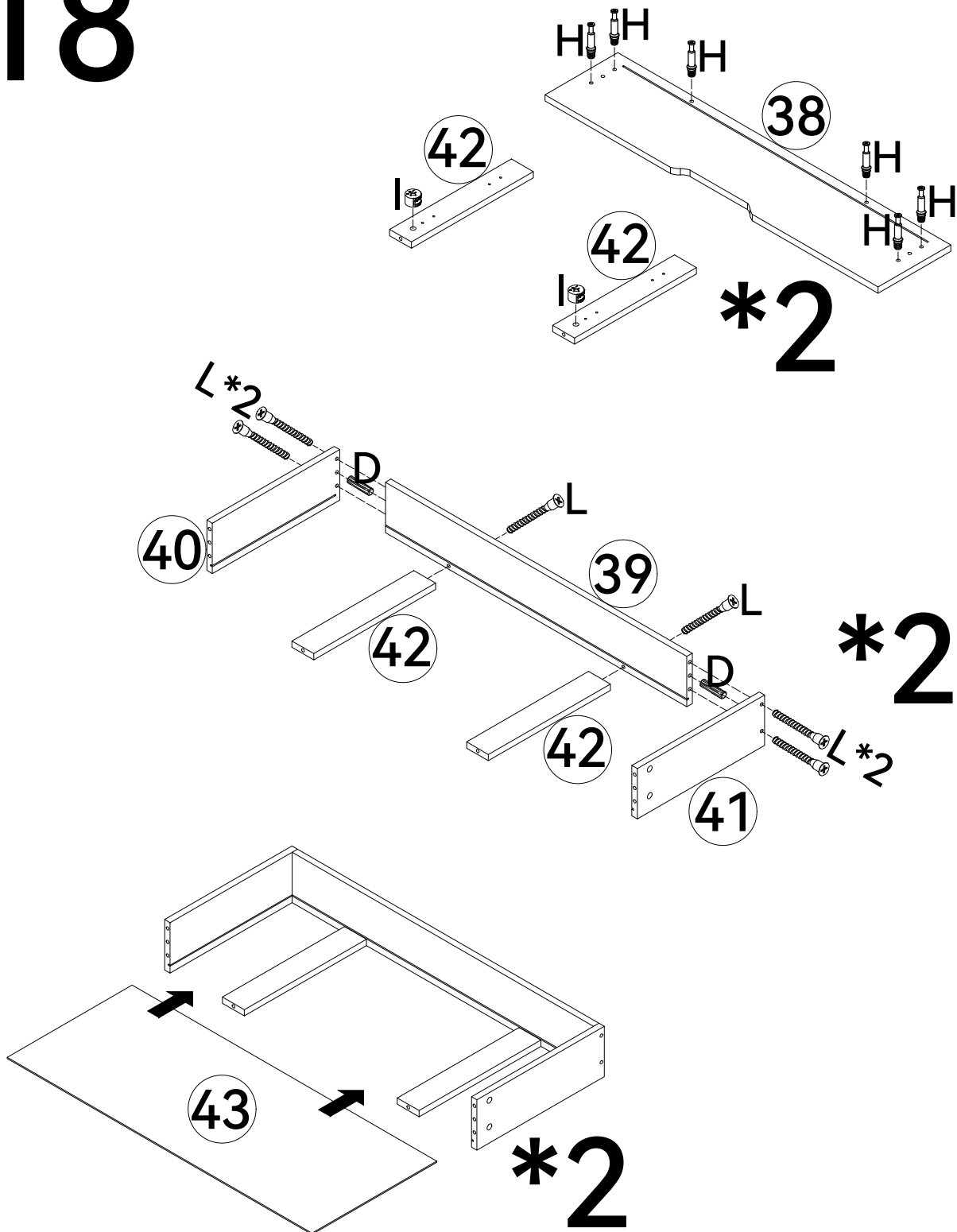

Q	4x25		26PCS	S	M4		1PC	P	4x20	
----------	------	--	-------	----------	----	--	-----	----------	------	--

ASSEMBLY INSTRUCTIONS

18



D	∅8x30		4PCS	L	5x40		12PCS	X	∅8x50		
H			12PCS	I			4PCS	S	M4		1PC

ASSEMBLY INSTRUCTIONS

19

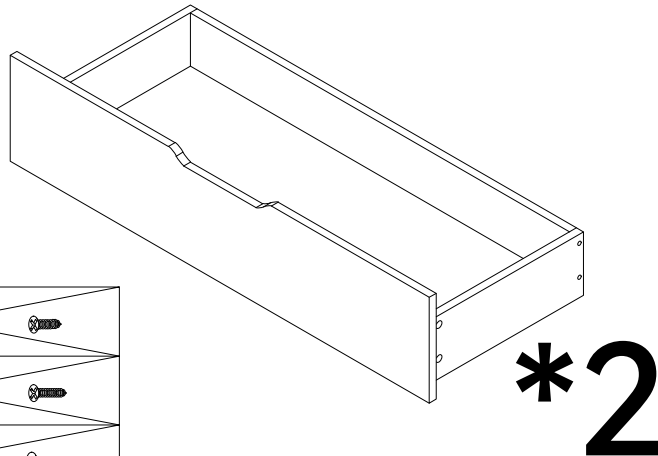
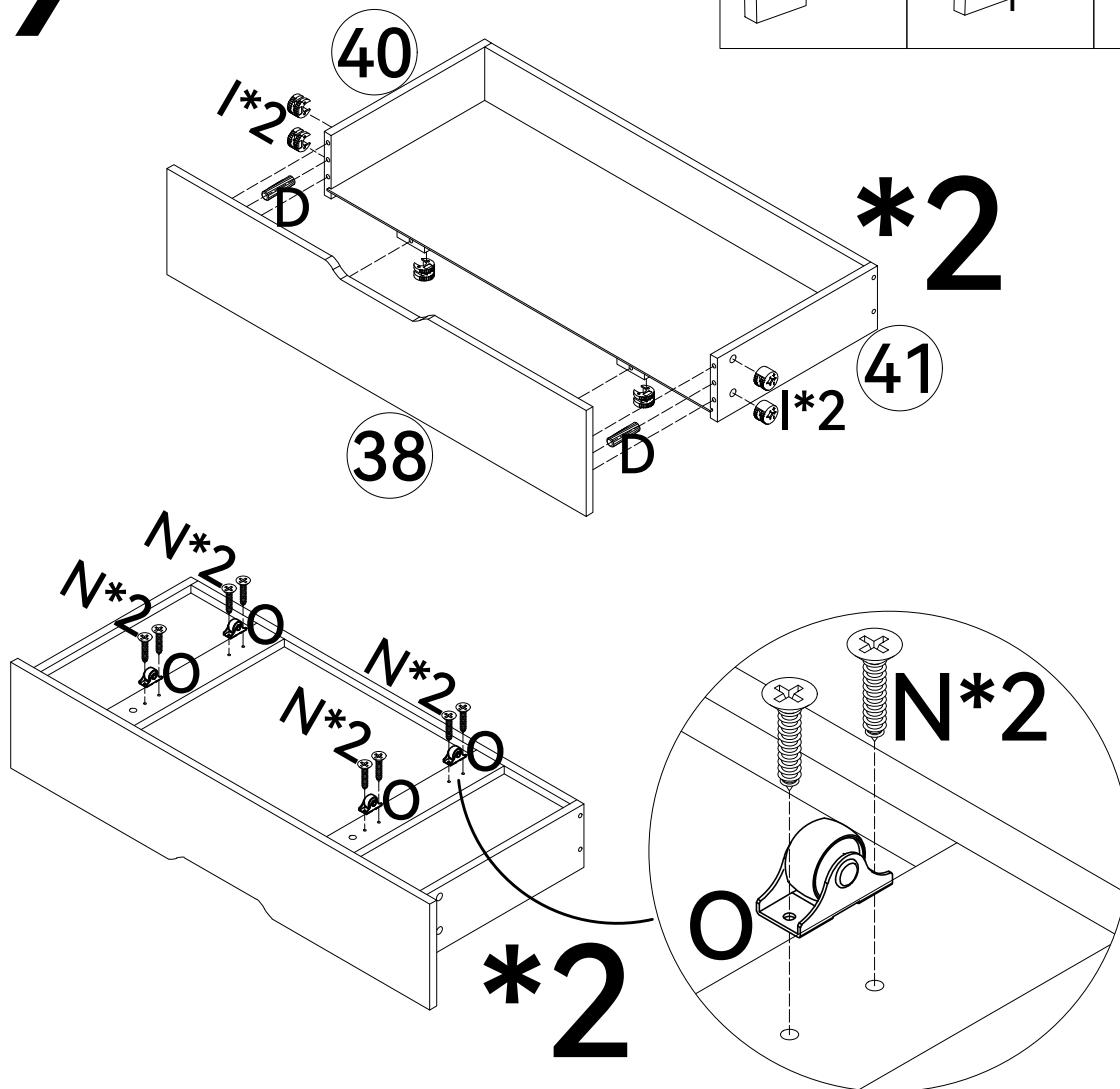
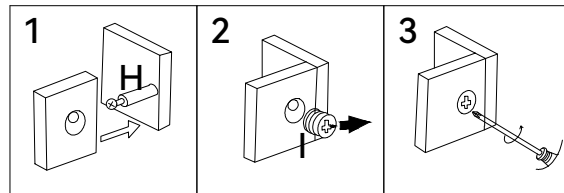

D	∅8x30		4PCS
I			8PCS
N	3.5x16		16PCS
O			8PCS
S	M4		1PC

J	3x14	
K	3x16	
M	3.5x14	
X	∅8x50	

ASSEMBLY INSTRUCTIONS

20

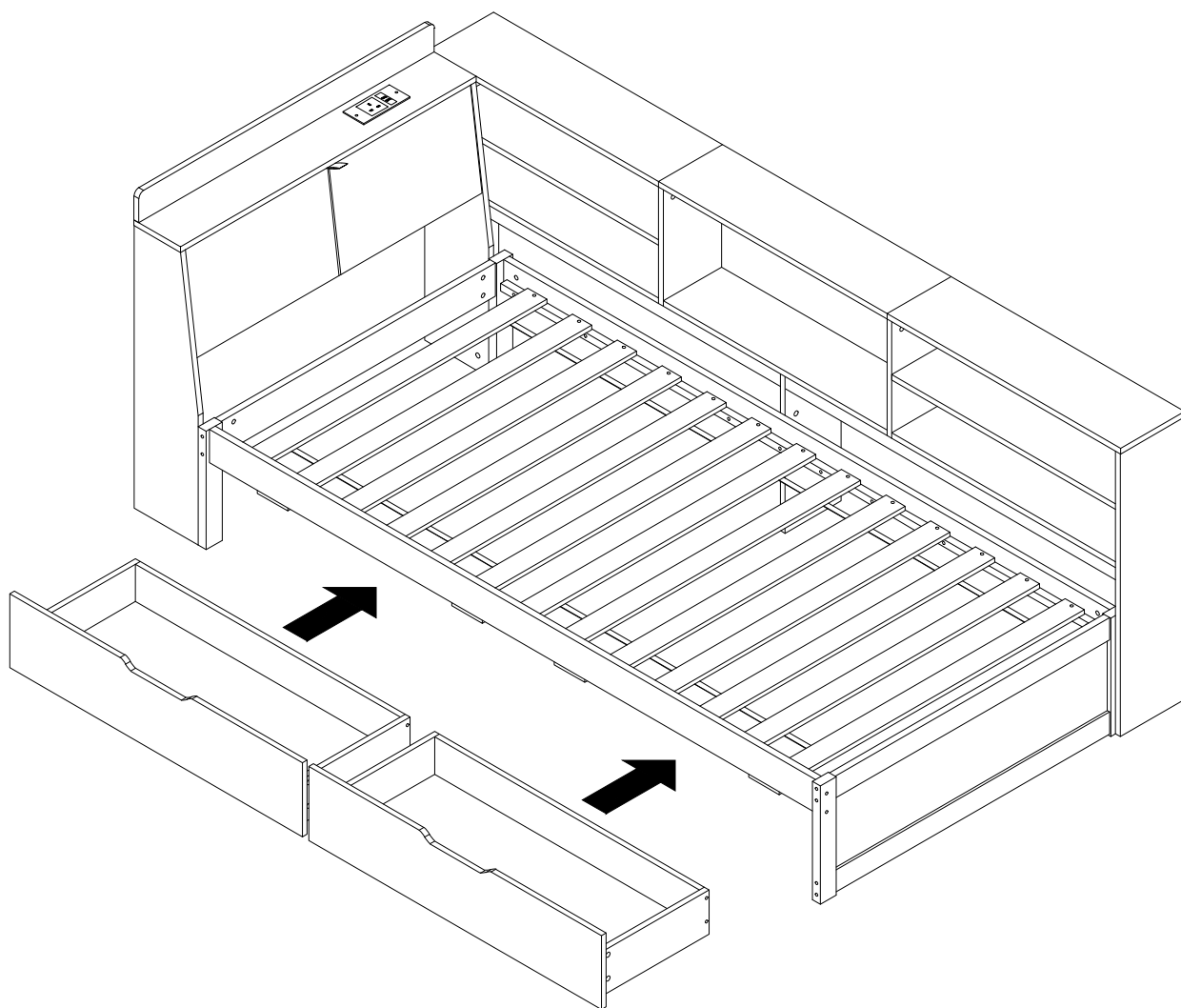

Certificate of Compliance

The Restriction of the Use of Certain Hazardous Substances in Electrical and Electronic Equipment Regulations 2012 (S.I. 2012 No. 3032) and its amendment.

Issue Date: Nov.27, 2025

Company Name	: GUANG TAI ENTERPRISE CO.,LTD
Address	: Rm402,Bldg 4,No.2 Dapianmei Rd.Dapianmei Village,Daling shang DONGGUAN GUANGDONG
Manufacturer	: GUANG TAI ENTERPRISE CO.,LTD
Address	: Rm402,Bldg 4,No.2 Dapianmei Rd.Dapianmei Village,Daling shang DONGGUAN GUANGDONG
Sample Name	: Furniture Power Distribution Unit
Sample Model	: JN 02-00-21Y;JN 02-00-111Y;JN02-00-112Y;JN02-00-212Y; JN 02-00-22Y;JN 00-00-02KY;JN00-00-03KY;JN00-00-03Y; JN 00-00-04KY;JN00-00-04Y;JN02-00-113KY; JN 02-00-113Y;JN02-00-23Y; JN02-00-23KY

This Declaration of Conformity is based on a test procedure or an evaluation of the above-mentioned product. This is to certify that the above-mentioned product is in compliance with the According to IEC63000:2018+AMD1:2017 and UKCA RoHS Regulations (SI 2012/3032) of The Restriction of the Use of Certain Hazardous Substances in Electrical and Electronic Equipment (Amendment) Regulations .

It is only valid in connection with the test report (Report No.: COBO25110737-R1)



Signed for and on Behalf of COBO

Sam Xie

Sam Xie, Technical Manager

GUANGDONG TI-COBO TESTING CO.,LTD.

EA601, Yishi Building No.9,Zongbu 2nd Road,Songshan Lake Sci.&Tech. Park, Dongguan, Guangdong, China

Tel:86-769-26622261 Fax: 86-769-26622012

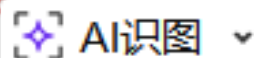



China

Attestation of Conformity

No. N8AUK 128892 0004 Rev. 00

Holder of Attestation: **GUANG TAI ENTERPRISE CO., LTD.**

Rm 402, Bldg 4, No.2 Dapianmei Rd.
Dapianmei Village, Dalingshan
523000 Dongguan, Guangdong
PEOPLE'S REPUBLIC OF CHINA

Product: **Multiple Socket Outlets
(Furniture Power Distribution Unit)**

This Attestation of Conformity is issued on a voluntary basis according to the Electrical Equipment (Safety) Regulations 2016 relating to electrical equipment designed for use within certain voltage limits. It confirms that the listed equipment complies with the principal protection requirements of the regulation and is based on the technical specifications applicable at the time of issuance. It refers only to the particular sample submitted for conformity assessment.
For details see: www.tuvsud.com/ps-cert

Test report no.: 6810024021201

Date, 2025-01-10

(Michael Xu)

Page 1 of 2

This Attestation does not replace the regulatory UK Declaration of Conformity (DoC) and does not allow for UKCA marking. After preparation of the necessary technical documentation and establishing compliance to requirements of all applicable regulations, the manufacturer may sign a DoC and apply the UKCA marking. The DoC is issued under the sole responsibility of the manufacturer.





China

Attestation of Conformity

No. E8AUK 128892 0005 Rev. 00

Holder of Attestation: **GUANG TAI ENTERPRISE CO., LTD.**

Rm 402, Bldg 4. No.2 Dapianmei Rd.
Dapianmei Village, Dalingshan
523000 Dongguan, Guangdong
PEOPLE'S REPUBLIC OF CHINA

Name of Object: **Power supply
(Furniture Power Distribution Unit)**

Model(s): **JN00-00-02KY, JN02-00-23KY, JN02-00-24KY,
JN02-00-23Y, JN02-00-24Y, JN02-00-21Y,
JN00-00-04KY, JN00-00-03KY, JN02-00-22Y,
JN02-00-22YM, JN02-00-23YM, JN02-00-23-KYM**

**Description of
Object:**

Ratings:
Input: 250VAC, 50Hz, Max 13A, Max 2990W
USB A1/USB A2 Output: 5.0VDC, 2.1A, 10.5W Max
Total USB output: 5.0VDC, 2.1A, 10.5W Max
Protection Class: I

**Tested
according to:**

EN 55032:2015/A1:2020
EN 55035:2017/A11:2020
EN IEC 61000-3-2:2019/A1:2021
EN 61000-3-3:2013/A2:2021
BS EN 55032:2015/A1:2020
BS EN 55035:2017/A11:2020
BS EN IEC 61000-3-2:2019/A1:2021
BS EN 61000-3-3:2013/A2:2021

This Attestation of Conformity is issued on a voluntary basis according to the Electromagnetic Compatibility Regulations 2016 relating to electromagnetic compatibility. It confirms that the listed apparatus complies with the principal protection requirements of the regulation and is based on the technical specifications applicable at the time of issuance. It refers only to the particular sample submitted for conformity assessment. For details see: www.tuvsud.com/ps-cert

Test report no.: 657602423601

Date, 2025-01-13

(Laurent Yuan)

Page 1 of 1

This Attestation does not replace the regulatory UK Declaration of Conformity (DoC) and does not allow for UKCA marking. After preparation of the necessary technical documentation and establishing compliance to requirements of all applicable regulations, the manufacturer may sign a DoC and apply the UKCA marking. The DoC is issued under the sole responsibility of the manufacturer.

**UK
CA**