

# Assembly Instructions

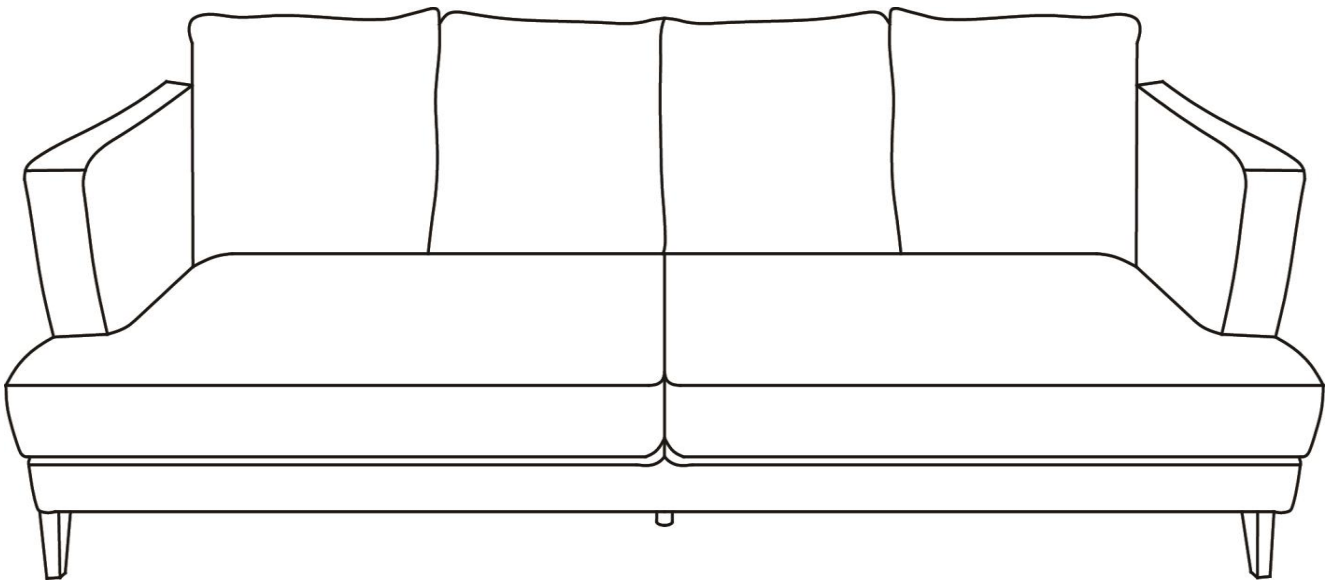

**Caution: You must read this before you proceed**

## SOFA



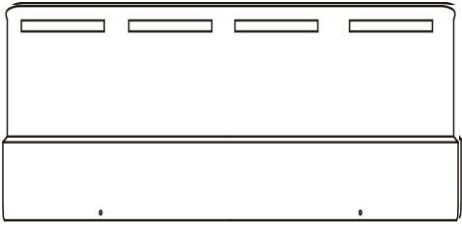
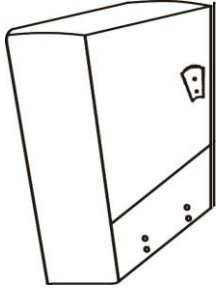
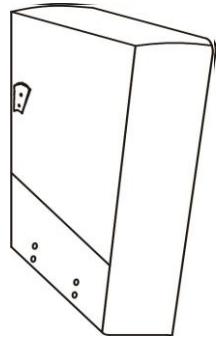
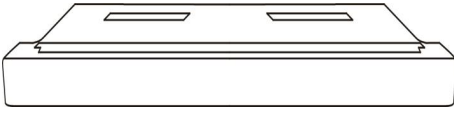
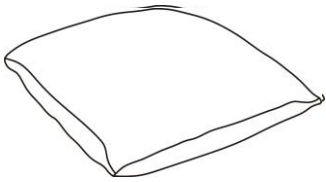
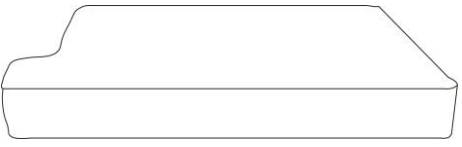
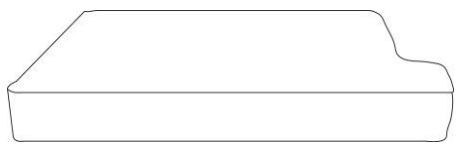





# Part List

Label	Picture	Description	QTY
A	 A line drawing of a rectangular backrest with four horizontal slots near the top and a base with two small circular indentations.	Backrest	1
B	 A line drawing of a trapezoidal left armrest with a small notch on the top edge and three circular indentations on the bottom edge.	Left Armrest	1
C	 A line drawing of a trapezoidal right armrest, a mirror image of part B, with a small notch on the top edge and three circular indentations on the bottom edge.	Right Armrest	1
D	 A line drawing of a rectangular seat with two horizontal slots on the top surface.	Seat	1
E	 A line drawing of a square-shaped back cushion with a slightly raised edge.	Back Cushion	4
F	 A line drawing of a rectangular left seat cushion with a raised edge on the left side.	Left Seat Cushion	1
G	 A line drawing of a rectangular right seat cushion with a raised edge on the right side.	Right Seat Cushion	1

H		Sofa Leg	4
I		Middle Support Leg	1

## Hardware



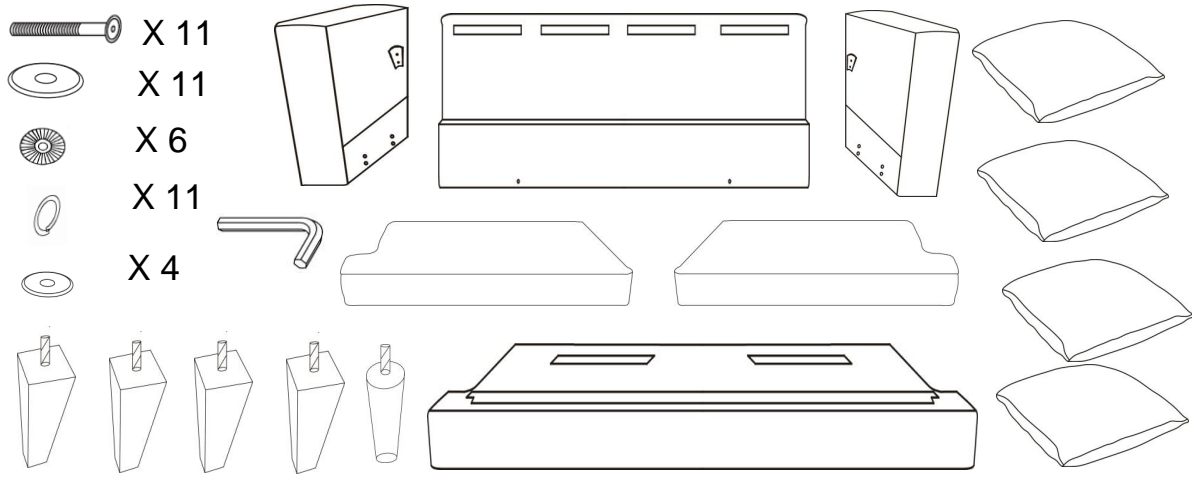

Label	Picture	Description	QTY
①		Bolt (M8*70MM)	11
②		Washer	11
③		Gasket	6
④		Allen Key	1
⑤		Spring Washer	11
⑥		Silicone Gasket	4

## Assembly Preparation

**Before Beginning Assembly:**



The diagram illustrates the assembly preparation stage. On the left, a list of hardware items is shown with their quantities: 11 bolts (M8\*70MM), 11 washers, 6 gaskets, 11 spring washers, and 4 silicone gaskets. In the center, an Allen key is shown. On the right, the sofa's main frame is depicted with four legs (labeled H) and one middle support leg (labeled I) attached. The sofa is shown with its backrest and seat cushions, and a separate view shows the sofa with its base and backrest panels.

-  • **Read instructions, cover to cover-**
-  • **Have 2 adults on hand for assembly-**
-  • **Do not assemble on flooring or carpet-**
-  • **Assemble on a clean non-marring surface (packing foam)-**
-  • **Save all packaging until finished-**

# Assembly Steps

## Overview

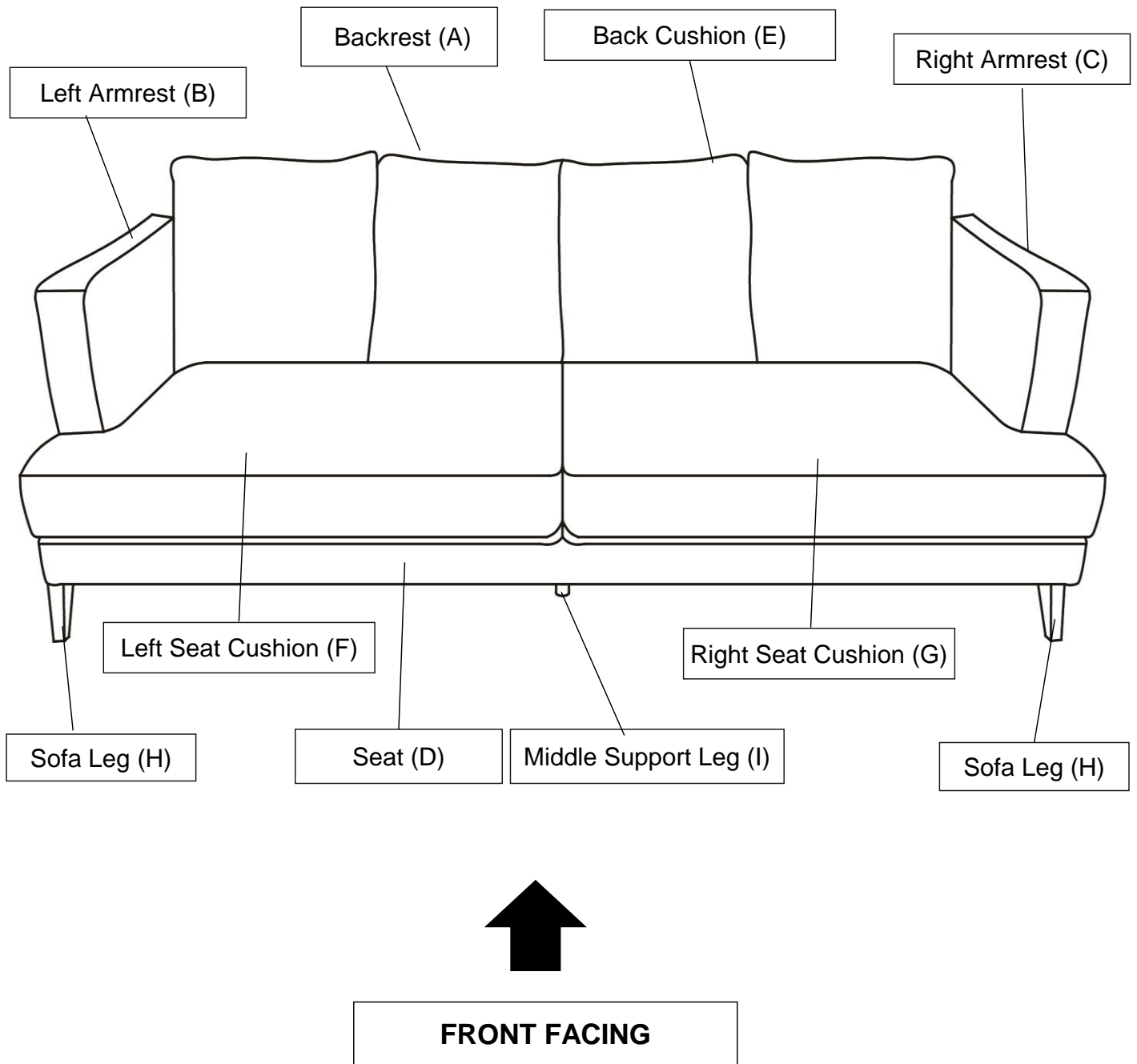

This Sofa has multiple parts and may require up to 60 minutes to assemble. To give you an overview of the Sofa parts, the above picture is to help you put the various parts into perspective. Please read through the instructions below to familiarise yourself with the parts and steps before assembly.

Note: It is recommended that you have an adult partner to assist during the entire assembly process.

## Step 1

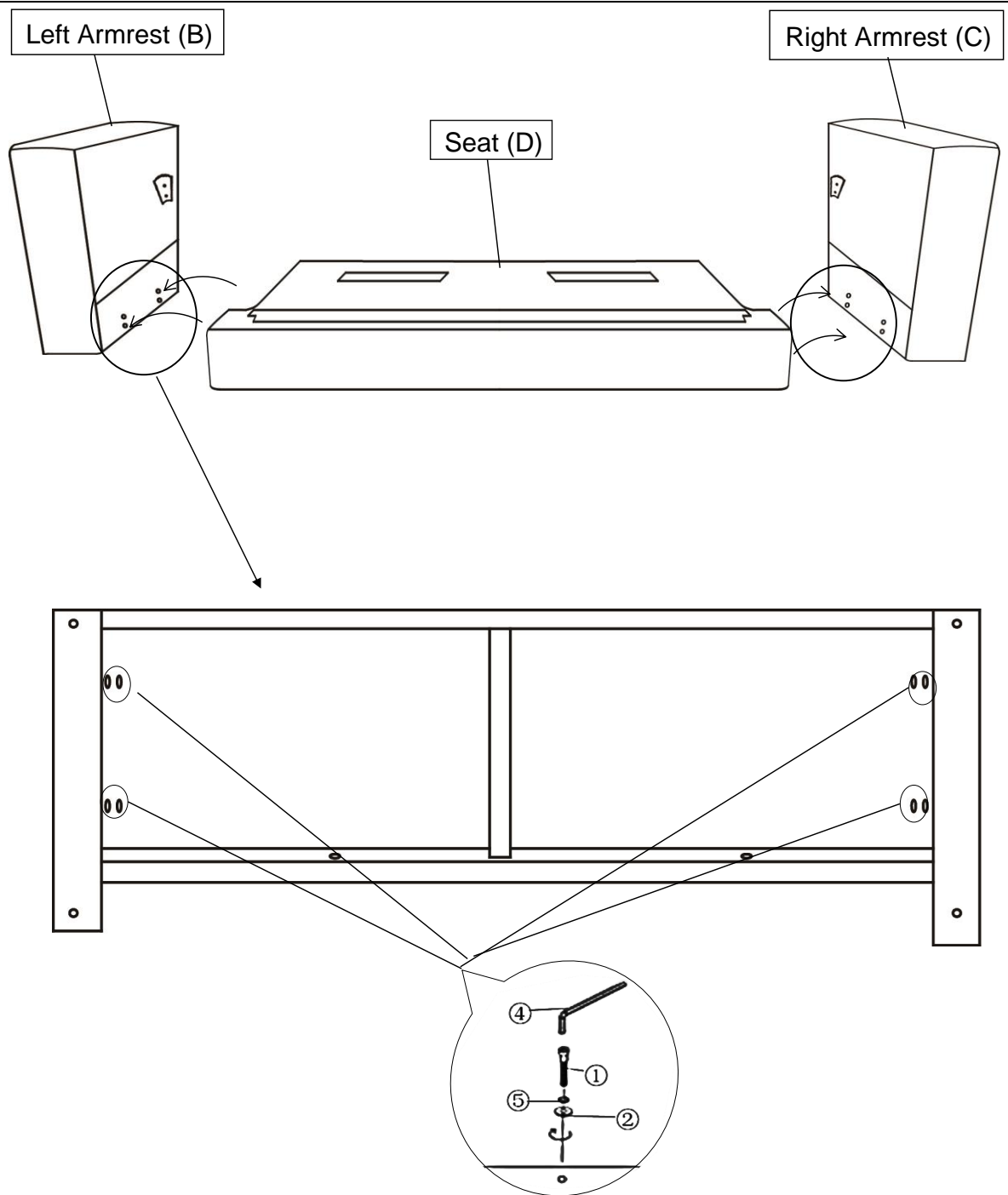

Open the carton and place all the parts on a clean, non-marring surface.

With the assistance of your partner, attach the Seat(D) to the Armrest(B&C) using Bolts(①), Spring Washers(⑤), Washers(②) and the Allen Key(④) as pictured above.

Assistance from an adult partner is needed for this assembly process.

**Tighten the Bolts fully in a sequential manner.**

**DO NOT fully tighten the Bolts in one go and then move on to the next.**

**Rather, In a sequential manner, gradually tighten each Bolt until all Bolts are evenly secured. This methodology will ensure maximum evenness once all Bolts are fully tightened.**

**Caution: Ensure that your fingers do not get caught or pinched in the assembly process.**

## Step 2

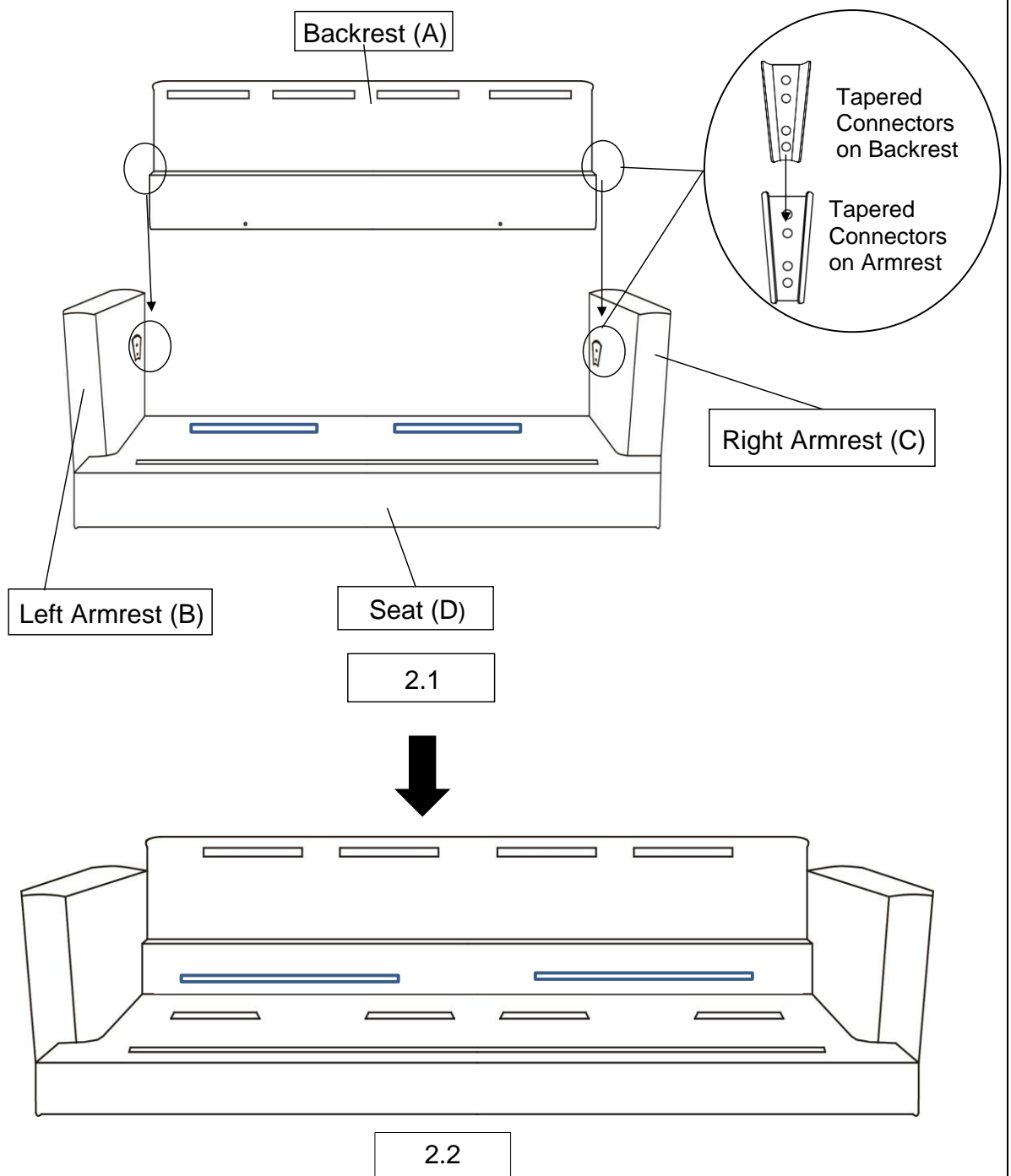

With the assistance from your adult partner:

2.1) Lift the Backrest(A) up, make sure the Backrest(A) is vertical and aligned to the Seat and Armrests. Align the Tapered Connectors on the Backrest(A) with those on the Armrest(B,C).

Your adult partner may need to push the Armrests inwards to the Backrest(A) to allow for better alignment.

Slip and Slide the Backrest, in a gradual and balanced manner into the Tapered Connectors.

2.2) Push the Backrest(A) downwards until it is fully slotted and locked into position.

**Note: Make sure the Tapered Connectors on the Backrest(A) lock into the Tapered Connectors on the Armrest(B&C) .**

**Fully locked position: Check and assess that the base of the Backrest(A) and Seat(D) are aligned and level.**

**Assistance from an adult partner is needed for this assembly process.**

### Step 3

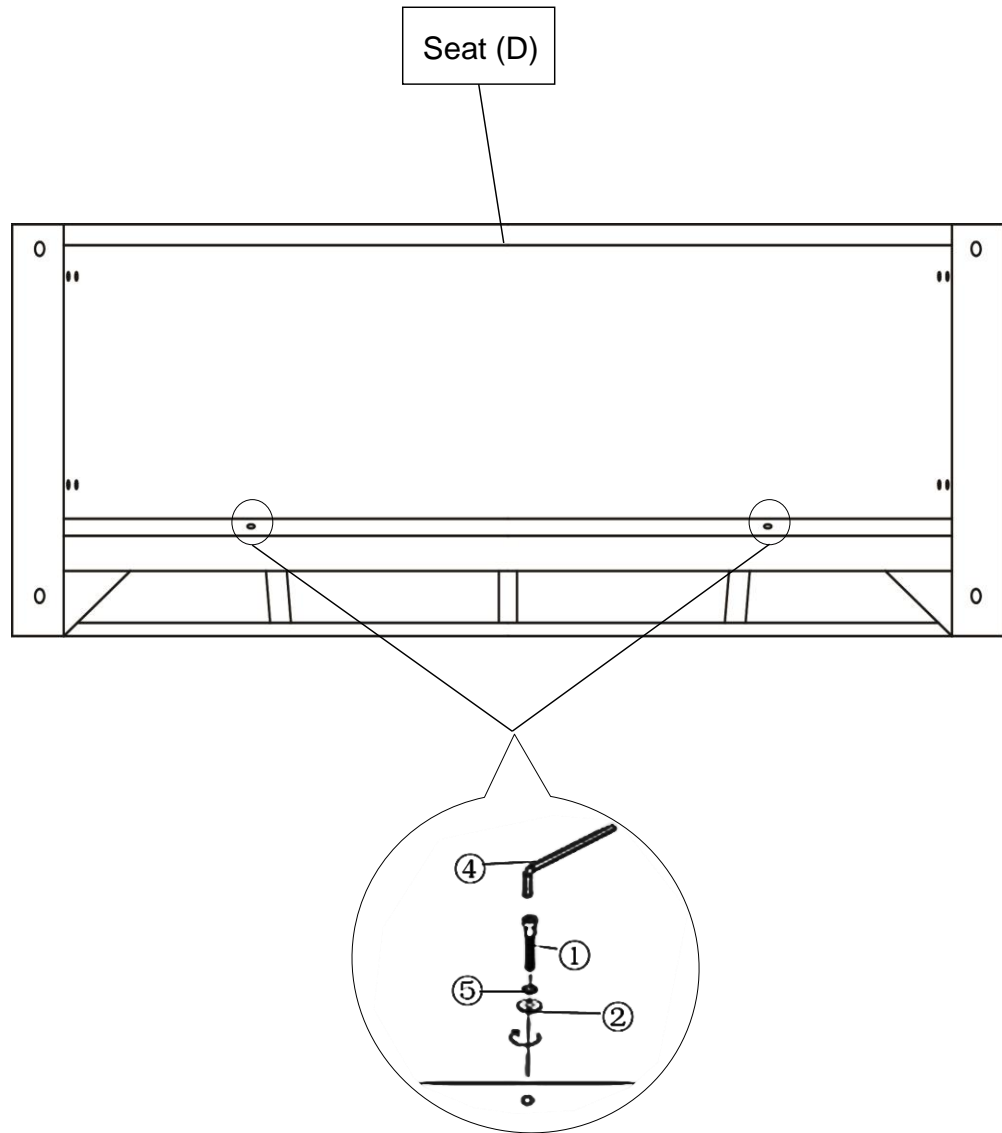

Tilt and lay the Sofa on its Backrest(A) onto a flat surface.

Attach the Seat(D) to the Backrest(A) using Bolts(①), Spring Washers(⑤), Washers(②) and the Allen Key(④) as pictured above.

**Tighten the Bolts fully in a sequential manner.**

**DO NOT fully tighten a Bolt in one go and then move on to the next.**

**Rather, In a sequential manner, gradually tighten each Bolt until all Bolts are evenly secured.**

**This methodology will ensure maximum evenness once all Bolts are fully tightened.**

**Note: If you can not insert the Bolts into position, please go back to Step 2 to "push the Backrest downwards".**

## Step 4

Use Silicon Gasket(⑥) and Gaskets (③) to achieve stability

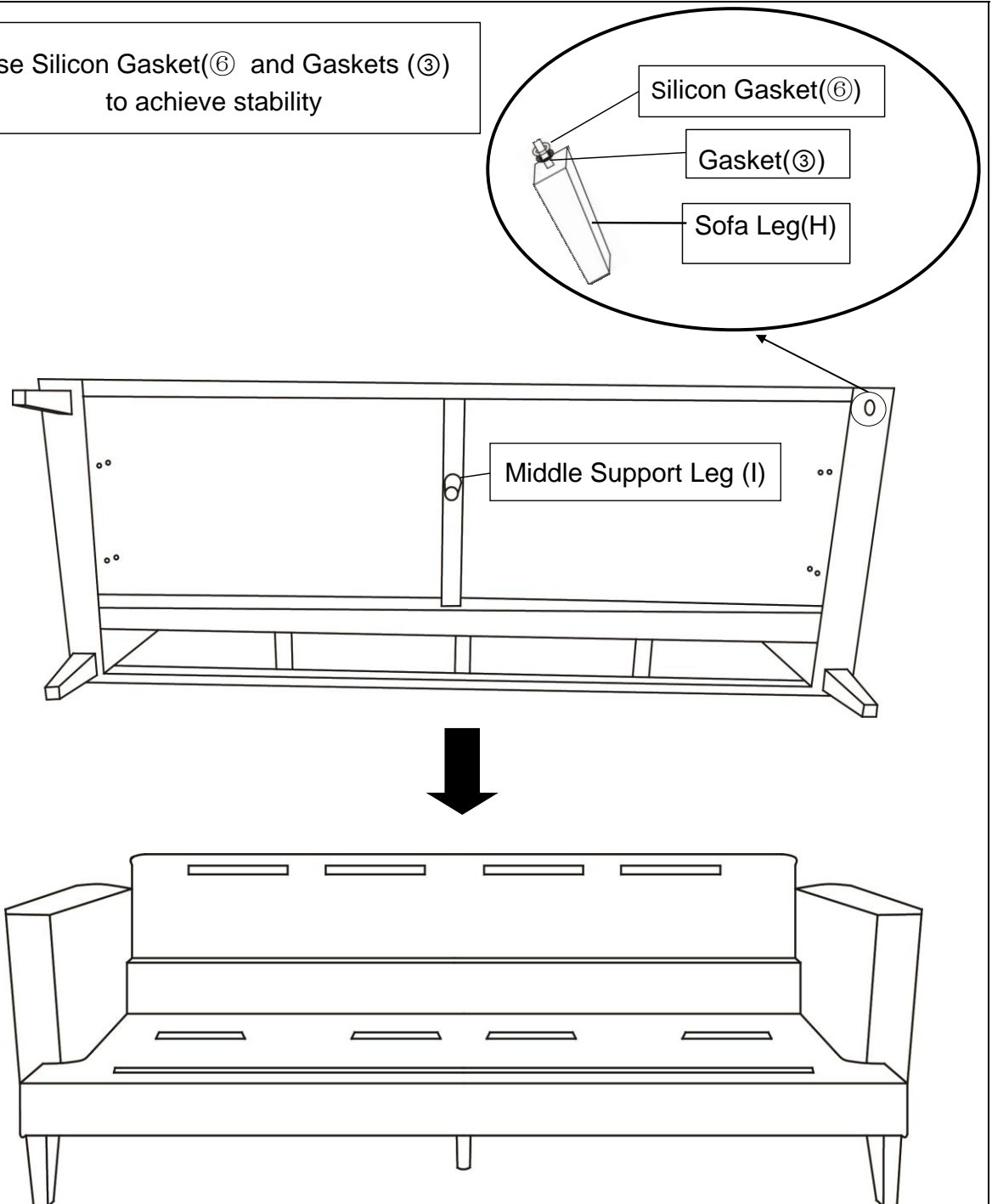

Install one of the Sofa Legs(H) into the Seat(D) by placing one Silicone Gasket (⑥) and one Gasket(③) onto the threaded stem.

Insert the threaded stem of the Sofa Leg(H) into one of the mounting positions of the Seat(D), then tighten by turning the Leg clockwise until it is completely secure.

Repeat the same step to install the remaining three Sofa Legs(H).

Install the Middle Support Leg (I) by placing one Gasket(③) on the threaded stem.

**Note: The use of Silicone Gasket (⑥) is to ensure you can turn the Sofa Leg (H) into the correct position. The use of Gaskets are OPTIONAL and are especially useful to help alleviate slight wobbles. Some Legs may need more than one whilst some legs may not need any.**

**Please keep the Allen key for future use, you may need to tighten the Bolts again with the Allen key if any part of the product loosens during use.**

Step 5

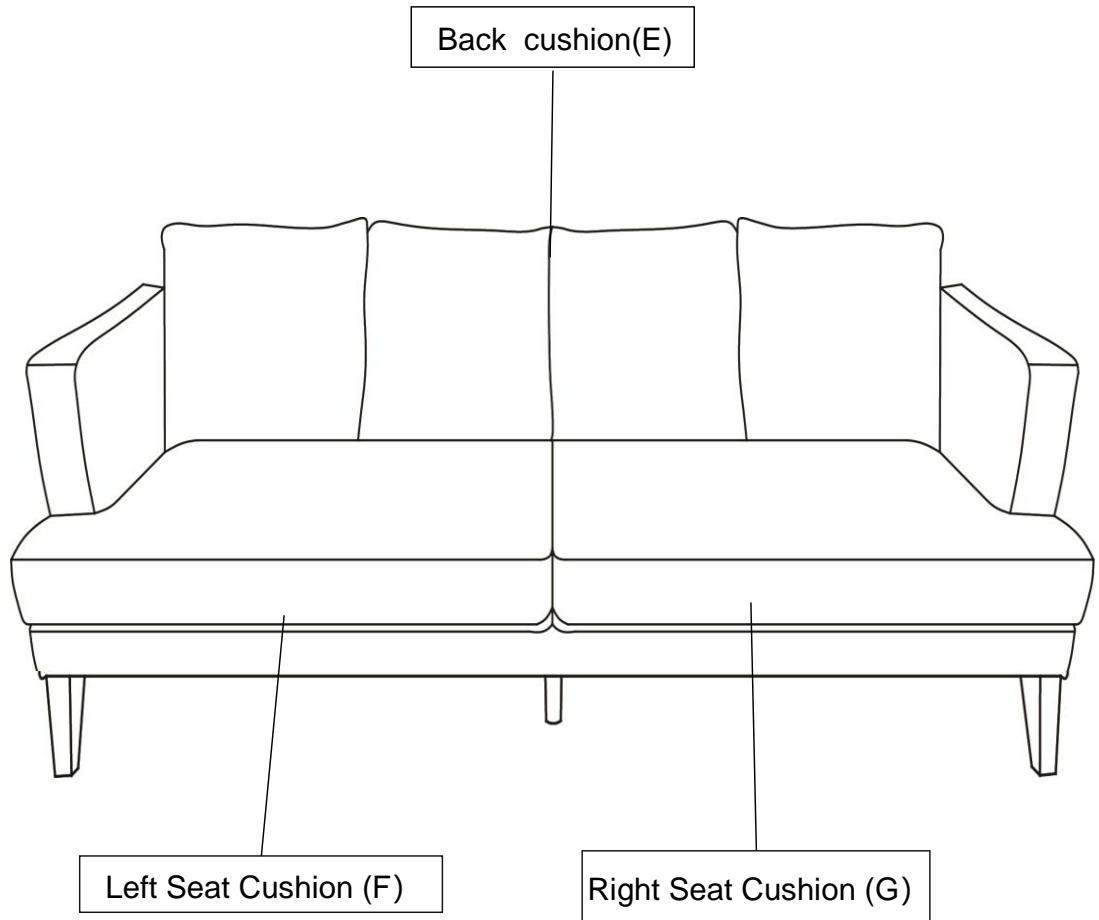

Place the sofa in an upright position, then place the Seat Cushions(F&G) and the Back Cushion (E) onto the Sofa.

Your Sofa is ready for use.

**This Sofa can only be used on a flat, level surface.**

## Care & Maintenance



- Do not put hot items directly on furniture surface



- Do not clean furniture with harsh cleansers or polish.



- Do not place furniture under direct sunlight.



- Do not place furniture near heating or cooling vents.



- Do not write on furniture without a padded barrier to protect the surface.



- Do not place furniture outside . For indoor use only .



- Not for commercial use. For residential use only .



- Stains may be removed with mild soap solution and damp cloth.



- Children should not climb or jump on the furniture.



- Dust and pick-up spills using a clean, non-colored, lint-free cloth .