

Intelligent Toilet Manual

CONTENT

Thanks very much for using our products.

Please read and follow the instructions carefully before using. Save the instructions in proper place and do not loss it.

There would be a little difference from each item.

The shape of item in the manual is for reference only.

The company will not notify you of functional differences due to product upgrades and other reasons.

If there are objections, our company reserves the final interpretation right of the manual.

List of Functions	01
List of Configurations	02
Safety	02
Warning	03
Using Notes	07
Names of parts	09
Side Knob operation	09
Digital display	10

Instructions

Check-lists before initial start-up	10
Remote Control	12
Detail of Remote Control	13
Optional Featured Function	15
Operating Note	16























Routine Maintenance

Daily cleaning	18
Installation	19
Not use in a long time	21
Replacement of battery	21

Freeze in Case

Problem & Solution

Specification

Main Functions		
Rear Cleaning		Rear cleaning by output water from nozzle
Bidet		Bidet cleaning for ladies
Moving Spray		More cleaning effective by moving nozzle
Hot Cold Massage		The washing water alternates between hot and cold, to achieve the effect of massage.
Water Pressure Massage		The pressure of the cleaning water alternates to achieve the effect of massage.
Children		Press one button to activate full functional auto wash without seated sense.
Nozzle Arm Position		Adjust the nozzle arm forward and backward to get the best washing position to fit the user.
Seat Heating		The cover can be kept in comfortable temp. by micro CPU control
Warm Wind Drying		Automatic drying after cleaning
Soft Close		Dampers cushion the toilet seat and lid noiselessly and slow down closing.
Auto-Sensor		The toilet will stand by while people seat on the inductive area
Smart Flushing		Auto flush will work after the user leaving the seat after sitting down for more than 10 sec, or in one-key mode or pressing the flush button.
Nozzle Self-cleaning		The spray arm and nozzle will be self-cleaned with fresh water.
Energy Saving		Set the Eco mode to save the energy.
Pressure Adjusting		Press the water pressure adjustment button to cyclically set the washing intensity.
Instant Heating		The washing water will be instantly heated to the set temperature.
Power-off Flushing		The flushing can still work while the power is off. (Optional function, subject to each model)
Auto Open		When Auto open is enabled, the lid and seat will automatically open when someone approaches about 30 CM close to the toilet (Optional function, subject to each model)
Temp. Protection		The nozzle washing will be deactivated in case that water is cut or off.
Foot Sensor Flushing		The flushing will work once time while the foot meeting the area of sensor at the bottom of right side (subject to product).
Foot Sensor		The lid will automatically open while the foot meeting the area of sensor at the bottom of right side (subject to product).
UV Sterilization		the UV light will be activated to work for 1 min when the seat cover is close after a seated status for more than 1 min (optional function, subject to model)
Aromatherapy deodorization		Aromatherapy deodorization factor enter into air, encircle and exterminate peculiar smell molecule spontaneously, decompose and disorganize the peculiar smell molecule in the air, reduce the stink.
Ambient lighting		Colorful ambient lighting, more than 10 colors and several modes can be switchable.

		Functions For Each Type																						
Function Type	Function																							
	Rear	Bidet	Move	Spa	Pressure adjust	Warm seat	Warm wind	Deodorization	Soft close	Power flush	Power saving	Power clean	Nozzle clean	Smart flush	Press adjust	Night light	Instant heating	Seat sensor	Auto cover	Auto sensor cover	Foot sensor flush	Foot sensor shield	UV-Sterilization	
A	✓	✓	✓	✓	✓	✓	✓	✓	✓	✓	✓	✓	✓	✓	✓	✓	✓	X	X	X	X	X	X	X
B	✓	✓	✓	✓	✓	✓	✓	✓	✓	✓	✓	✓	✓	✓	✓	✓	✓	✓	X	X	✓	X	X	X
C	✓	✓	✓	✓	✓	✓	✓	✓	✓	✓	✓	✓	✓	✓	✓	✓	✓	✓	✓	✓	X	X	X	X
H	✓	✓	✓	✓	✓	✓	✓	✓	✓	✓	✓	✓	✓	✓	✓	✓	✓	✓	✓	✓	X	✓	✓	X
J	✓	✓	✓	✓	✓	✓	✓	✓	✓	✓	✓	✓	✓	✓	✓	✓	✓	✓	✓	✓	X	X	✓	✓

This list consists the full functional features. For the model you choose, there will be optional function, subject to model.

Safety Notes

Please read and follow the instructions carefully before installation and using.

The instructions must be followed while using the product.

WARNING -Avoid accident of electric shock

1. Do not use the product in a wet environment.
2. Do not drop the remote control into bath tub or sink or any liquid.
3. Do not put water onto product or electric plug.

WARNING -Avoid accident of getting burnt, electric shock and fire



1. It requires someone to accompany while using the product for people who can not adjust the temperature correctly like children, elder, disabled, paraplegia, etc.. And please set the temp. to lowest level or shut the function down.
2. The product includes functions showed in this manual only. Please do not use extra devices unless we recommend.
3. Do not replace the wire or electric plug yourself while it is broken or dropped into water. The correct way is to call the professional maintenance staff to handle it or send it to a maintenance center.
4. Please ensure the wire would not be burnt.
5. Please do not use the product if you take sleeping pills or are over drinking , or feel drowsiness.
6. Please do not put anything into the hole or water tube.
7. Please do not use the product outdoors.
8. Please do not allow children play the product as toy.
9. Please use the new fittings and hose we supply. The old fittings and hose can not be reused.

Please Keep The Manual in place



Safety Notes

Please do read and follow the instructions carefully before using. They are about safety of person.

Symbols and meanings

 Warning	Ignoring this tag may cause serious injury or death.
 Caution	Ignoring this tag may cause injury or property loss.

Symbols and meanings

	Dismantling is forbidden.
	Must follow.

Warning



No splash

It is forbidden to drop any water and detergent on the product or the electric plug.

- May cause fire or electric shock.
- May cause breakage or leaking.

The smart toilet is an electric product. Please avoid splash and use it in a wet environment. Maintain air circulation when the product is used in bathroom.

- May cause fire or electric shock.

Set the electric socket as below

- May cause fire or electric shock if not follow the instructions.
- a. Please use a high-sensitivity and fast leakage switch for the circuit of the electric socket. Or to use insulated transformer (>1.5KVA, <3.0KVA).
- b. The electric socket should be installed 0.3m at least up to ground and away from the bath tub.

Must install the ground wire

- May cause electric shock without ground wire.

Attn: The electric resistance should be 4Ω and the diameter of the copper wire should be 1.6mm or above.

Using the product in bathroom

Make sure the power plug has been waterproofed with silica gel.

- May cause fire or electric shock without waterproofing.

Warning



No wet

Do not use the product in wet environments.

- May cause fire or electric shock.



No disassemble

Dismantle, repair or remould the product are forbidden

- May cause fire or electric shock.



Forbidden

Stop using the product while it has malfunction

- Please pull out the plug and turn off the inlet valve.

Malfunction:

Leakage
Dehiscence
Abnormal sound & smell
Fuming & abnormal heating
Blocking

- Keep using the product while it has malfunction may cause fire or electric shock or leakage.



Forbidden

Do not use a unsteady socket

- May cause fire or electric shock.



Forbidden

Do not use water sources other than city water

- May cause dermatitis.



No wet hand

Do not touch the electric with wet hands.

- May cause electric shock.



Forbidden

Do not damage the electric wire/connected toilet

Do not pull, process, heat, forcefully bend the electric wire connected toilet.

Do not put heavy item onto the electric wire, connected toilet.

- Ignoring the breakage and keep using product would cause fire, electric shock or short circuit.



Forbidden

Do not use the power socket with lots sockets

- Do not remould the wire we supply. That would cause fire or electric shock.



Forbidden

Do not use the AC 110V except

- May cause fire.

Warning



Must follow

PREVENT GETTING BURNT

- Please set the seat temp. to home temp. if seating in a long time.
- Please set the seat temp. to home temp. and set the drying temp. to the lowest level for special people.

Users people who can not adjust the temperature correctly like children, elder, disabled, paraplegia etc..

who take sleeping pills or over drinking or weary or drowsiness

Warning



Do not any fire thing get close to the product

No fire

- May cause fire.



Do not block the outlet of warm wind

Forbidden

- May cause fire, electric shock or breakage.
- Pay attention to children or the elder is using the product.



**Do not tackle the product strongly
Do not stand on the product or put heavy items on it**

Forbidden

- May cause breakage or injury.
- May cause leakage.



**The surface can be cleaned with neutral detergent only
Do not use things as below**

Forbidden

- (Bath detergent, domiciliary detergent, petrol, thinner, cleaning powder, nylon brush, etc.)
- May cause breakage or injury.
 - May cause leakage.



Do not dismantle the inlet filter while the inlet valve is on

Forbidden

- May cause leakage.



Do not bend the tube

Forbidden

- May cause leakage.

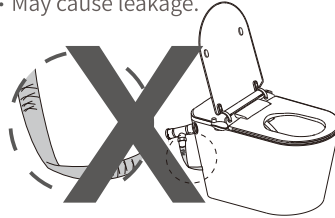

Do not drop into the toilet bowl

Forbidden

- May cause block & leakage.



Turn off the power if the product is not in use for a long time

Must follow

- Pull out the plug for safety.
- May cause dermatitis by rancid water.



Turn off the inlet valve while it is leaking

Must follow



Prevent the damage from being frozen

Must follow

- The inlet device and part of product would be damage by freezing and cause leakage.



Solidly install the inlet valve

Must follow

- May cause leakage if not to do.

Please keep proper home temp.



Plug the electric plug well

Must follow

- May cause fire if the plug is unsteady or not plugged well.
- Pull out the electric plug if the product not in use in a long time



**Please pull out the electric plug while the toilet is blocked
Reuse until the blockage is cleared**

Must follow

- May cause leakage while running the cleaning function if not pull out the electric plug.



Do not expose the product in direct sunlight

Must follow

- May cause damage of discoloration, aging and deformation.

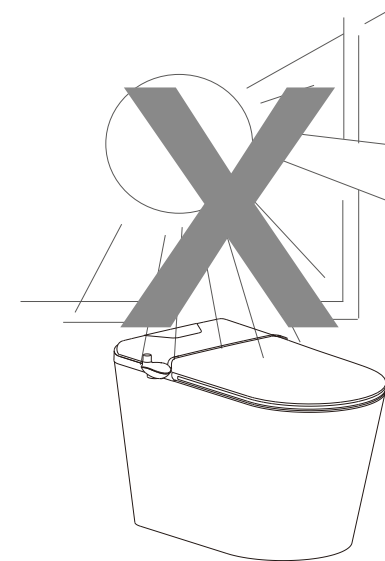

Using Notes

Wrong cleaning manners

Do not wipe the product with dry cloth or toilet paper.

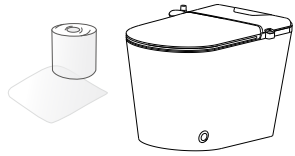

Flushing directly is forbidden

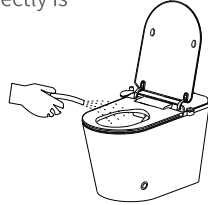

Routine maintenance

Do not urinate on the nozzle or product.

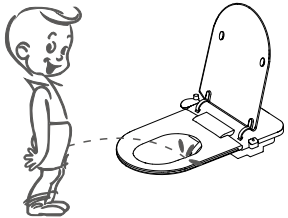

Pull out the electric plug when it is thundering.

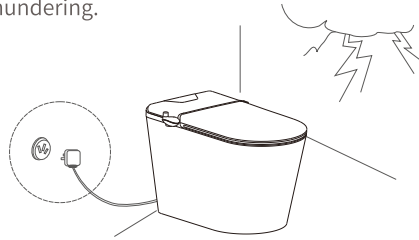

Attention of operation

Do not cover the sensor area, foot sensor, and the signal receiving and sending area of the remote control

Radio or similar products should stay away from the toilet.
• May cause much noise.

Do not lean your back on the cover

- May cause breakage.

Take the children cover away after children using the toilet fanly.

- Not doing so may cause some functions can not run.

Using Notes

Please prevent the freezing in winter to avoid damage.

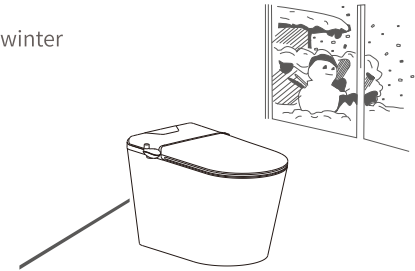

The heating apparatus should stay away from the product.

- Not doing so may cause discoloration or errors.

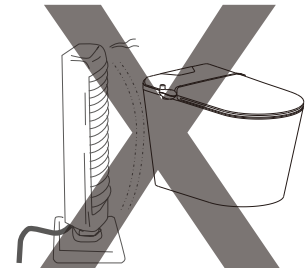

Please open the cover lid and cover seat gently.

- Not doing so may cause breakage or errors.

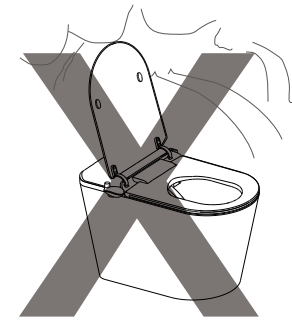

Name of Parts

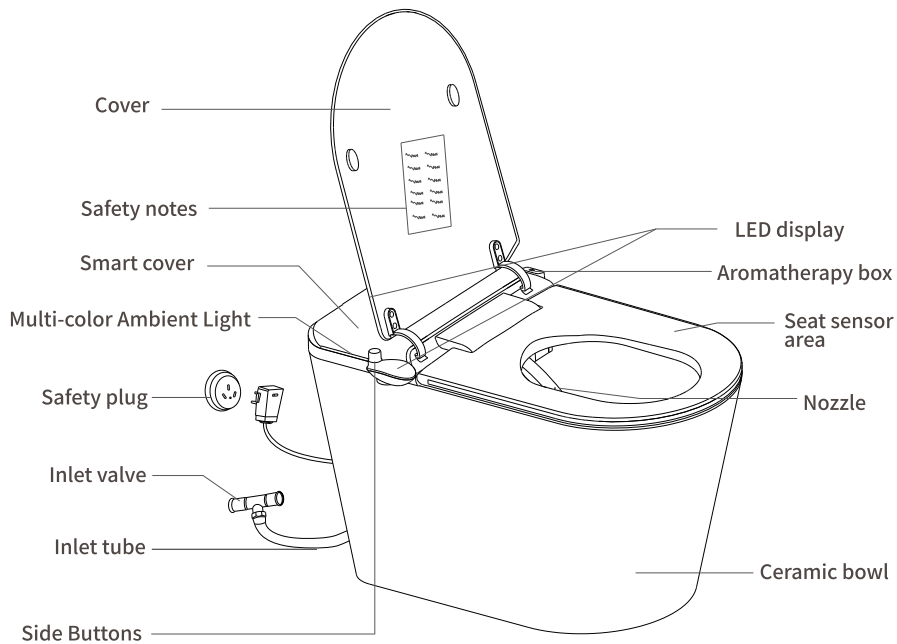

Knob Manual

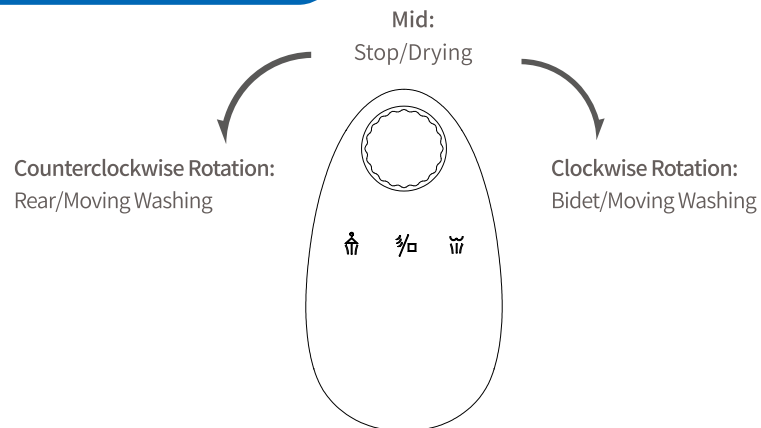

LED Display

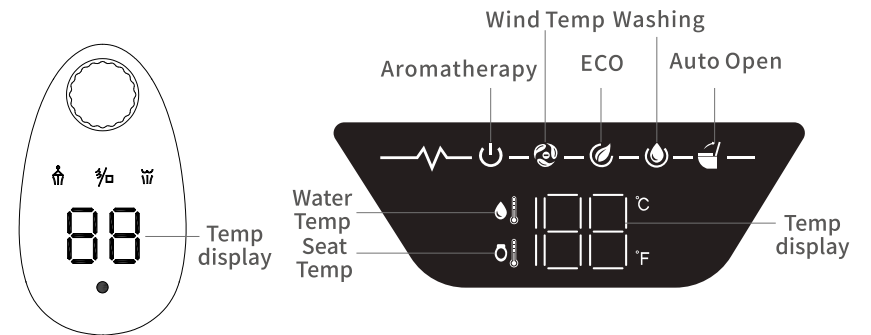

Noted: The small display displays the current temperature range state of the water temperature when the seat is on, and the seat temperature when the seat is not on.

Before Using

Please confirm things as below before using the product at first time.

Plug well

1. Plug in the Listed local voltage.

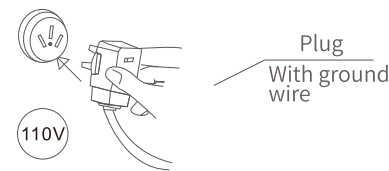

2. Please the inlet valve is opened or not.

Leakage Protected Plug

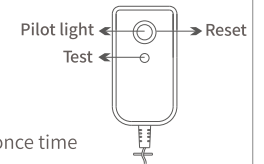

1. Please test once time each month
2. Press the "test" button
3. Confirm that the "pilot light" is off
4. Confirm that the product is out of work
5. Press the "reset" button to boot the product if every steps as above are OK.

Warning

- Please make sure the ground wire.
- Please contact electrical installation company if your socket is without ground wire.
- The original electric plug is for triple electrode type. (with ground wire)
- There will be changer of the electric shock while the product is out of work.
- Ensure the proper installation of water pipe, tube and valve, otherwise that would cause leakage and loss.

Before Using

Confirm each function

1. The nozzle, water pipe and tube.
2. The light of “saving mode” on LED display should be off while the seat sensor area is covered.
3. Check the rear & bidet washing, defecation assist, deodorization and drying function is well or not.
4. Check the damping is well or not.

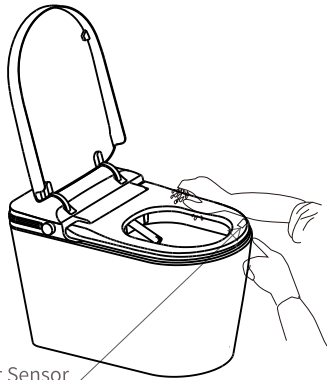

Confirm that the seat sensor is on working and the light of “saving mode” or the pilot light is off before checking the function of washing, drying and deodorization.

Caution

1. The washing function is for instant heating type. The function would be out of work if the water inlet is error.
2. Ensure the inlet valve is open and the inlet tube is not bent after the product is booted.

Warning

Only the listed voltage is accepted (AC 110V 60Hz). Please follow the relevant regulations for wiring.

* Will cause fire if ignore this warning *

Remote Control

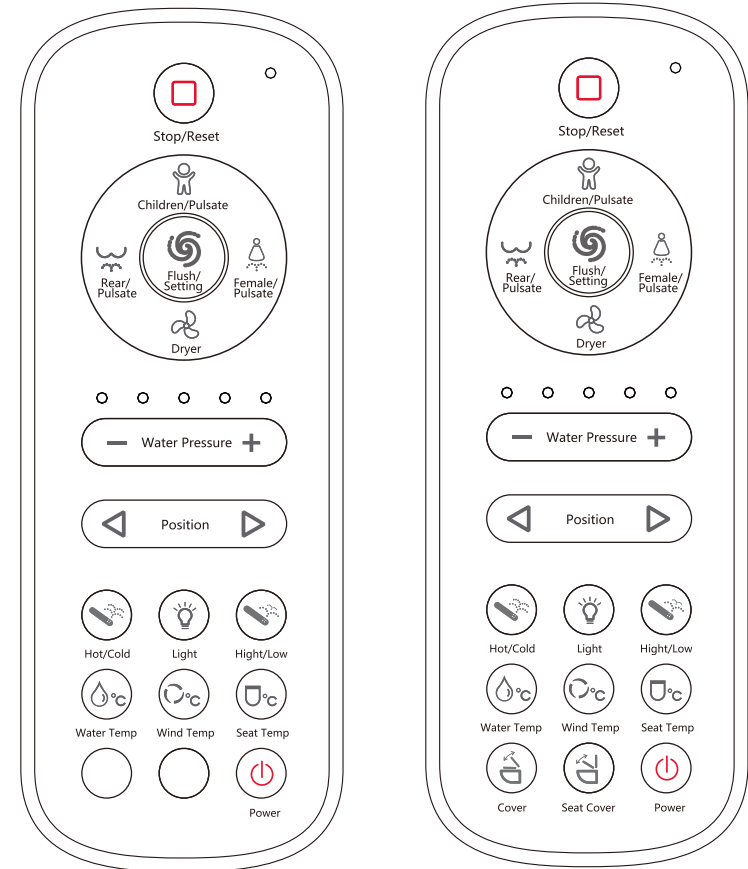

Pair the remote control to toilet

Step1: Unplug the power cord from the socket to cut off the power supply.









Step 2: Keep pressing the “bidet/female” key on the remote control until all indicating lights are flashing, then plug the the power cord of the smart toilet to the working socket, and wait until all lights are off to complete the pairing.

Please make sure there is sufficient power supply for the remote control before pairing. Cut off the power of the intelligent toilet for 30 seconds and then apply the above steps for pairing to remote control.

Operation

- ▶ **Power on/off**
Press the “Power”  button on the remote control to turn on the toilet, press the power button again to turn it off.
- ▶ **Seat Temp.**
Press the “Seat Temp.”  button to set the seat to a level of high, medium, low, or room temperature.
- ▶ **Water Temp.**
Press the “Water Temp.”  button to set the washing water to a level of high, medium, low, or room temperature.
- ▶ **Wind Temp.**
Press the “Wind Temp.”  button to set the dryer wind to a level of high, medium, low, or room temperature.
- ▶ **Rear washing**
Press the “Rear”  button to activate the washing via the nozzle, press again to activate moving washing. (Rear washing can only be activated when a user is sitting on the toilet.)
- ▶ **Bidet washing**
Press the “Bidet” 、 “Female”  button to activate the bidet washing, press again to activate moving washing. (Bidet washing can only be activated when a user is sitting on the toilet.)
- ▶ **Children**
Press the “Children”  button will automatically run washing-dryer-flush step by step with medium temperature, press the “Stop” button to stop immediately. (This function can be activated with or without a user is sitting on the toilet.)
- ▶ **Hot/Cold Massage**
Press the “Hot/Cold”  button to start with a switching high-low temperature of washing water. This can run simultaneously with rear washing or bidet washing.
- ▶ **High/Low Massage**
Press the “High/Low”  button to start with a switching high-low pressure of washing water while the rear or bidet washing is working.
- ▶ **Position**
Press the “Position”   button to adjust the nozzle forward or backward of moving washing while the rear, Children or bidet function is running. The nozzle will move forward and backward. Press the same button to stop moving.
- ▶ **Water Pressure Massage**
Press the “Water Pressure” +  - button to start with a switching high-low pressure of washing water while the rear or bidet washing is working.

Operation

- ▶ **Flush**
Press the “Flush”  button will start flushing for one time. When the toilet senses a user leaves after sitting on it for more than 10 sec, it will automatically flush one time. And after the rear washing or bidet washing finishes working with a seated status, the toilet will automatically flush one time.
- ▶ **Dryer**
Press the “Dryer”  button to start. Without manually stop, it will stop working after 3 mins.
- ▶ **Night lighting and ambient lighting**
Press the “Light”  button to turn on or turn off the night light and ambient lighting.
- ▶ **Stop/Reset**
Press the “Stop/Reset”  button to stop any running function like rear washing, dryer, etc.
- ▶ **Auto Open/Close (optional function, subject to model)**
The seat cover will open itself when people get close to the toilet, and the seat cover will close itself after 30 sec if a user stays near the toilet and leaves after 5 sec. When it is with an open seat and seat cover, if a user stays near the toilet and leaves within 5 sec, the seat cover will close itself after 120 sec. When it is with an open seat and seat cover, if a user stays near the toilet and leaves after more than 5 sec, the seat cover will close itself after 30 sec. When it is with an open seat and seat cover, if a user stays near the toilet and leaves within 5 sec, the seat cover will close itself after 120 sec and flush one time with closed seat and seat cover. (optional function, subject to model)
- ▶ **Open Cover (optional function, subject to model)**
Press the “Cover”  button to open the cover when it is closed. Press the “Cover” button  to close the cover when it is open. (This setting will not work with a seated status) (optional function, subject to model)
- ▶ **Open Seat Cover (optional function, subject to model)**
Press the “Seat Cover”  button to open the seat cover when it is closed. Press “Seat Cover”  button to close the seat cover when it is open. (This setting will not work with a seated status) (optional function, subject to model)
- ▶ **Foot sensor**
For model with an auto open seat cover, the cover seat will open itself while the foot sensor catches signal near the sensor area at the bottom right side. Perform the signal again to close seat cover.
For model without an auto open seat cover, the toilet will flush each time while the foot sensor catches signal near the sensor area at the bottom right side. (optional function, subject to model)

Operation

- ▣ **ECO (optional function, subject to model)**
 With an ECO feature, the seat temp. will be set to low level after the toilet is totally not used for more than 12 hrs, if the period extends to more than 48 hrs, the seat temp. will be set to deactivated.
- ▣ **UV Sterilization (optional function, subject to model)**
 The UV Sterilization will start after 3 sec when a user leaves a seated status for more than 60 sec and the cover is close.
- ▣ **To reduce the risk of burns**
 The seat temp. will automatically reach the low level with a seated status, and it will return to its set temp. when the toilet is not used.
- ▣ **Aromatherapy deodorization**
 Human contact seat induction area, aromatherapy automatically turn on 5S and automatically turn off, or long press the remote control "Hip washing button"5s Enable the aromatherapy deodorization function. Flavor addition can be proportioned with water according to preference.
- ▣ **Aambient Lighting**
 Don't seat down. When ambient lighting is working, press the left and right keys of the remote control "Position adjustment" to switch the atmosphere light mode: Off → Colorful Cycle → colorful water → White → Red → Blue → Green → Orange → purple → yellow → green → Off, cycle. Press "Night lighting"Key, switch on ambient light. Switch the buzzer to "ding ding ding" three times.

Featured Function

- ▣ **Microwave On-Off (optional, subject to model)**
 Simultaneously keep pressing the "Night Light" and "Water Pressure + or -" to adjust the microwave sensing distance from minimum 00 to maximum 05.
- ▣ **Auto Flush On-Off**
 Keep pressing the "High/Low" button to turn on/off the auto flush after the seat is not taken. A sound of 2 times indicating off while a sound of 1 time indicating on.
- ▣ **Soft-shutdown**
 Keep pressing the "Stop" on the side buttons to switch soft shutdown.

⚠ **Attention:** A user can't use dyer and washing function while the seat is not taken.

Using Notes

Water Temp.

Capacity

Instant heating device ensure the

Water temp. base on levlle setting

Normal: No heating
 Low : About 93°F
 Mid : About 99°F
 High : About 104°F

The effect of heating dependson the water temp.

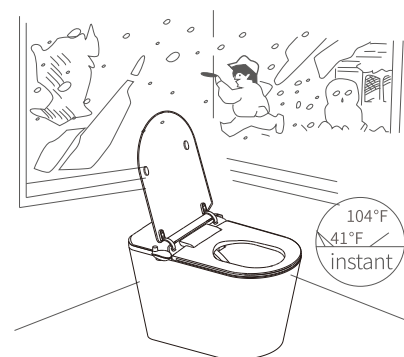

Seat Sensor

The washing functions would not run by operation in error

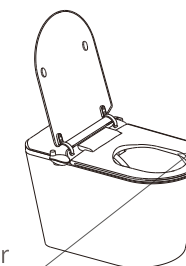

Seat Sensor

The seat sensor would not work if:
 ※ No people the seat sensor area.

Using Notes

Energy Saving(ECO)

Would save energy as below

- Close the cover after using
- Do not set the high level for temp. every time
- Set the suitable temp. on seasons and air temperature
- Use the energy saving as much as possible
- The power if the product will not in use for a long time
- ※ Prevent the freezing

Close Cover Softly

The soft-close device would avoid the noise of cover colsing

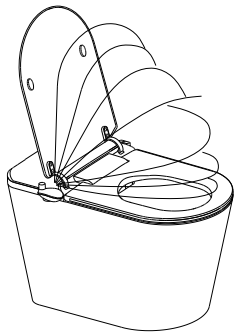

Water flow out ?

That would be normal that some water flow of the nozzle before/after washing or while the water temp. setting is on.

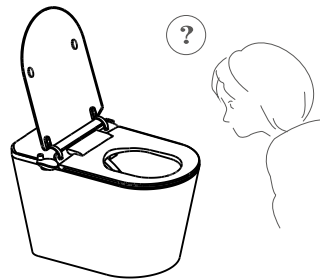

Please close the inlet valve and pull out the plug if the water keep flowing out besides the situations as above. And you need to contact the agency.

Maintenance

⚠ Warning

Make sare to unplug pull out the electric plug and confirm the pilot light is off before maintenance.

Maintenance of Smart Toielt

Please use soft cloth with clean water

- Please wipe the product often with wet soft cloth in case of the dirt is too hard to clean out. In addition, the wet soft cloth can avoid the static to adsorb dust and cause the product dirty.

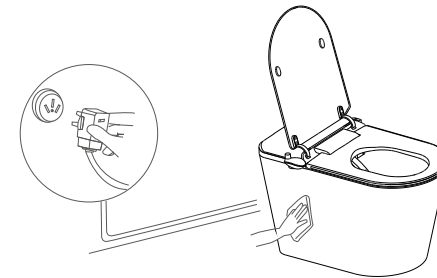

Maintenance of Nozzle

Please clean the nozzle with soft brush.

- ※ Turn the knob key until the nozzle is out after leaving the cover seat.
- ※ Do not pull out and bend the nozzle by force.

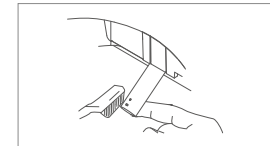

⚠ Warning

- ⚠ Please clean the dust on the electric plug. Clean the plug with dry cloth after pull it out of socket.
- Must follow ※ Poor insulation may cause fire.

Installation

INSTALLATION DRAWING PLAN & Names of Parts

As shown in Picture No.1, be the major component and construction points
Length Unit : mm

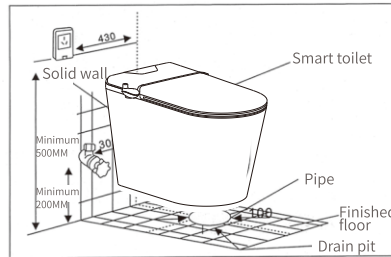

Fig1

Before Installation

Required tools may include Adjustable Spanner, levelling instrument, cross screwdriver, glass cement, slotted screwdriver, measuring tape, knife, etc.

Installation Procedure

Please mark the center line of the drain outlet on the ground, then according to the size of the toilet, install the water inlet angle valve on the suitable point of the wall.

- ✘ Please install the water inlet angle valve as Picture No. shown.
- ✘ Construction installation Instructions please find the following Pictures NO.2,3 and 4

A Please make sure the wall is aligned with the center line of the drain outlet (there are two pit distance options, 305mm and 400mm)

B Please mark the location of the center hole (Use the right installed holes based on the real situation)

C Please roll over the toilet gently, make its side with accessory and seal ring be press firmly to the drain outlet of the toilet bottom.

D Please make sure the toilet drain outlet is aligned with vertical position of the outfall

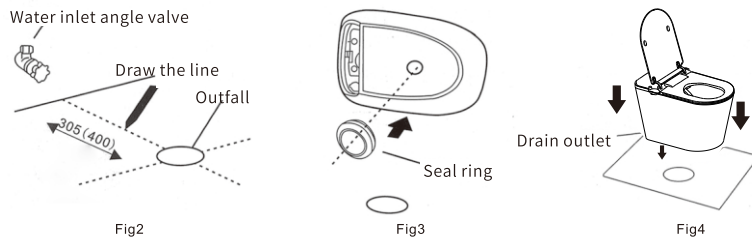

Fig2

Fig3

Fig4

✘ Toilet Installation



Tips: Concerned the weight of the toilet, suggested two people hold together and please keep the seat cover and seat ring be opened before that.

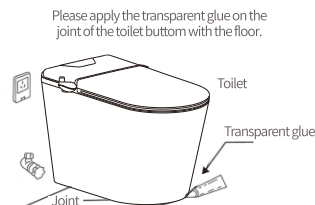

Please apply the transparent glue on the joint of the toilet bottom with the floor.

Toilet

Transparent glue

Joint

Installation

Tips 1

1. Please make sure the pipes be cleaned, then go to the installation. Because the hose has just been renovated and may left less mud and sand, very easy to damage the toilet and bring something bad towards human's body.
2. Please ask the professional fixed workers to do this job, and make sure carefully every part is correct when done. Kindly please use it after 48 hours when the gule be set.

Tips 2

After Connecting the water pipe and turn on the angle vane, if the nozzle have the situation of water penetration, please be plugged in, it will automatic reset and stop water penetration. Please turn off the power supplies and the water when you are going to take it apart.

1. During the using and cleaning, if power cut happened, please do not touch the nozzle. When the power on, the function will be back normal by self-test.
2. Please use the supplied special Water inlet angle valve and the related accessory strictly.

Cleanning the angle valve.

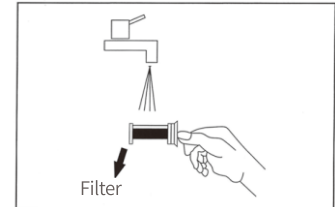
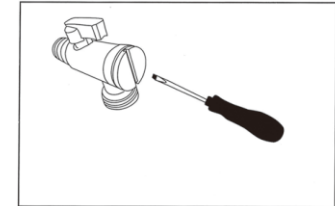

Turn off the angle valve, open the back side by flat screwdriver or coin tool, then remove the filter and cleaning

⚠ Warning

1. It is strictly prohibited to disassemble or disassemble privately because the accessory of intelligent toilet was turn up well when you buy it.
2. All content of this operating manual, are based on the latest situation of the product at the time of printing, the company reserves the right to change, No Further notice will be given.

1. Must pull out the plug
May cause electric shock if not to do
May cause the fittings damage by water if not to do
3. Do not extrud the wire and tube
May cause electric shock or leakage
4. Handle with care while dismantling the cover to clean
May cause leakage and error
5. Do not put the cover upside down and put on the ground without pulling out the plug
May cause damage of surface and error
6. Before removing the toilet cover, be sure to completely empty the storage liquid in the aromatherapy box with polyester cotton. Otherwise, the storage liquid will leak into the base and a fault will occur.

Do not put the cover upside down.
Do not put the cover on the ground.



Not in use long term

Must clean up the water for situations as below

- The product will be not in use for a long time that would cause blockage by polluted water
- The water will be frozen and leakage cause by falling temperature in uninhabited house

Caution

Must the inlet valve before dismantling any inlet tube

Ensure correct installation of inlet tube

※ May cause leakage easily



Replacing Battery

The pilot light will be getting light or off and the signal can not be transmitted when the battery is almost done.

- ※ The service life of battery we supply will be very shot cause it is mainly for checking conditions of running in the installation.
- Ensure the position of positive pole and negative pole is correct
- The new and old batteries can not be mixed together
- Please use alkaline battery

Replacing battery of remote control

Open the back cover of remote control and replace two 1.5v AAA alkaline battery

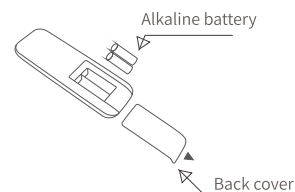

Freezing Damage

The smart toilet will be damage and leakage cause by freezing water from toilet in winter.

Please follow the instructions as below to avoid it.

General Measures

1. Keep power on

2. Set the water temp. and seat temp. to high level and close the cover

3. Turn on the heating in house

- Please follow the ways as below to clean up the water from inlet tube if there is not heating.
- a. Close the inlet valve
- b. Run the rear washing until there is no water out after setting to normal level and put a hand on the seat sensor area.

No water out cause freezing

Please use the hot cloth cover on the inlet valve or connecting parts until the water is unfrozen when the water is frozen.

Caution

Do not put the hot water on the tube and do not blow hot air on it.

※ May cause damage of tube

Caution

Must close the inlet valve before dismantling inlet tube.

Ensure correct installation of inlet tube.

※ May cause leakage easily



Error Recognition

There are some simple can be fixed easily.

Please confirm matters below before sending the product to a maintenance center.

Error	Reason	Method
No water out	power of socket is off	check if power failure
	power of product is off	press “start” button to boot the toilet
	no plug in socket	plug in socket well
	leakage of electric	pull out the plug and send the product to maintenance center
	inlet valve is closed	open the inlet valve
	the fillter is dirty	clean the fillter
	inlet tube is blocked	clean up the tube
	out of seat sensor area	adjust the seating position
	the nozzle is blocked	clean the nozzle
	low water pressure	increase water pressure
Water not warm	water pipe or tube is frozen	Please use the hot cloth cover on the inlet valve or connecting parts until the water is unfrozen
	not set the proper water temp. yet	presse water temp. button and set a proper level
Cover not warm	temp. of inlet water is too low	run washing for a while and check after a period of time
	not set the proper seat temp. yet	presse seat temp. button and set a proper level
Smell not well	blocked by dust	clean the part of deodorization

Please contact for a service if the faults still can not be fixed.

Specifications

Part		Spec.	
Rated voltage		AC110V 60Hz	
Power		1200W	
Washing functions	Water flow	Rear	400-620 ml/min
		Bidet	450-640 ml/min
	Outlet temp.	home temp./93°F/99°F/104°F(4 levles)	
	Pressure	4 levles	
	Heating power	1400W (max)	
Safety device		Leakage protector,Water temperature sensor,Thermal fuse	
Drying	Wind temp.	home temp./113°F/122°F/131°F(4 levles)	
	Heating power	250W	
	Safety device	sensitive switch, temp. fuse	
Seat heating	Seat temp.	home temp./93°F/99°F/104°F(4 levles)	
	Heating power	45W	
	Safety device	sensitive switch, temp. fuse	
Massage		strong and weak spaced vortex bubbles	
Nozzle position		adjustable for forward and backward	
Inlet water temp.		41°F~104°F	
Inlet pressure		1.5–7.5khf/cm ² (0.1.5 –0.75Mpa)	
Carton size		760mmx450mmx520mm	
G.W		≈50.5kg	