

>>assembly instructions

Congratulations on your latest purchase.

Now what? Don't start sweating over this box of parts. This will be easy. We did the hard work for you. All you need to do is follow our simple instructions and you'll be on your way to transforming your room in no time. Good luck --though we're confident you won't need it.

before you begin

1. Check for damaged or missing parts.
2. Use the carton as a working surface to prevent product damage during assembly.
3. Gather all tools prior to assembly.

table of contents



introduction	2
hardware	4
parts list	5
assembly	6-7

hardware

(A) x 8

5/16" x 45mm
round hex screw

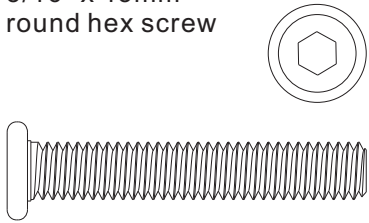

(B) x 8

Φ 8mm lock washer



(C) x 8

Φ 22mm flat washer

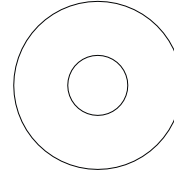

(D) x 1

5mm Ball end
Hex wrench



ITEM DESCRIPTION QUANTITY



①	seat	1
②	armrest	2

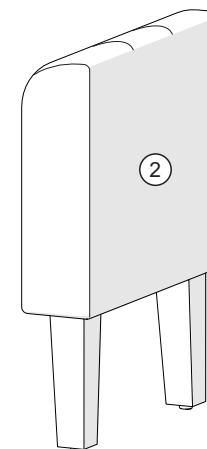
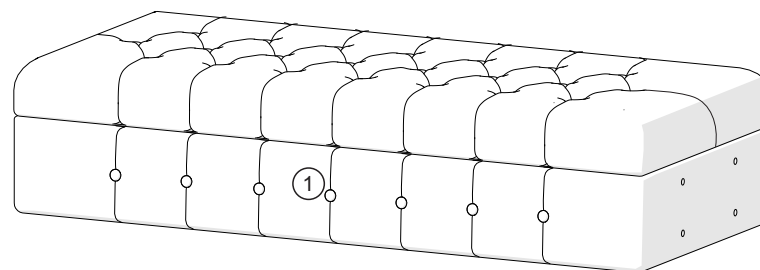
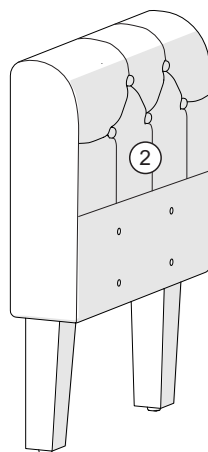

step 1.

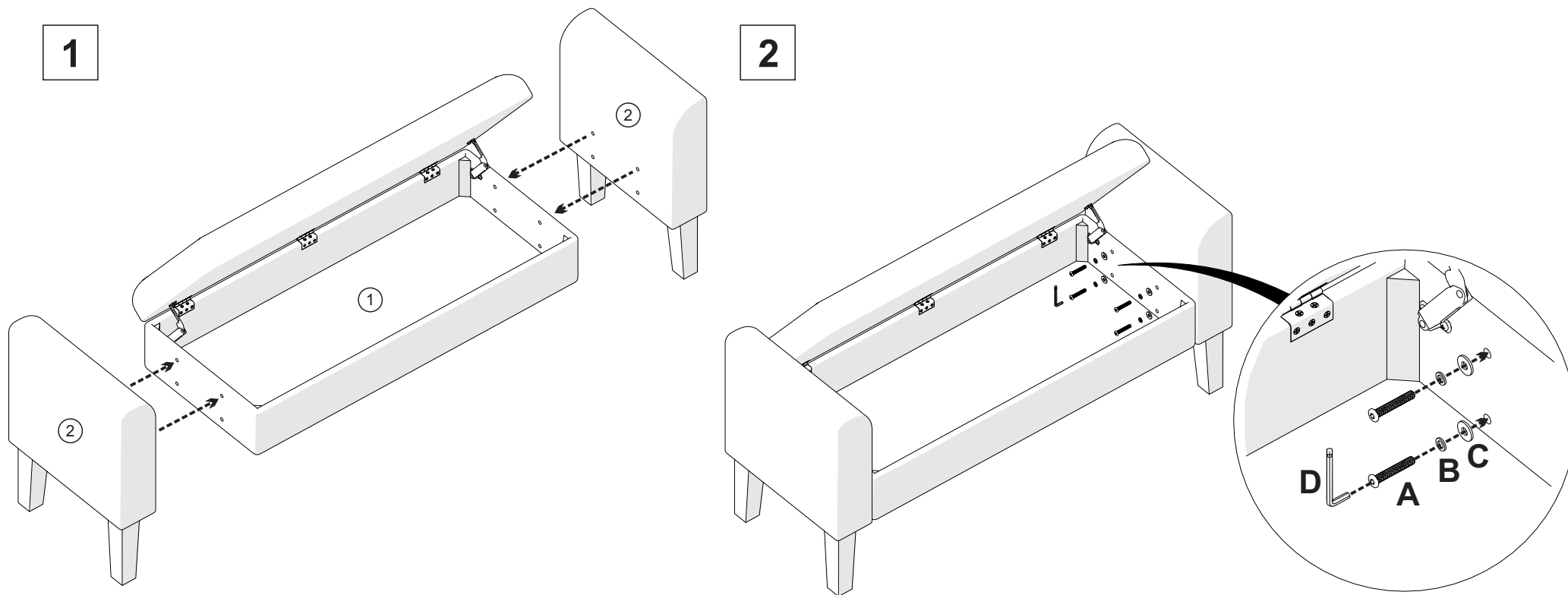

(A) x 8

5/16" x 45mm
round hex screw

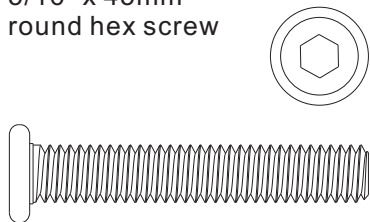

(B) x 8

Φ 8mm lock washer

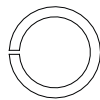

(C) x 8

Φ 22mm flat washer

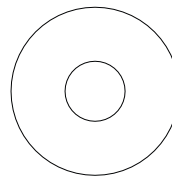

(D) x 1

5mm Ball end
Hex wrench



Please do not assemble with power tools

step 2.

A friendly reminder from us:

Please keep the Allen wrench.

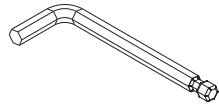

After a period of time, there may be a chance the KD furniture may become loose, please use an Allen wrench to tighten the loose bolts.

Put the chair right and check whether the chair has been well assembled. If it is not assembled, loosen the screw and tighten it on the ground.

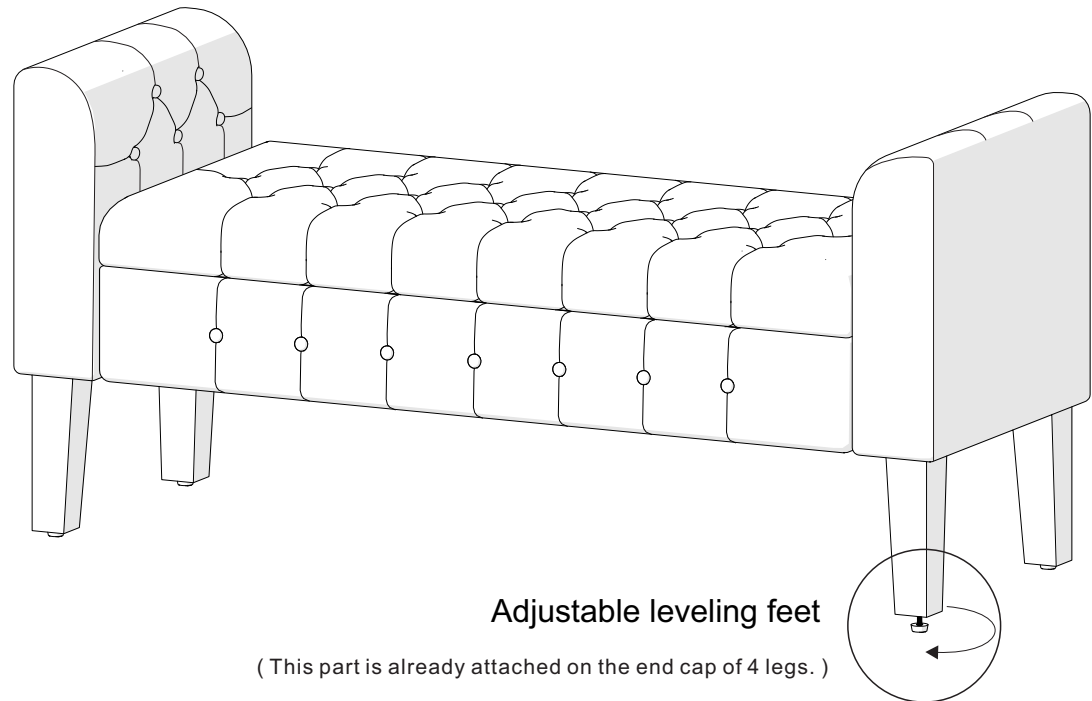

Level the furniture, use leveling feet if needed.