

Products / Dining Tables / Quartz Dining Table 69x69

Quartz dining table 69x69

by Ramón Esteve

The Quartz chairs and table collection, designed by Ramón Esteve for Vondom, is characterized by its **orthogonal geometry and triangular shaped profiles**. Due to the line of one of its vertexes this piece appears extremely light.



Info

Description

Made of gas air moulding injected polyamide with fiber glass for legs and HPL table tops. Stackable. Available in 3 colors. Item suitable for indoor and outdoor use.

Weight: 8.51 Kg

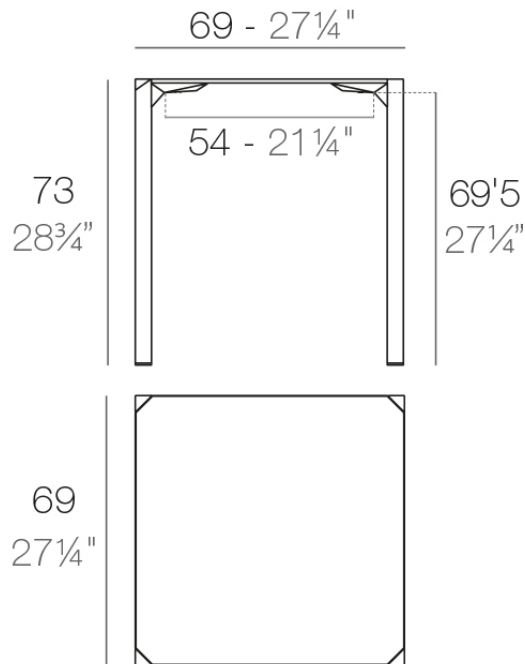

QUARTZ Mesa 69 x 69
QUARTZ Table 27 1/4" x 27 1/4"

Finishes

finishes

BASIC PP
Ref. 54204



white



black



ecru

Available in various colors

