

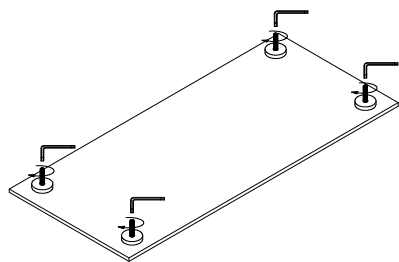

1

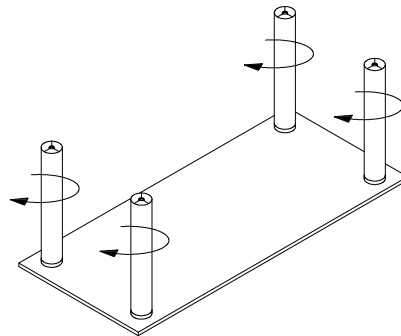

<b>1</b>	Top Glass		x1
<b>B</b>	Bolt#2		x4



2



<b>4</b>	Tube#2		x4
----------	--------	---	----

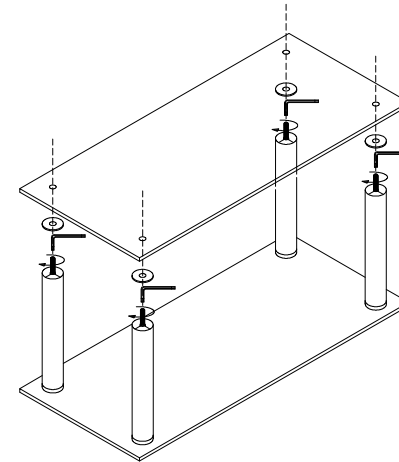

3

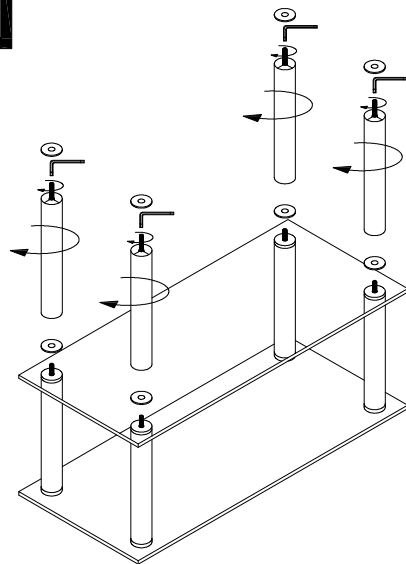

<b>2</b>	M/B Glass		x1
<b>A</b>	Bolt#1		x4
<b>C</b>	Plastic Spacer#1		x4

4



<b>3</b>	Tube#1		x4
<b>A</b>	Bolt#1		x4
<b>D</b>	Plastic Spacer#2		x8

5

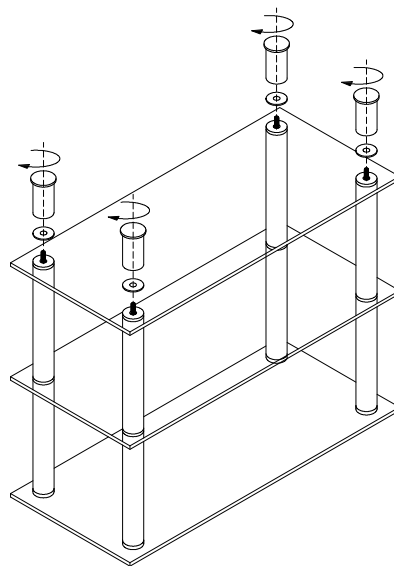

<b>5</b>	Foot Tube		x4
<b>C</b>	Plastic Spacer#1		x4

6

