

ALTECK

ECLIPSE

Wall Sconce

AW0091-3CCT-W

DIMENSIONS

Height: 24 3/4"

Width/Diameter: 24"

Depth: 3 3/4"

Minimum Height:

Maximum Height:

Canopy/Backplate: 16"x16"

Product Weight: 15 lb

SPECIFICATIONS

Location Listed: Wet

IP Rating: IP44

Rated Life: 54000 Hours

Standards: ETL, cETL, ADA

Input: 120~277 VAC, 50/60Hz

TRIAC Dimming: 100-10%

Mounting: Wall Mount

Color Temperature: Adjustable

3000K/4000K/5000K

CRI Rating: 80

Material: Aluminum

Diffuser Material: Frosted acrylic

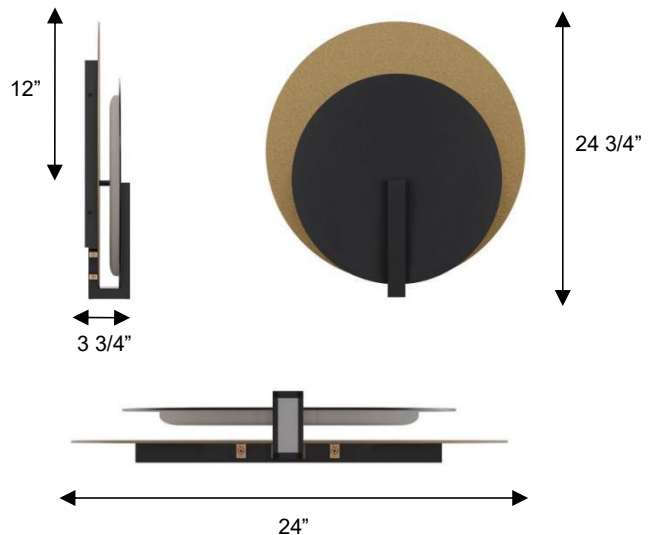

AVAILABLE FINISHES



ORDERING INFORMATION

AW0091-3CCT-W	COLOR TEMP	FINISH	VOLTAGE	WATTS	DELIVERED LUMENS
	3000K/4000K/5000K	BK/PB BLACK/PAINTED BRASS	120~277V	22W	680

Example: AW0091-3CCT-W-BK/PB

For customer requests please contact: info@altecklighting.com

altecklighting.com