





## CONTACT US

⚠ Note: After opening the package, Please inspect the product immediately for damage in transit or missing parts. If there is any missing, Please contact us

### 1. Installation Guide Without Service Parts

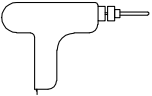
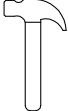
Goggles, Marker, Ruler, Level, Screwer, Hammer

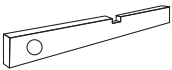
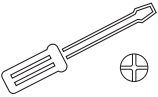
Power Drill with 15/64" (6mm) drill bit

|   |   |   |   |
|---|---|---|---|
| <br>Electric Drill | <br>Hammer               | <br>marker pen   | <br>Safety Goggles |
| <br>Level          | <br>Phillips Screwdriver | <br>Tape Measure |   |

2. Measure distance between frame and hook (A, B)

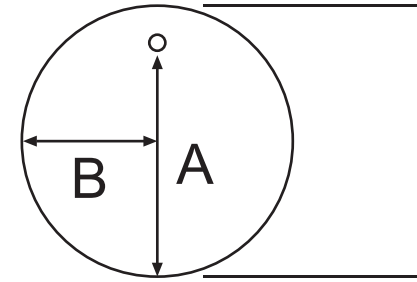

3. C 3" (76 mm) required clearance and mark the hole position (a)(b)(c)

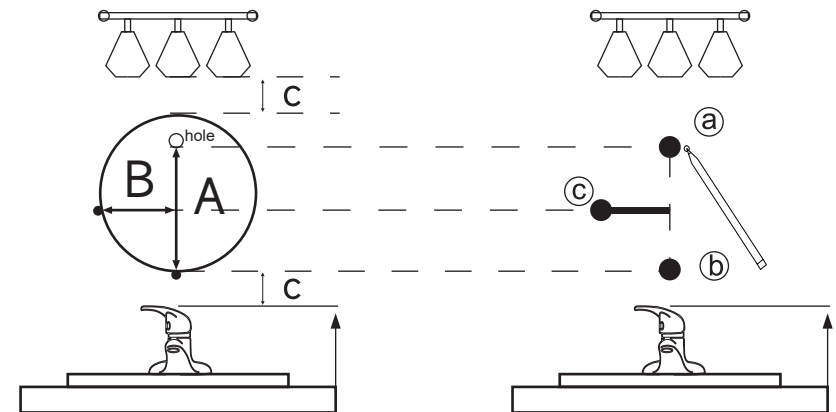

4. Drill 15/64" (6mm) a hole of 1.8" (45mm) depth, and hammer the anchor into wall

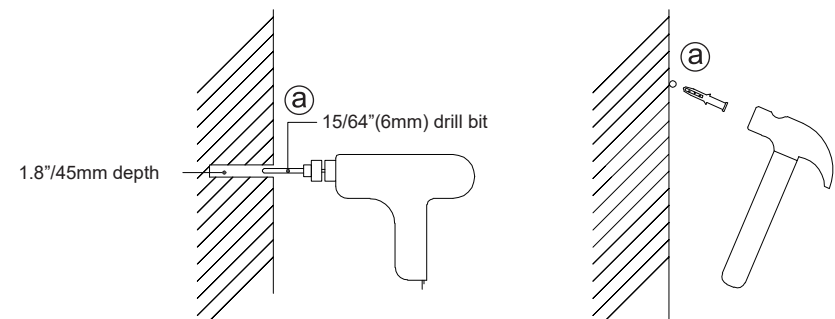

5. Tighten the screw on the wall anchor, set aside 0.5" (12mm)

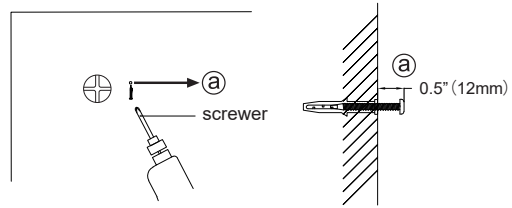

6. Hang the mirror over the point b (please confirm the hook is hanging on the screw safely when viewed from the side)

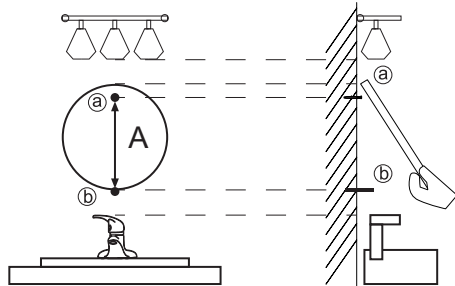

7. Take off the paper of **Hook-and-loop fastener** on the backboard, and make it stick to the wall tightly (Stick it or not is optional)

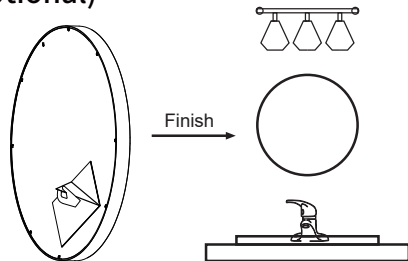

Accessories: 2pcs screws and 2pcs anchors



## Metal Wall Mirror

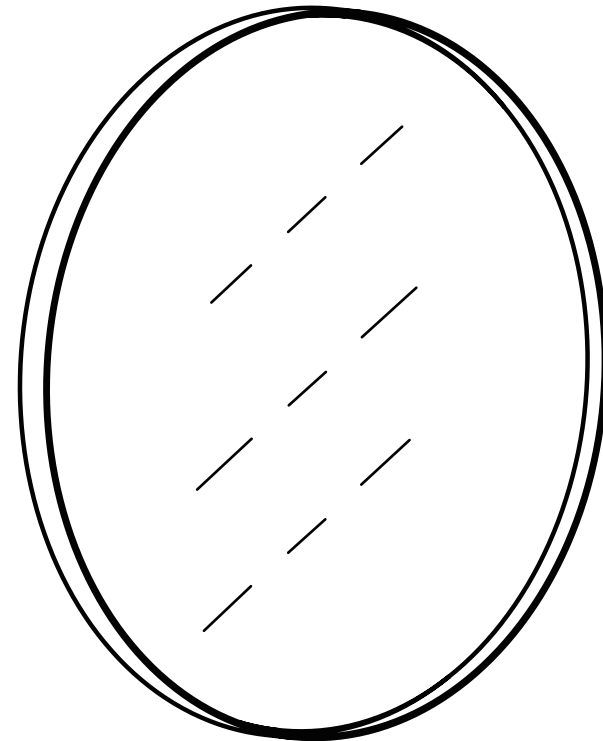

## Installation Instruction

If you have any problem, please feel free to contact us