

Assembly instructions for the ottoman:

- Tools:** A screwdriver is shown as the required tool. A power drill is shown with a diagonal line through it, indicating it is not to be used.
- Warning:** A triangle with an exclamation mark indicates a warning.
- Time:** A clock icon is shown above the number "15'", indicating an estimated assembly time of 15 minutes.
- Personnel:** A person icon is shown above the number "2", indicating that two people are required for assembly.

A

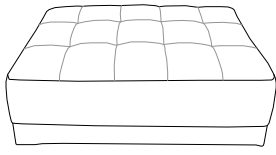

x 1

B

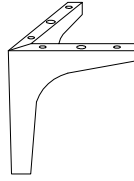

x 4

C

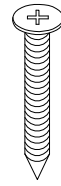

**5
x
25**

x 16

A

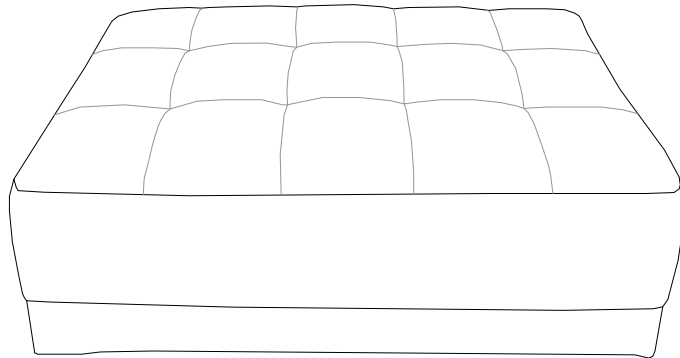

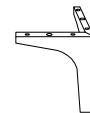
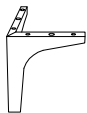

B x 4

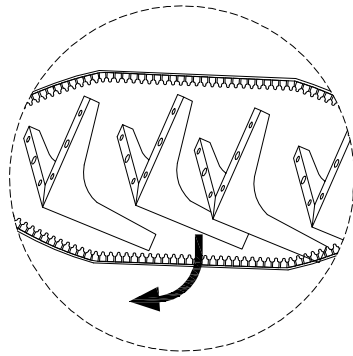
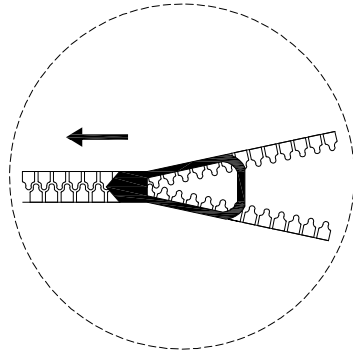
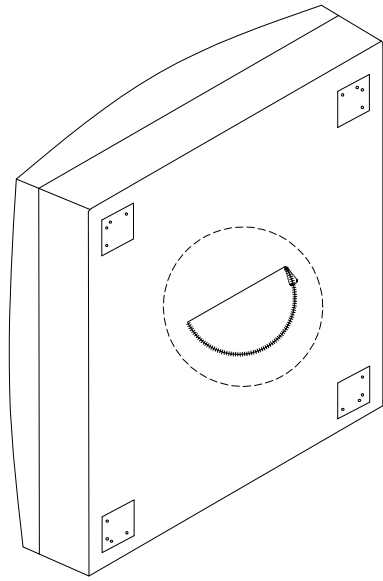

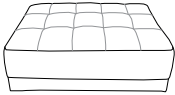
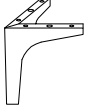

1

<p>A</p>  <p>x 1</p>	<p>B</p>  <p>x 4</p>	<p>C</p>  <p>5 x 25</p> <p>x 16</p>
--	--	---

