











Installation Instructions

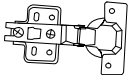
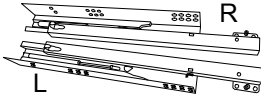

Some important notes before beginning assembly:

- Count all parts and hardware to make sure that there are no pieces missing.
- If a power drill or screwdriver is used, set the tool on low power setting. Reclaimed woods are generally a bit delicate, and using a power tool with too much power or speed may damage the wood.
- When assembling the cabinet, do not tighten the bolts until all cabinet pieces are put together. Keeping the bolts loose will greatly help with adjustments and preventing damage. Tighten the bolts after every piece is in place.
- Each cabinet panel will have a sticker to indicate which side is the front. Follow these stickers to make sure the pieces are not assembled backwards.

Hardware List

| | | | |
|-----|----------------------|-------|---|
| N1 | Long Bolt | 20pcs |  |
| N2 | Tension Washer | 8pcs |  |
| N3 | Washer | 8pcs |  |
| N4 | Allen Wrench | 1pc |  |
| N5 | Drawer/Door Pull | 11pcs |  |
| N6 | Door Hinge | 4pcs |  |
| N7 | Drawer Glides | 8pcs |  |
| N8 | Short Bolt | 20pcs |  |
| N9 | Long Wood Screw | 32pcs |  |
| N10 | Short Wood Screw | 88pcs |  |
| N11 | Long Hardware Screw | 4pcs |  |
| N12 | Short Hardware Screw | 18pcs |  |

Step 1-Cabinet Assembly

Parts Required: Panel A1,Panel B,N1(2PCS),N2(2PCS),N3(2PCS)

- Lay panel A1 down with the Front sticker facing up
- Attach panel B to A1 according to diagram
- Hand fasten bolts, do not tighten



Installation sequence of N2 and N3



Step 2-Cabinet Assembly (Continued)

Parts Required: Panel A2,Panel B,N1(2PCS),N2(2PCS),N3(2PCS)

- Attach panel A2 according to diagram
- Hand fasten bolts, do not tighten

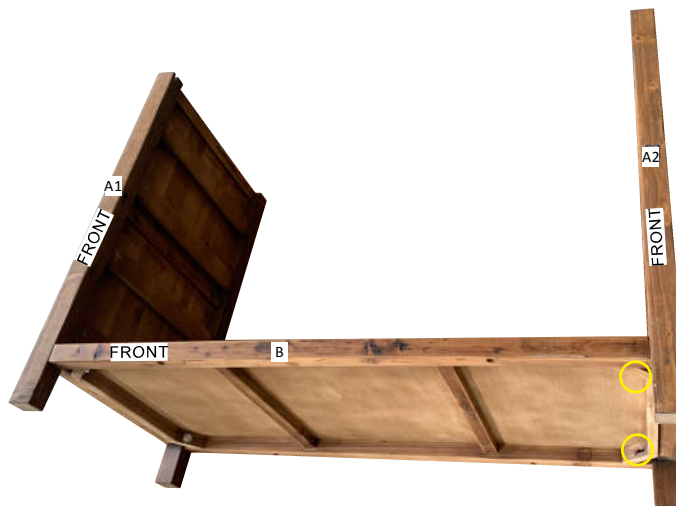

Step 3-Cabinet Assembly(Continued)

Parts Required: Panel E (2pcs)

- Attach panel E according to diagram



Step 4-Cabinet Assembly (Continued)

Parts Required: Panel D1,N1 (4pcs)

- Attach panel D1 according to diagram
- Secure with N1 bolts. Do not overtighten

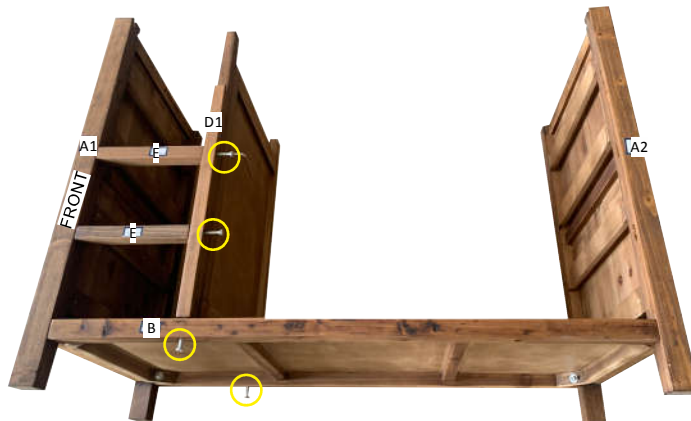

Step 5-Cabinet Assembly(Continued)

Parts Required: Panel E (2pcs)

- Attach panel E according to diagram



Step 6-Cabinet Assembly (Continued)

Parts Required: Panel D2,N1 (4pcs)

- Attach panel D2 according to diagram
- Secure with N1 bolts. Do not overtighten

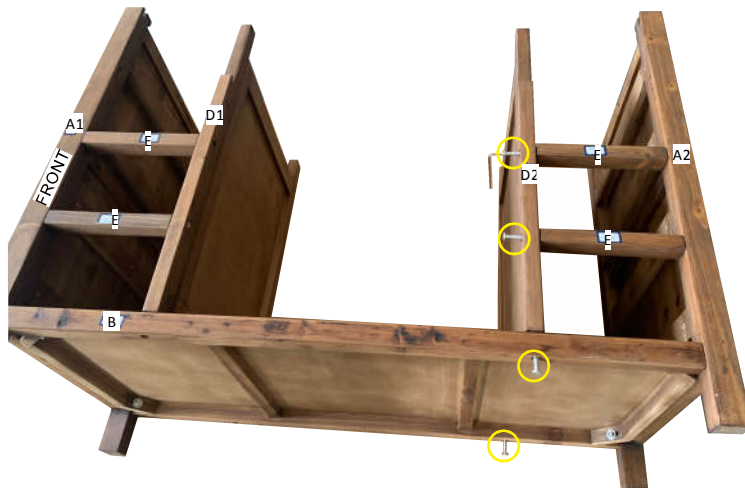

Step 7-Cabinet Assembly(Continued)

Parts Required: Panel C

- Stand up the cabinet, place panel C according to diagramplace

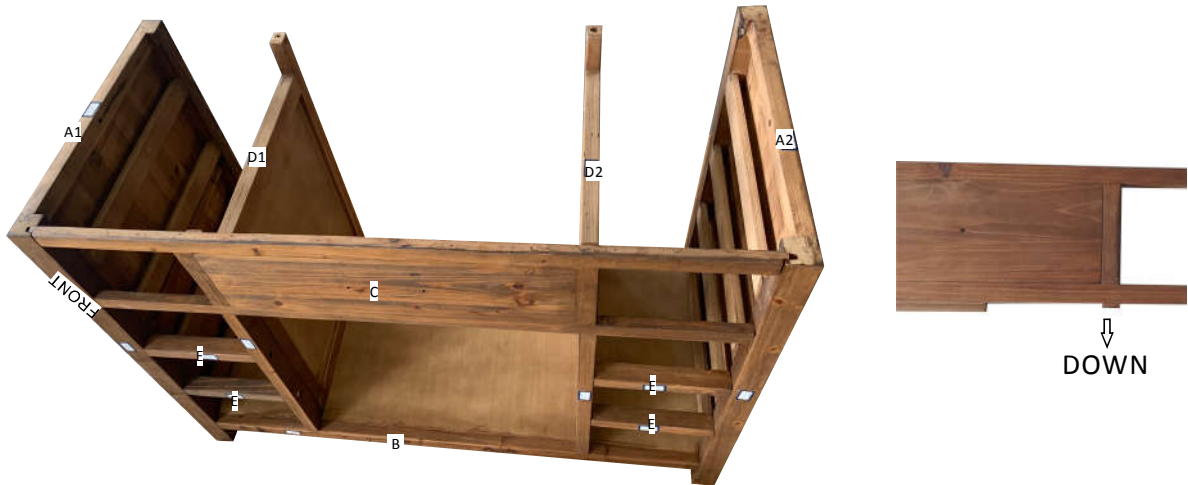

Step 8-Cabinet Assembly (Continued)

Parts Required: Panel F

- Place panel F as shown on diagram. Watch for “Front” and “UP” indicators for proper placement



Step 9-Cabinet Assembly(Continued)

Parts Required: N1 (8pcs), N2 (4pcs), N3 (4pcs)

- Hand fasten the side bolts (N1+N2+N3). Do not tighten
- Secure bolts (N1) according to diagram. Do not overtighten



Step 10-Cabinet Assembly ,Adjustment

Parts Required: N8 (4pcs)

- Fasten N8 bolts as shown on diagram. Do not overtighten
- Carefully tighten N1 bolts on the 4 corners. Notice that tightening the bolts will adjust the positioning of panel F. Work all 4 corners until the panel sits straight
- Once Panel F is adjusted correctly, tighten the other 4 N1 bolts underneath the cabinet. Adjust carefully and do not overtighten



Step 11-Drawer Assembly (8 drawers)

Parts Required: Panel J (8pcs), Panel I (8pcs), N5 (8pcs), N8 (16pcs), N12 (16pcs)

- Attach N5 to panel I using N12 (2 per handle). Tighten
- Attach Panel I to Panel J using N8 (2 per drawer). Do not overtighten

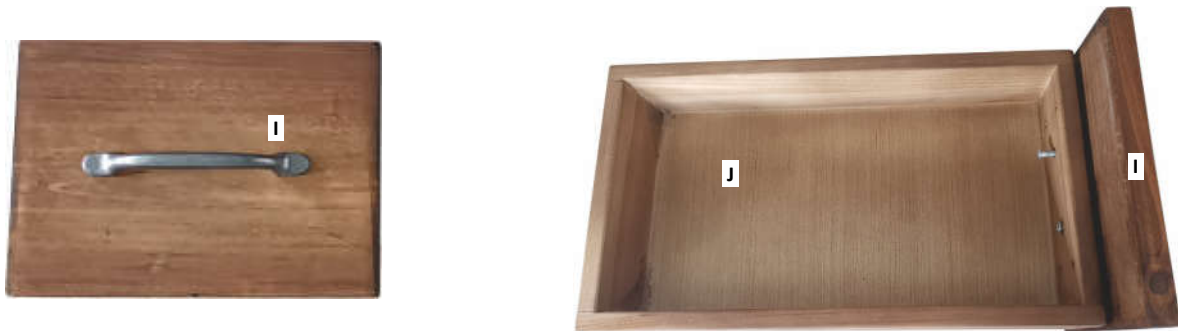

Step 12– Installing Drawer Glides (Left Side of Cabinet,4 sets)

Parts Required: N7 (4prs), N10 (16pcs)

- Each pair of N7 has a left and right side. Make sure that they are installed on the correct side
- Locate the small indentations inside the cabinet. Those indentations will be where the N10 screws will be drilled into
- Place the N10 screws (2 per glide) on the outer top holes of the glides as indicated on the diagram and screw into the indentations for all 4 sets. Tighten screws so that the glides are secured to the cabinet

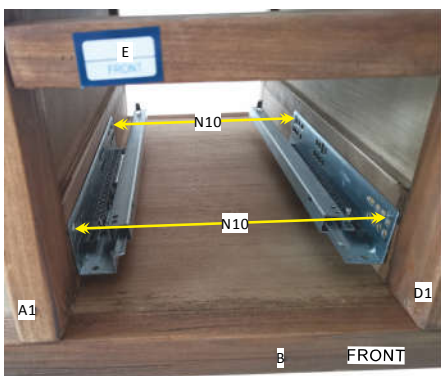

Step 13-Installing Drawers

Parts Required: N10 (8pcs, 2 per drawer)

- Locate the hooks on the back of the glides, hook into the holes on the back of the drawers as shown in diagram
- Locate the height adjustment poles on the glides and insert into the hole on the bottom of drawer as shown in diagram
- Carefully screw in N10 as shown in diagram. Do not overtighten as adjustment may need to be done



Step 14-Adjusting Drawers

Parts Required: Screwdriver

- If any of the drawers are not sitting correctly, they can be adjusted by either repositioning the drawer glides or adjusting the height adjustment poles as shown in the diagrams

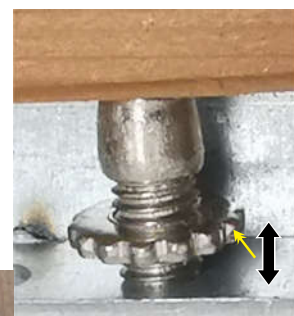

Step 15-Secure Drawer Glides and Drawer Panels

Parts Required: N10 (8pcs), N9 (16pcs)

- Once the drawers are properly adjusted, secure each glide with 1 additional N10 screw in one of the middle holes as shown in diagram
- Secure each drawer panel I with 4 N9 screws as shown in diagram



Step 16- Installation of Right-Side Drawers

- Follow steps 12-15 for installation of right-side drawers



Step 17-Prepare Doors H1 and H2 for Installation

Parts Required: N5 (2pcs), N6 (4pcs), N11 (4pcs), N10 (8pcs)

- Attach N6 hinges to doors as shown in diagram. 2 N10 screws per hinge
- Attach N5 handles to doors using N11 bolts



Step 18-Installation of Doors

Parts Required: N10 (4pcs)

- Locate the indentations in the cabinet where the hinges should attach to. Use these indentations to drill and secure the door hinges by the large holes found on the hinges using N10 screws (1 N10 per hinge)
- Do not overtighten the screws to allow adjustments found on the next step



Step 19-Door Adjustment

Parts Required: N10 (12pcs)

- The doors can be adjusted left/right or in/out by adjusting the screw on each hinge as shown on the diagram
- Once adjustments are done, use N10 screws (3 per hinge) to properly secure the hinges to the cabinet. Tighten all screws



Adjust height



Adjust laterally



Adjust depth

Step 20-Handle Installation

Parts Required: Panel N5 (1pc), N12 (2pcs)

- Use 2 N12 screws to secure N5 handle to panel C

