

# 3 Seater Sofa

---

## Operating instruction

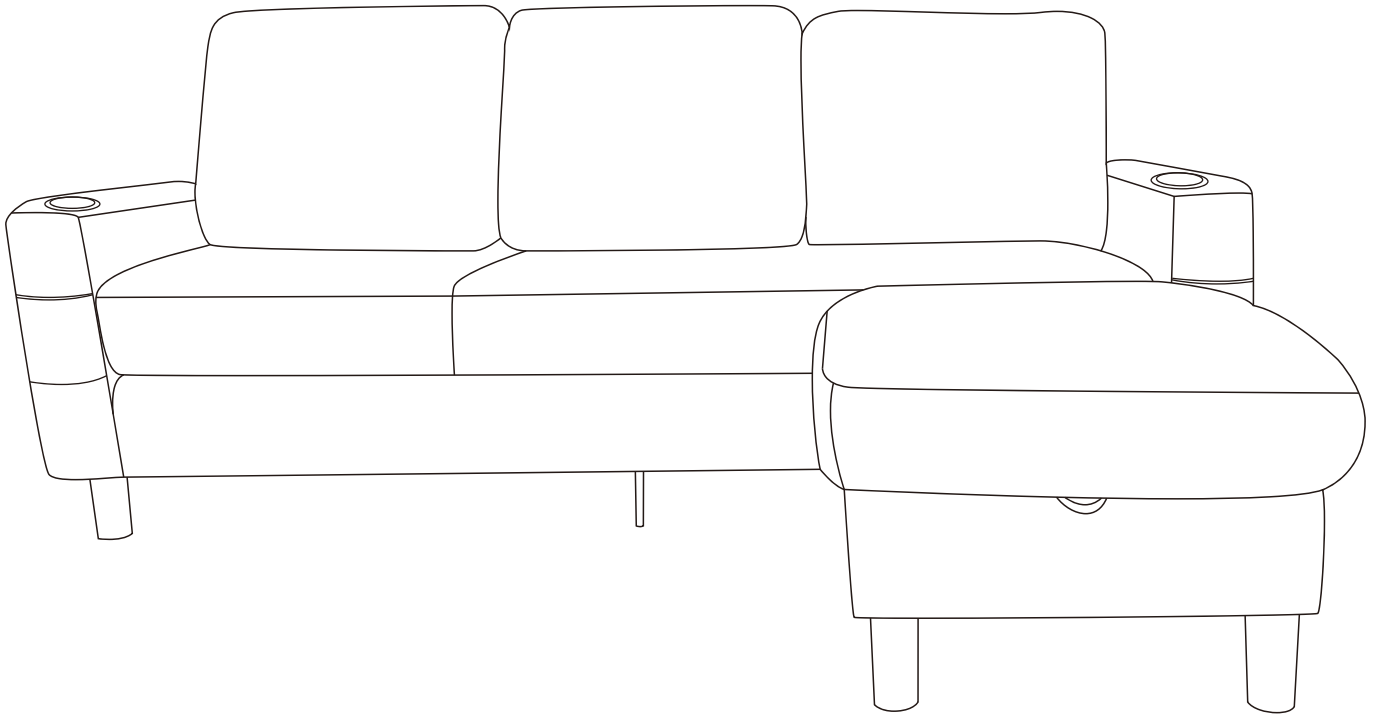

- NOTE: This sofa ships in 2 boxes. All accessories are included.
- If you have any questions after receiving the sofa, please contact us in time and provide pictures. We will try our best to help you solve it. **Email: [sofachairservice@163.com](mailto:sofachairservice@163.com)**











## ! CAUTIONS

1. Keep this instruction manual for future reference
2. It is important to only use this product on a firm, level surface
3. For easier and better assembly, 2 or more adults are required.
4. Remove all packaging and place the components on top of the empty box or on a clean floor to prevent them from becoming scratched
5. Assemble the sofa in the room you intend to use, or as close as possible to that room
6. Carefully follow each assembly step in the correct order to prevent incorrect assembly
7. Do not discard any packaging until the product is fully assembled. This will avoid disposing of any parts
8. Unplug the power cord from the socket before moving the sofa. Disconnect all the power when not in use.
9. Before use, please check whether all flots are installed properly, avoid sofa damage and personal injury caused by abnormal installation.
10. Don't use the sofa in direct sunlight for a long time to avoid material damage.



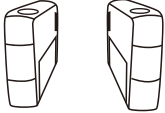
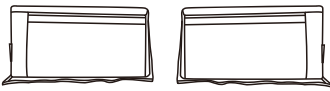

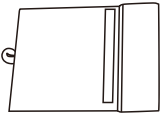
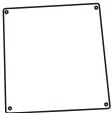
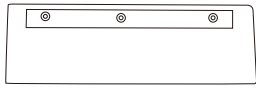

## ! WARNINGS

1. Keep all flame and heat sources away from this sofa, avoid the sofa burning by accidental contact.
2. Never stand or sit on the edge of the armrest, avoid safety accidents caused by sofa rollover.

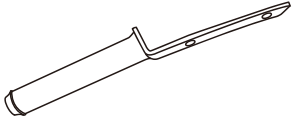
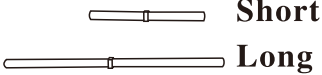
# PARTS LISTING

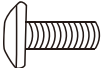
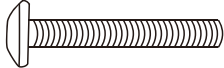
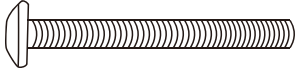
No	Parts	Qty	Description
A1		1pc	Backrest Pillow
A2		1pc	Backrest Pillow
A3		1pc	Backrest Pillow
B1		1pc	Seat Cushion
B2		1pc	Footrest Cushion
C		1pc	Long Seat Cushion
D		2pcs	Armrest (LEFT & RIGHT )
E		2pcs	Backrest (LEFT & RIGHT )
F		2pcs	Seat Frame
G		1pc	Footrest Pad
H		1pc	Footrest Base Pad
I		3pcs	Footrest Side Pad
J		8pcs	Plastic Foot

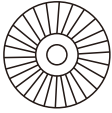
# PARTS LISTING

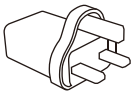
No	Parts	Qty	Description
K		2pcs	Midfoot
L	 Short Long	2pcs	Back Frame Tube
M		4pcs	Footrest Metal Part
N		1pc	Back Frame Metal Part
O	 M6x16mm	18pcs	Screws
P	 M6x40mm	8pcs	Screws
Q	 M6x60mm	4pcs	Screws
R		14pcs	Shim
S		8pcs	Plastic Spacer
T		1pc	Allen Key
U		1pc	Plug

# step1

## NOTE:

When facing the sofa, the armrest with the USB port is on the left side.

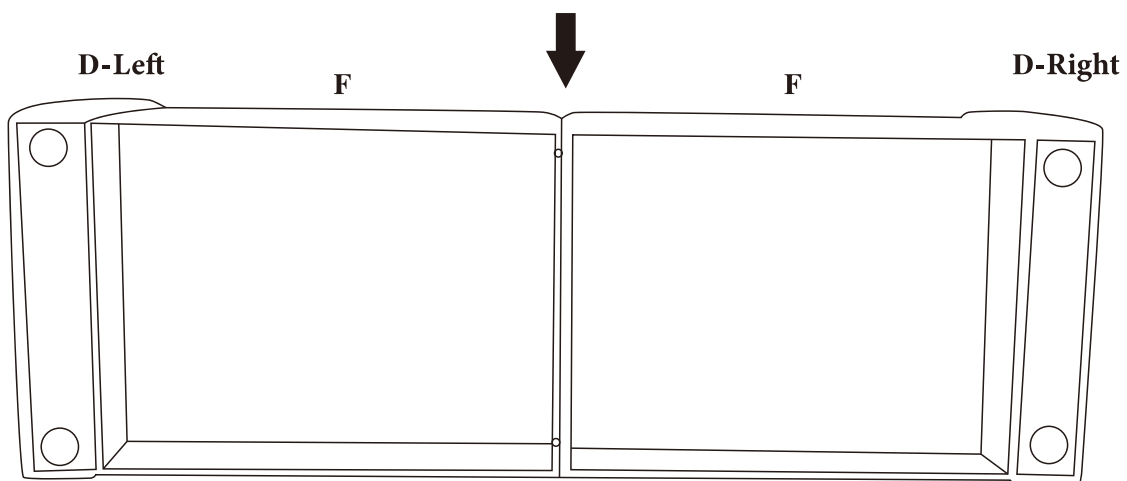
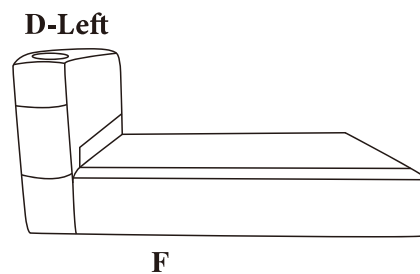
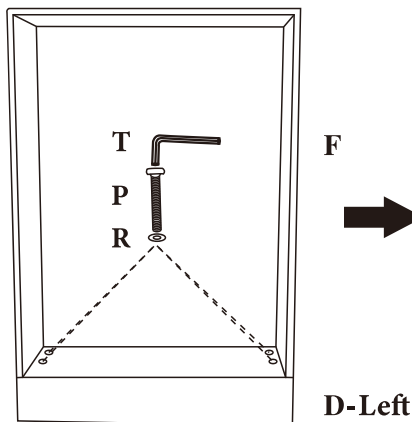
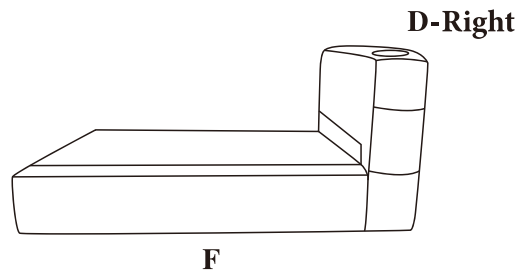
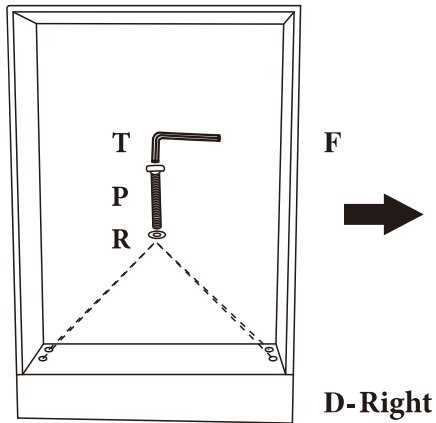

Accessories: Part D (Left & Right), F, T, P, R

Operating Procedure:

Install the Part D-armrests (left and right) onto the F-seat frame, securing them with the Part T-allen key, P-screws, and R-shim.

## step2

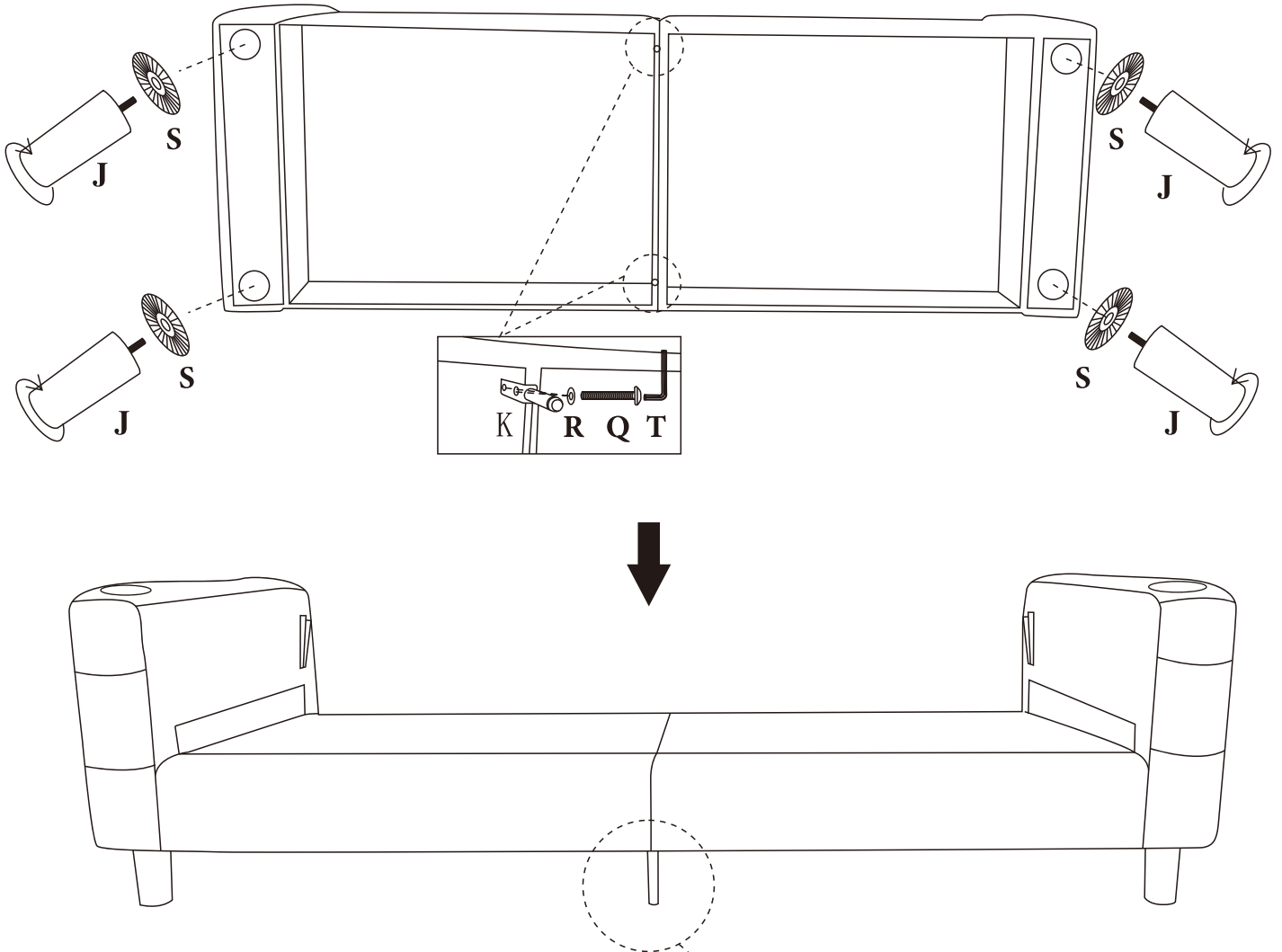

Adjust the leveling feet for balance.

Accessories: Part K, T, Q, R, S, J

Operating Procedure:

2.1 Install the Part K-midfoot onto the F-seat frame, securing it with the Part T-allen key, Q-screws, and R-shim

2.2 Insert the Part J-plastic foot through the Part S-Plastic spacer into the bottom hole, then rotate them until they are fully tightened

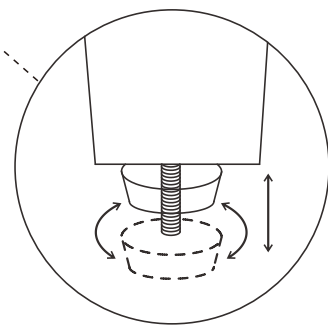

## step3

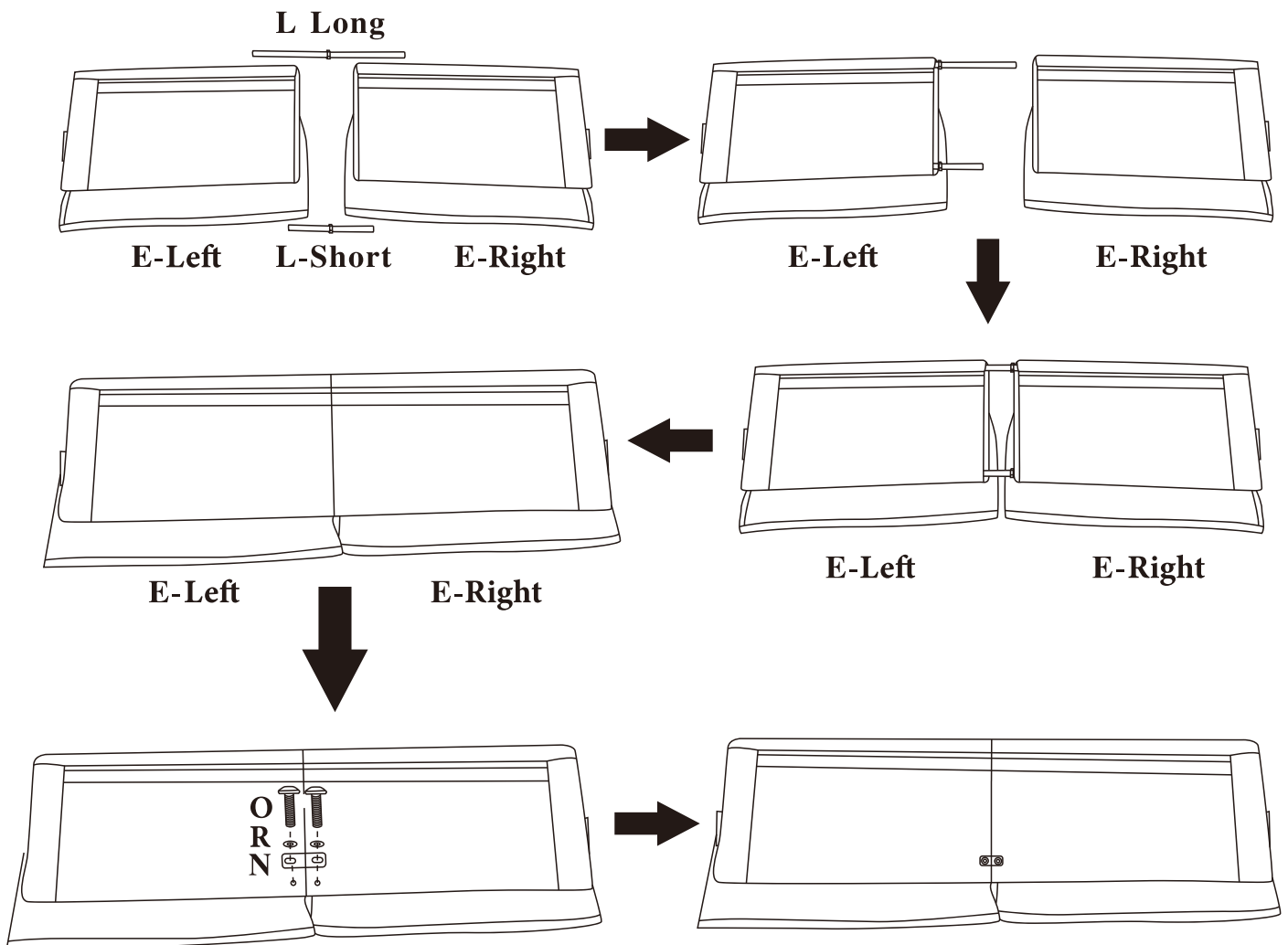

Accessories: Part E (Left & Right), L, O, R, N

Operating Procedure:

Use the Part-L back frame tube to connect the Part E-backrests (left and right), securing them with the Part O-screws, R-shim and N-back frame metal part.

## step4

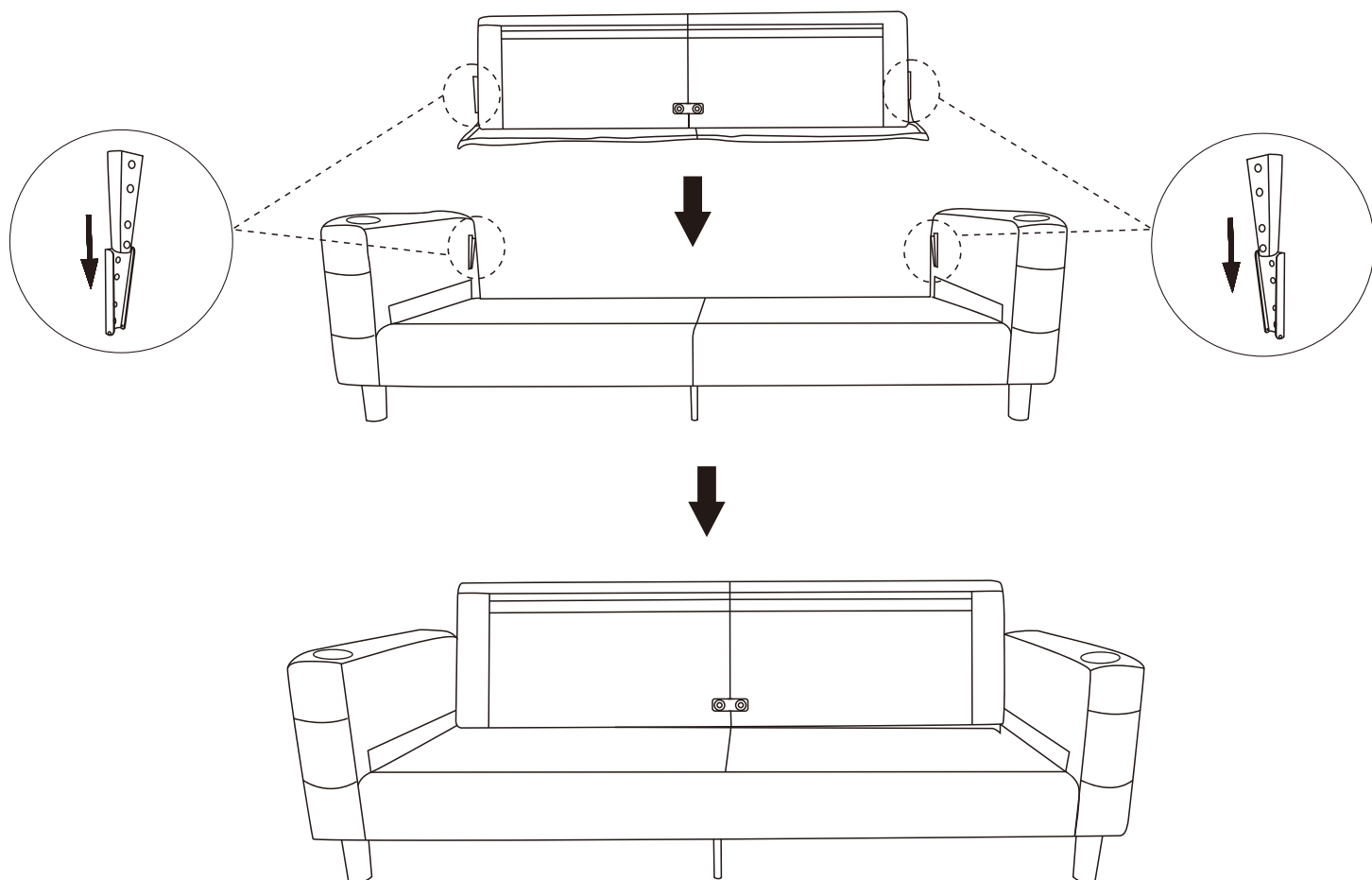

Align the backrests with the slot on the bases and insert them firmly.

Note: Ensure that the backrests are firmly inserted into the bases. Otherwise, they may tilt.

# step5

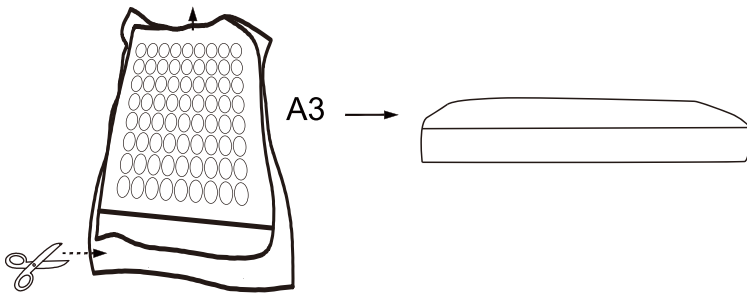
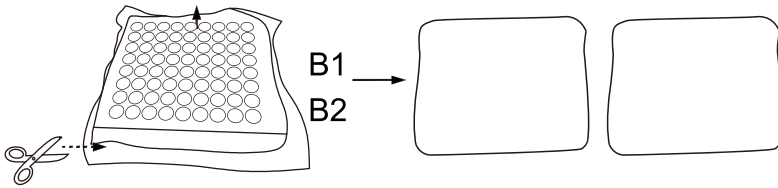
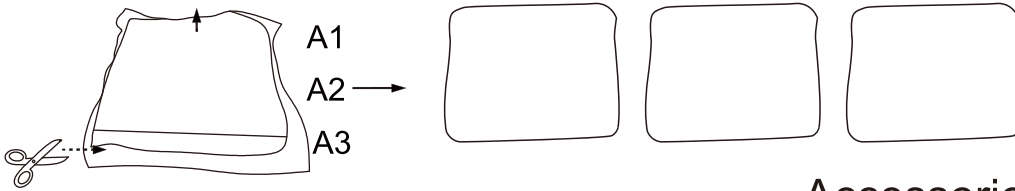

Accessories: Part A1, A2,A3, B1,B2, C

## Operating Procedure:

5.1 Please carefully cut open the vacuum-sealed bag packaging with scissors.

Note: Do not use other knives to cut the stretch film avoid cutting the sofa.

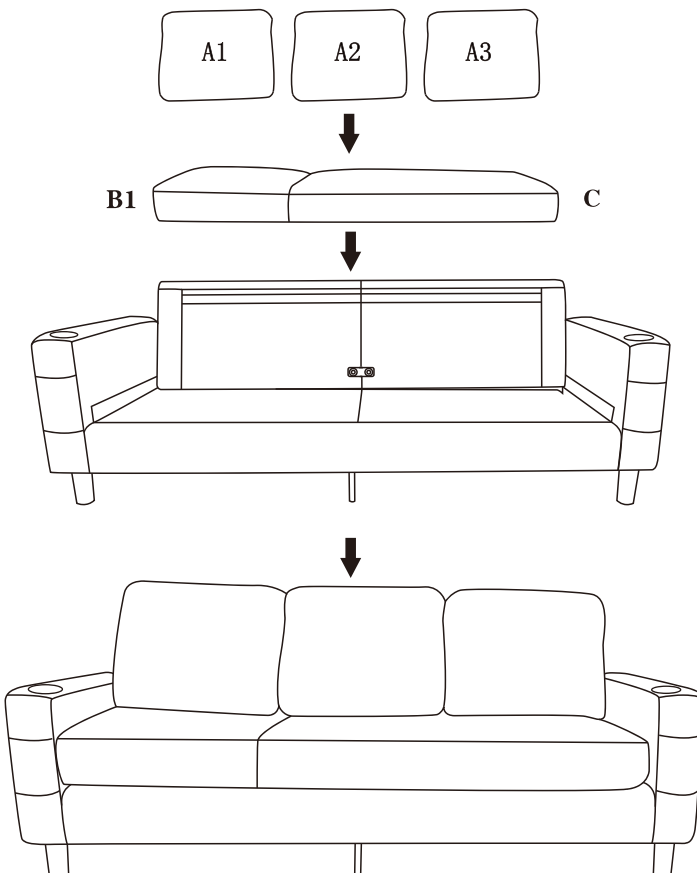

5.2 Place the Part B1-seat cushion, C-long seat cushion, and A-backrest pillows on the sofa frame.

## step6

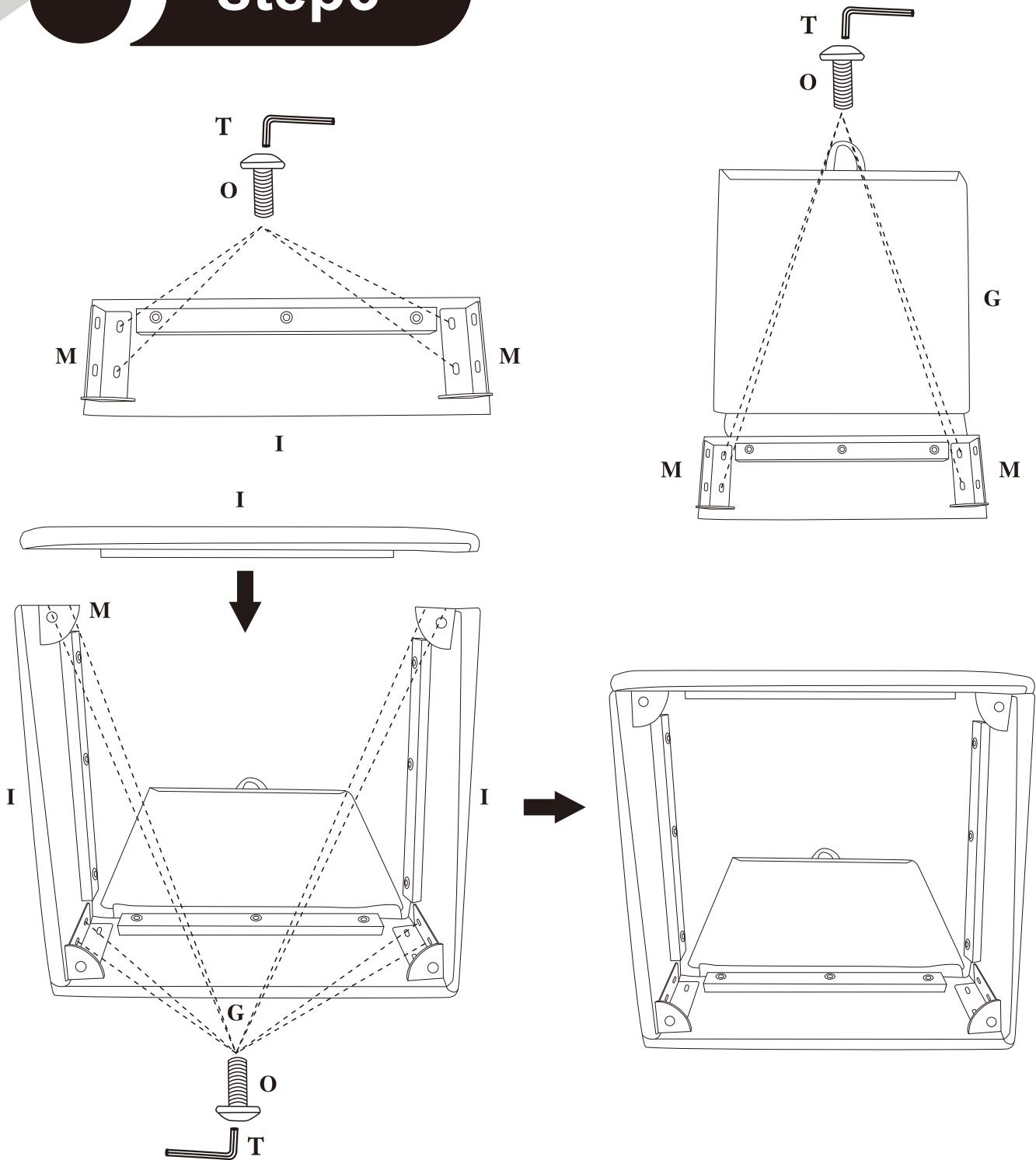

Accessories: Part M, I, G, O, T

Operating Procedure:

Install the Part M-footrest metal part onto the I-footrest side pad and G-footrest pad, securing them with the Part T-alen key and O-screws

# step7

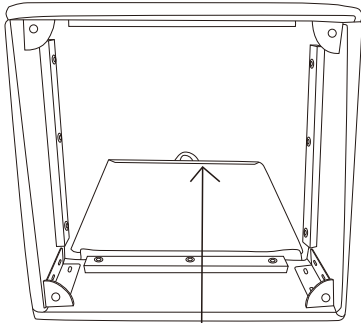

H

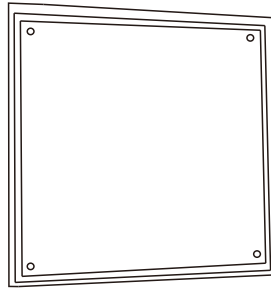
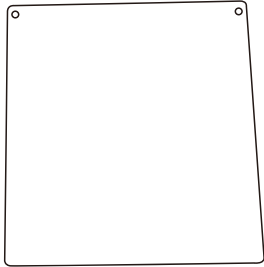

Accessories: Part H, S, J, B2

Operating Procedure:

7.1 Place the Part H-footrest base pad under the footstool frame.

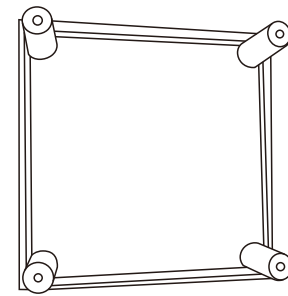
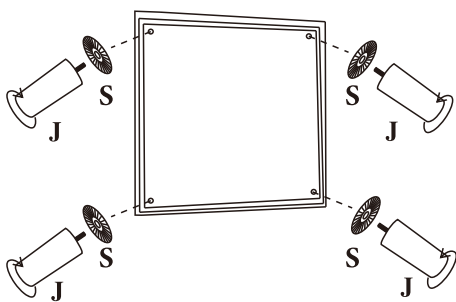

7.2 Insert the Part J-plastic foot through the Part S-Plastic spacer into the bottom hole, then rotate them until they are fully tightened.

Place the Part B2-footrest cushion on the footstool frame.

B2

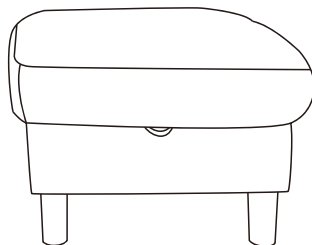
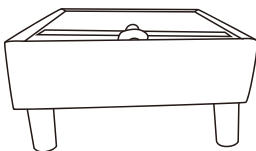
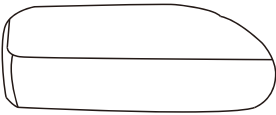

## step 8

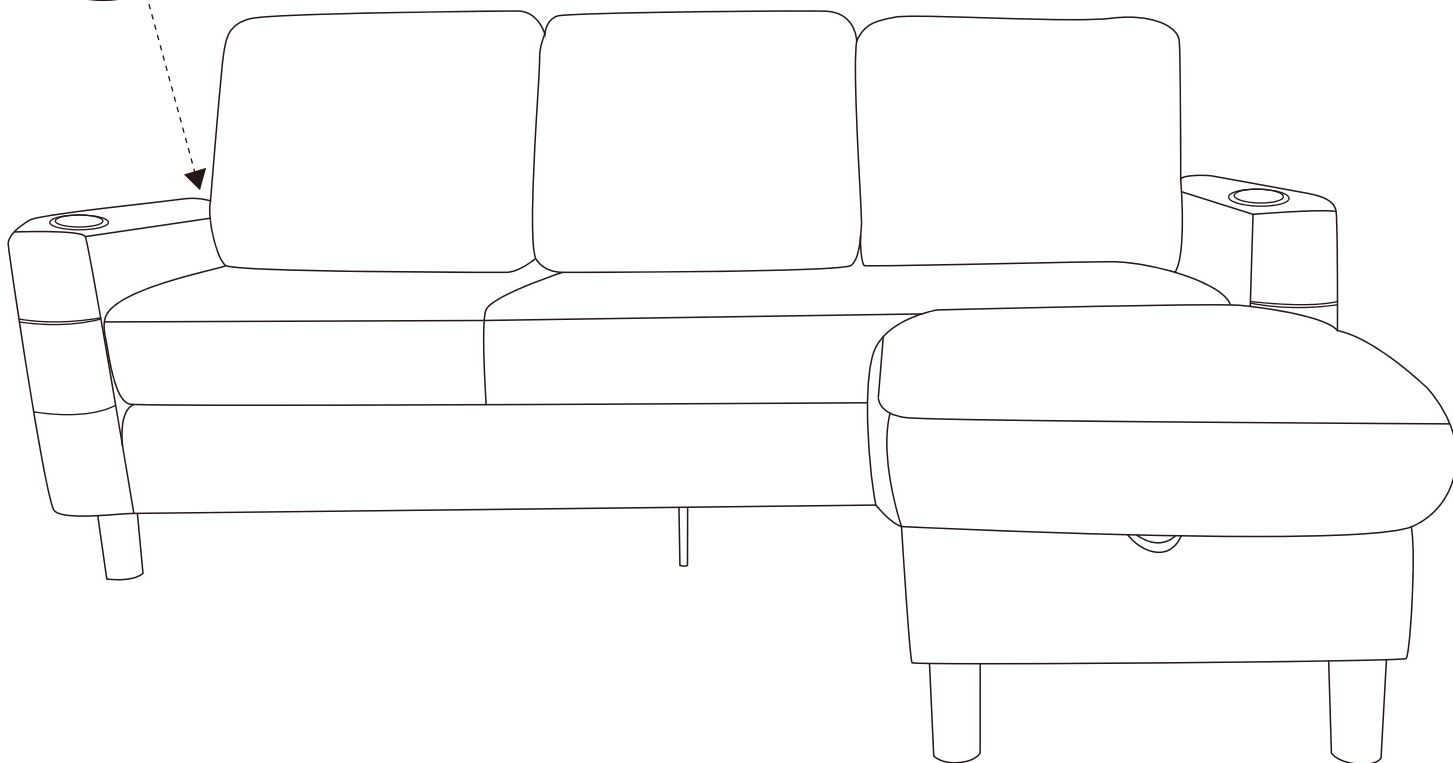
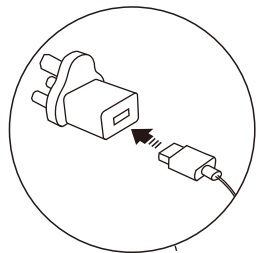

Accessories: Part U

Operating Procedure:

Connect the Part U-plug to the wire from the left armrest, as shown in the figure.

Finished

## WARRANTY

- The quality of our products has been strictly controlled. Each stage of the product upgrading has condensed the efforts of employees in various departments. We strive to minimize the probability of failure of new products and insist on providing customers with worry less after-sales service.
- If you have any damage or quality problems after receiving the goods, please contact us in time, our professional after-sales team will reply you as soon as possible and help you solve it.
- In order to save your time, please describe the problem in detail.If possible, we hope you can upload product pictures for our reference, and inform us the part number according to the instructions.

## AFTER-SALE POLICY

- In order to better provide after-sales service experience, we provide the following after-sales policies. At the same time, we also hope that you can actively cooperate with us.
- Within the warranty period of the product, In case of product quality problems, you can contact us, we can provide you with parts replacement services, but for functional issues, we hope you could cooperate with us to complete the troubleshooting steps we told you and inform us the result so we could help you solve it.
- For the return problem, we do not accept unreasonable refunds.If you are not satisfied within 3 days after receiving the goods, we hope you can contact us as soon as possible. After we checked,you must return the product in their original status, so you could qualify for a refund.

UK REP

Name: Sea&Mew Accounting Ltd  
Address: Electric Avenue Vision 25,  
London, Enfield EN3 7GD  
Contact Person: Billy Han  
E-mail: info@seamew.net  
Tel:+44 7399648608

EC REP

Name: Sea& Mew Consulting GmbH  
Address: Mittenhuber StraÙ e 4,92318  
Neumarkt  
Contact Person: Yuan Li  
Email: Compliance.EU@ outlook. com  
Tel:+4915224685061



Filling material(s) and covering fabric(s) meet the requirements for resistance to cigarette and match ignition in the Furniture and Furnishings(Fire)(Safety) Regulations 1988

**CARELESSNESS  
CAUSES FIRE**

