

WARNING

- * Switch off the main electrical supply from the main fuse box / circuit breaker before installation.
- * Inspect item carefully before attempting to install.
- * If there is any damages or obvious defects, do not install.
- * Item may not be returned once it has been installed.

CARE AND MAINTENANCE

- * To clean the outside of the fixture, use a dry or slightly dampened clean cloth (use clean water, never a solvent) to wipe the surface of the fixture.
- * To clean the inside of the fixture, first disconnect power to the fixture by turning off the circuit breaker or by removing the fuse at the fuse box. Next, use a dry or slightly dampened clean cloth (use clean water, never a solvent) to wipe the interior surface of the fixture.
- * Do not use any cleaners with chemical, solvents or harsh abrasives. Use only a dry soft cloth to dust or wipe carefully.

NOTICE& IMPORTANT SAFETY INSTRUCTIONS







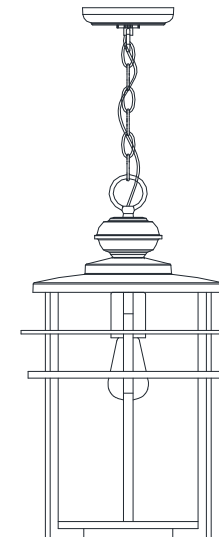





- * Please make sure that you have all parts indicated before you begin assembly of this item
- * This item should be assembled on a soft surface to prevent scratching the finish during assembly
- * To reduce the risk of fire, electrical shock or injury to persons or property, please follow the guideline below for safe use and installation
- *The external flexible cable or cord of this luminaire cannot be replaced
If the cord is damaged, the luminaire shall be destroyed

Owner Manual

Product Dimensions: 7.5"D X 17.5 - 89.5"H



Part List and Hardware List

PIECE	DESCRIPTION	PICTURE	QUANTITY	PIECE	DESCRIPTION	PICTURE	QUANTITY	PIECE	DESCRIPTION	PICTURE	QUANTITY
A	machine screw		1X	F	canopy		1X	J	socket ring		1X
B	mounting bracket		3X	G	chain		1X	K	bulb		2X
C	screw loop		2X	G1	fixture		2X				
D	Ring		1X	H	iron rack		1X				
E	wire nut		1X	I	Glass		1X				

PREPARATION

- * Before beginning assembly of product, make sure all parts are present. Compare parts with package contents list and hardware contents list.
- * If any part is missing or damaged, do not attempt to assemble the product.
- * Estimated Assembly Time: 20 minutes.
- * Tools Required for Assembly (not included): Screwdriver, Junction box
- * If you are having difficulty, our friendly Customer Care team is always here to help.

NOTE: PLEASE USE TYPE "A" BULB MAX 40-WATT OR LED BULB MAX 9-WATT, THERE ARE 1PCS LED 4-WATT BULB IN THE BOX

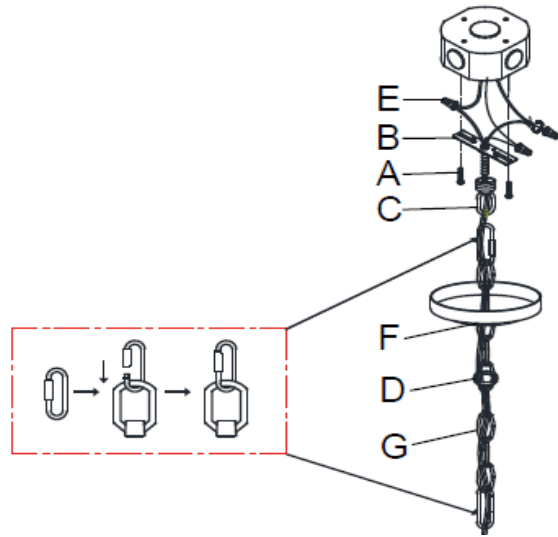

Step 1:

Remove the ring (D) and screw collar loop (C) from the preassembled threaded nipple on the mounting bracket (B). Mount the mounting bracket (B) to the junction box with machine screws (A).

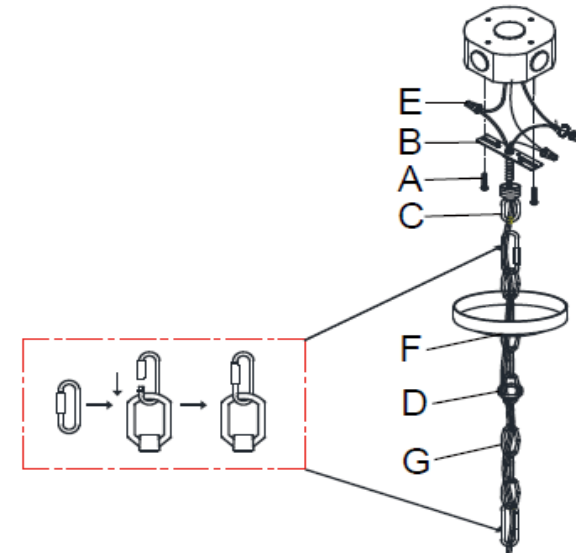

Step 2:

Attach the screw collar loop (C) to the threaded nipple of the mounting bracket (B). Choose the desired length. Use a soft cloth and pliers (none included) to avoid damaging the finish. Open the top section of the chain (G) and attach it to the screw collar loop (C). Pass the chain (G) through the canopy (F) and ring (D). Then weave the fixture wire and the fixture ground wire from the fixture (H) through the chain (G), ring (D), canopy (F).

PREPARATION

- * Before beginning assembly of product, make sure all parts are present. Compare parts with package contents list and hardware contents list.
- * If any part is missing or damaged, do not attempt to assemble the product.
- * Estimated Assembly Time: 20 minutes.
- * Tools Required for Assembly (not included): Screwdriver, Junction box
- * If you are having difficulty, our friendly Customer Care team is always here to help.

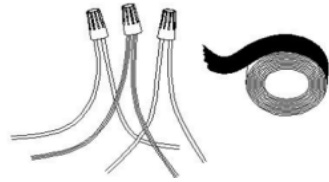
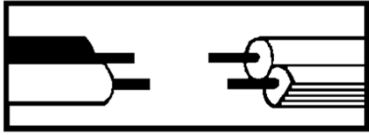

Step 3:

Make wire connections, with wire nut(B)

Connect fixture neutral wire (ribbed) to the outlet box neutral wire (usually white) using a wire nut. Connect fixture hot wire (smooth with markings) to the outlet box hot wire (usually black) using a wire nut.

CAUTION: Do not reverse the hot and neutral connections

Grounding Instructions:

Wrap ground wire from outlet box around green ground screw(Q) on mounting bracket, no less than 2" from wire end. Tighten ground screw. If fixture is supplied with a ground wire, connect to outlet ground wire with a wire nut.

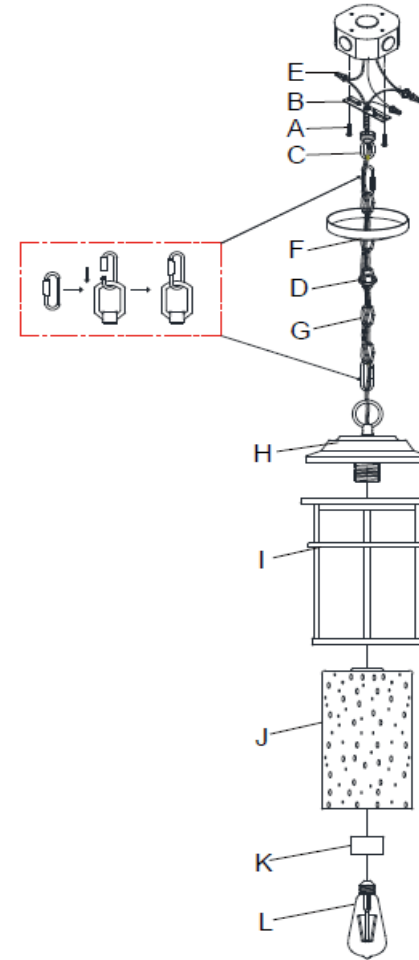

Step 4:

Tighten the ring(D) onto the screw collar loop(C) to secure the canopy(F) over the mounting bracket (B). Open the bottom section of the chain(G) and attach it to the fixture(H).

Attach the glass shade(J) and iron rack(I) onto fixture(H) using socket ring (K). Screw the Bulb (L) into the socket.