





# ASSEMBLY INSTRUCTIONS

MODEL : LWM(CV-G4)15908HFTS2(95H)

ITEM	PART NAME	QTY
1	Table Top & Apron 	1 PC
2	Leg 	4 PCS

ITEM	HARDWARE LIST	DESCRIPTION	QTY
A	JCBB M8 x 60		8 PCS
B	Spring Washer M8		8 PCS
C	Flat Washer M8		8 PCS
D	Allen Key M5		1 PC

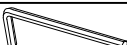
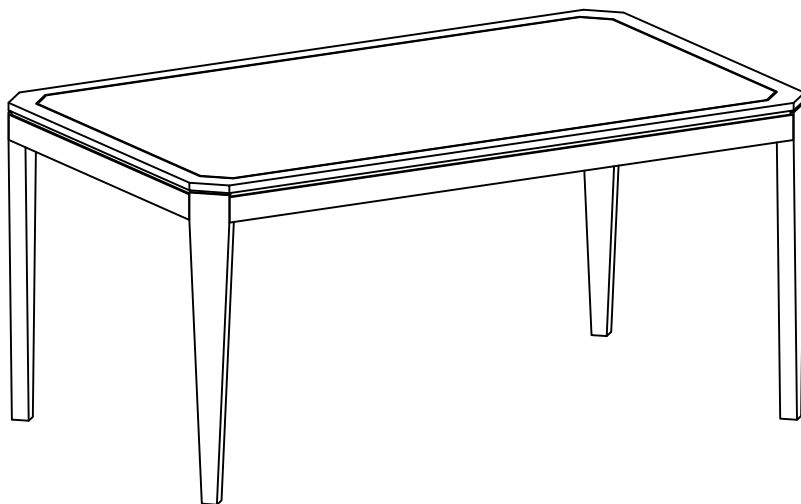

## STEP 1

