

CLASSIC TV STAND

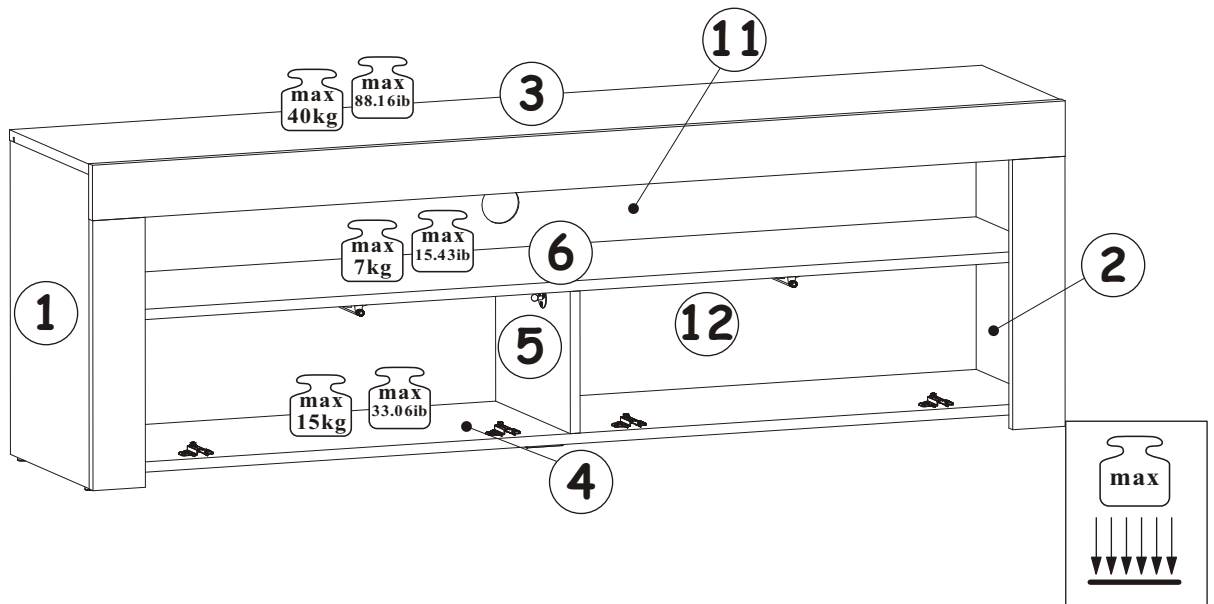

NO	Dim			Col.-No	Qty
1	482	332	16	1	1
2	482	332	16	1	1
3	1576	332	16	2	1
4	1542	312	16	2	1
5	218	312	16	1	1
6	1542	312	16	2	1
7	698	246	16	1	2
8	1577	85	18	2	1
9	414	85	18	1	1
10	414	85	18	1	1
11	1554	226	3	2	1
12	1554	239	3	2	1

NO	Inch			Col.-No	Qty
1	18 31/32	13 5/64	5/8	1	1
2	18 31/32	13 5/64	5/8	1	1
3	62 3/64	13 5/64	5/8	2	1
4	60 45/64	12 9/32	5/8	2	1
5	8 37/64	12 9/32	5/8	1	1
6	60 45/64	12 9/32	5/8	2	1
7	27 31/64	9 11/16	5/8	1	2
8	62 3/32	3 11/32	45/64	2	1
9	16 19/64	3 11/32	45/64	1	1
10	16 19/64	3 11/32	45/64	1	1
11	61 3/16	8 57/64	1/8	2	1
12	61 3/16	9 13/32	1/8	2	1

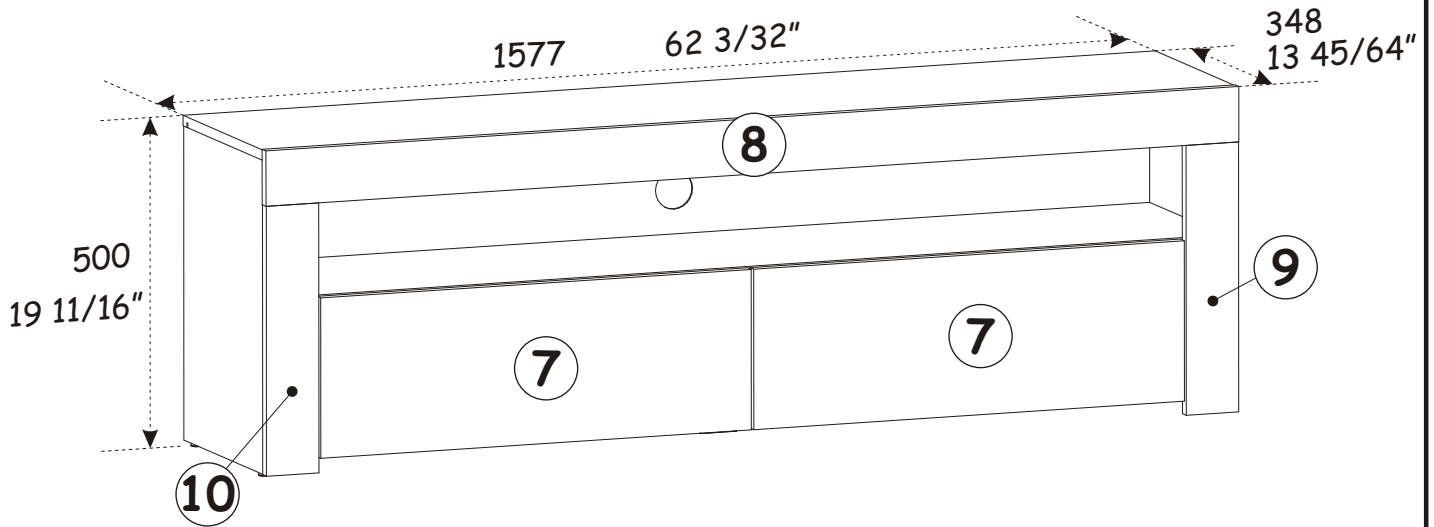
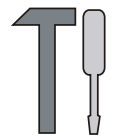
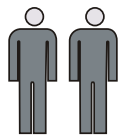

90 min

CLASSIC TV STAND

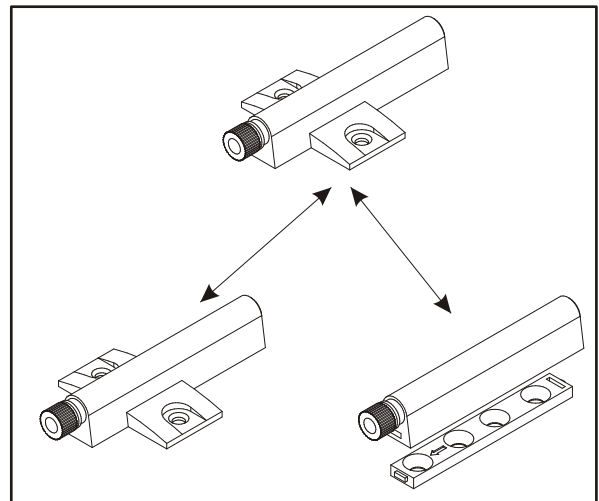
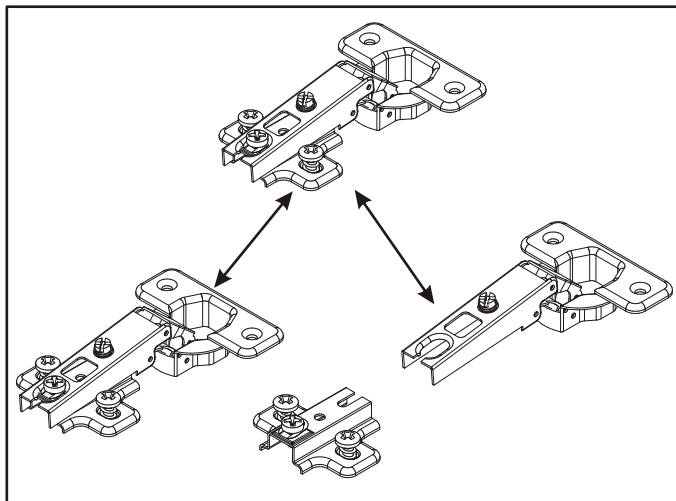
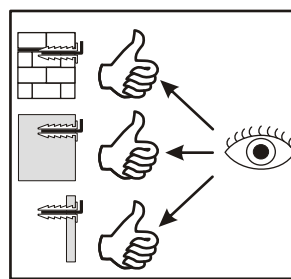
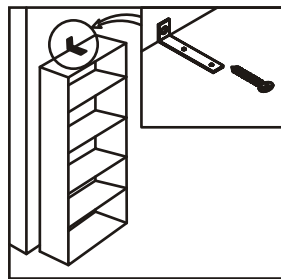
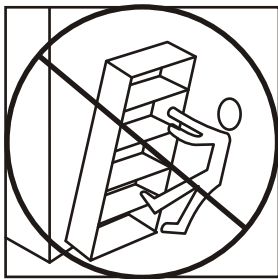
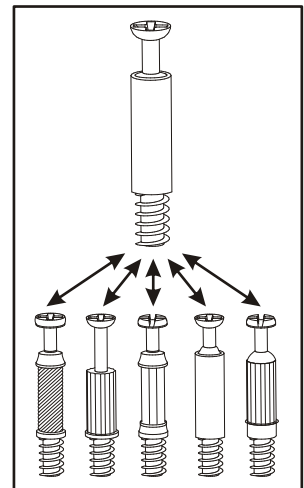
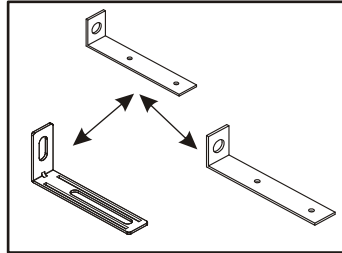
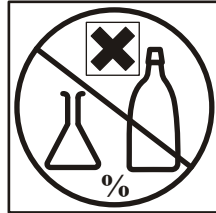
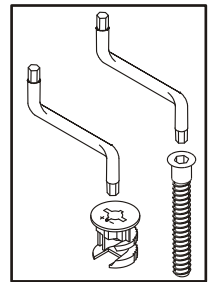
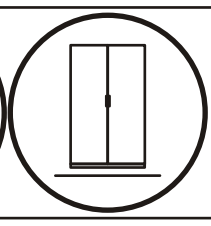
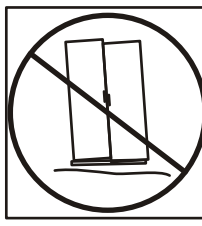
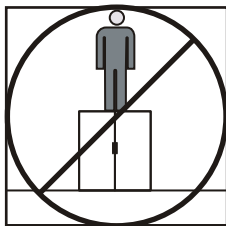
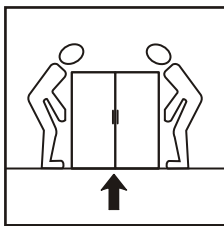
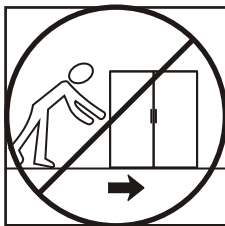
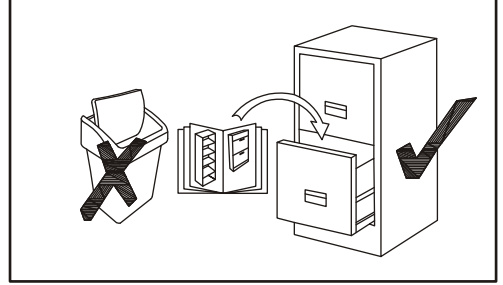
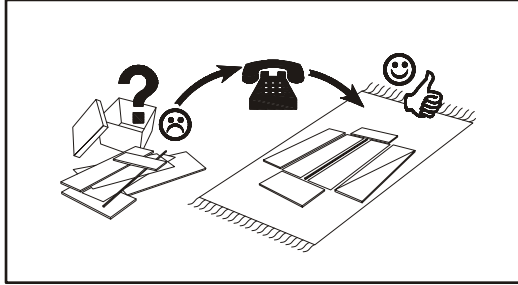
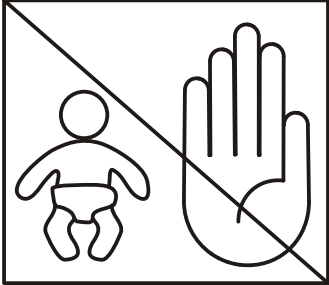
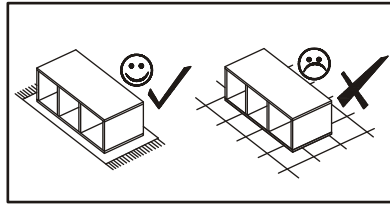
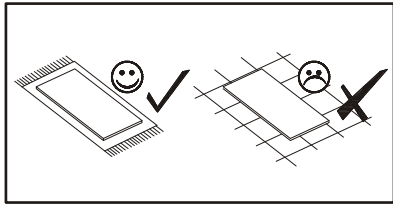

CLASSIC TV STAND

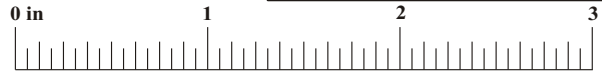
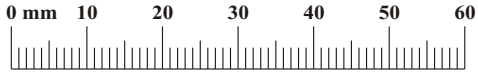
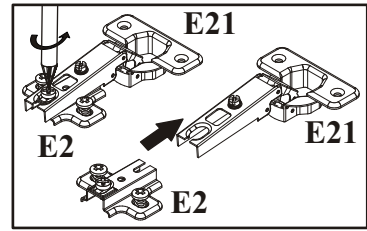
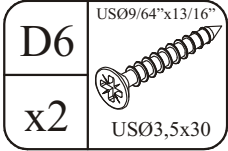
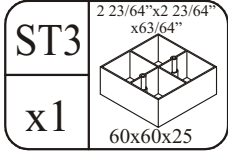
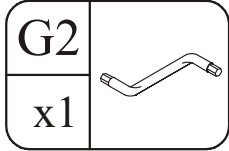
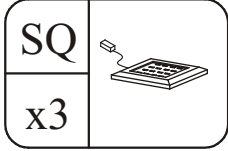
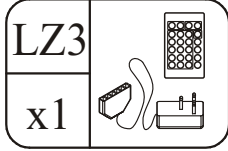
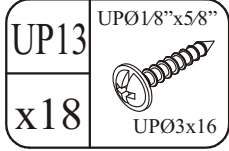
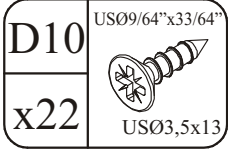
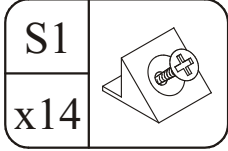
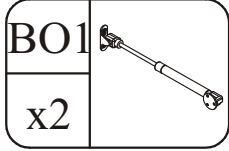
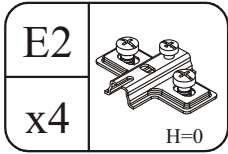
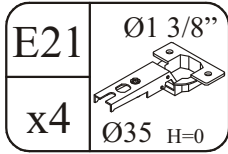
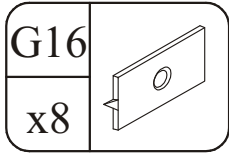
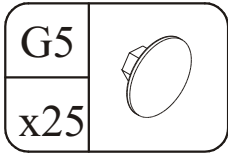
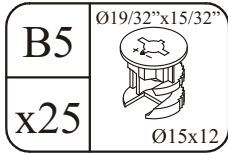
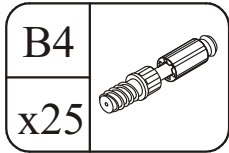
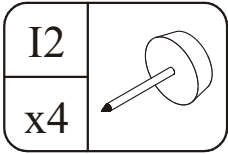
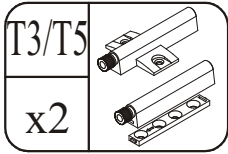
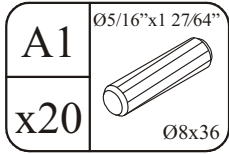

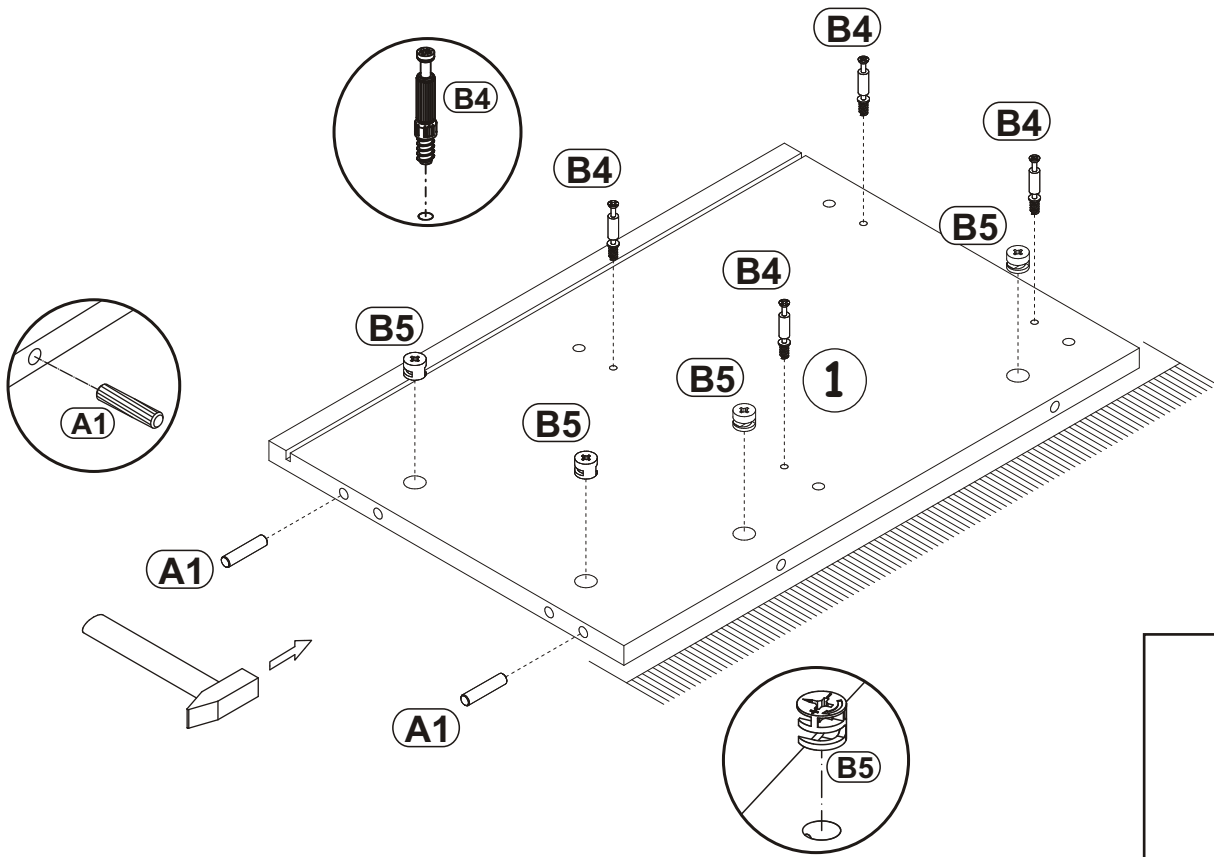
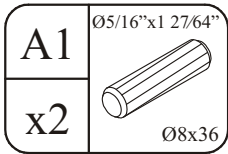
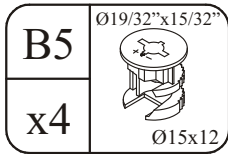
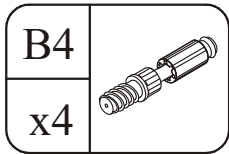

1

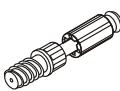

CLASSIC TV STAND

2

B4	
x4	

B5	
x4	$\text{Ø}19/32 \times 15/32$ $\text{Ø}15 \times 12$

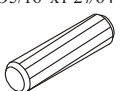
A1	
x2	$\text{Ø}5/16 \times 1\ 27/64$ $\text{Ø}8 \times 36$

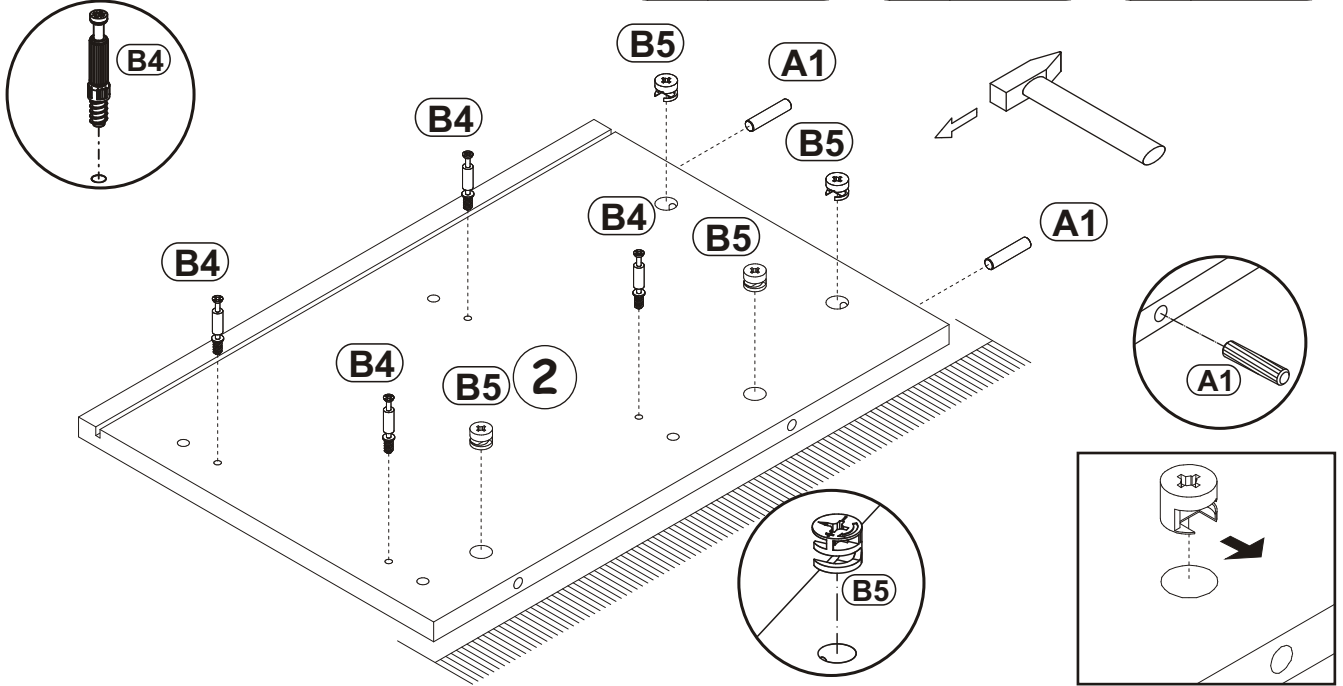

3

SQ	
x3	

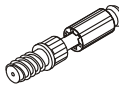

B4	
x4	

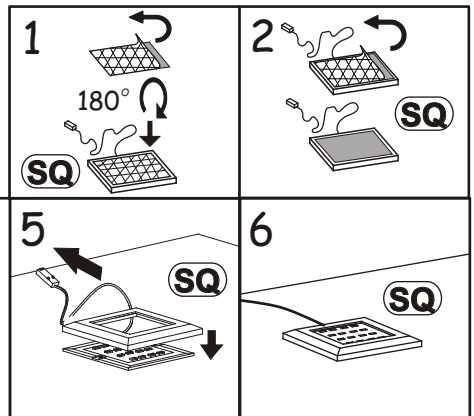
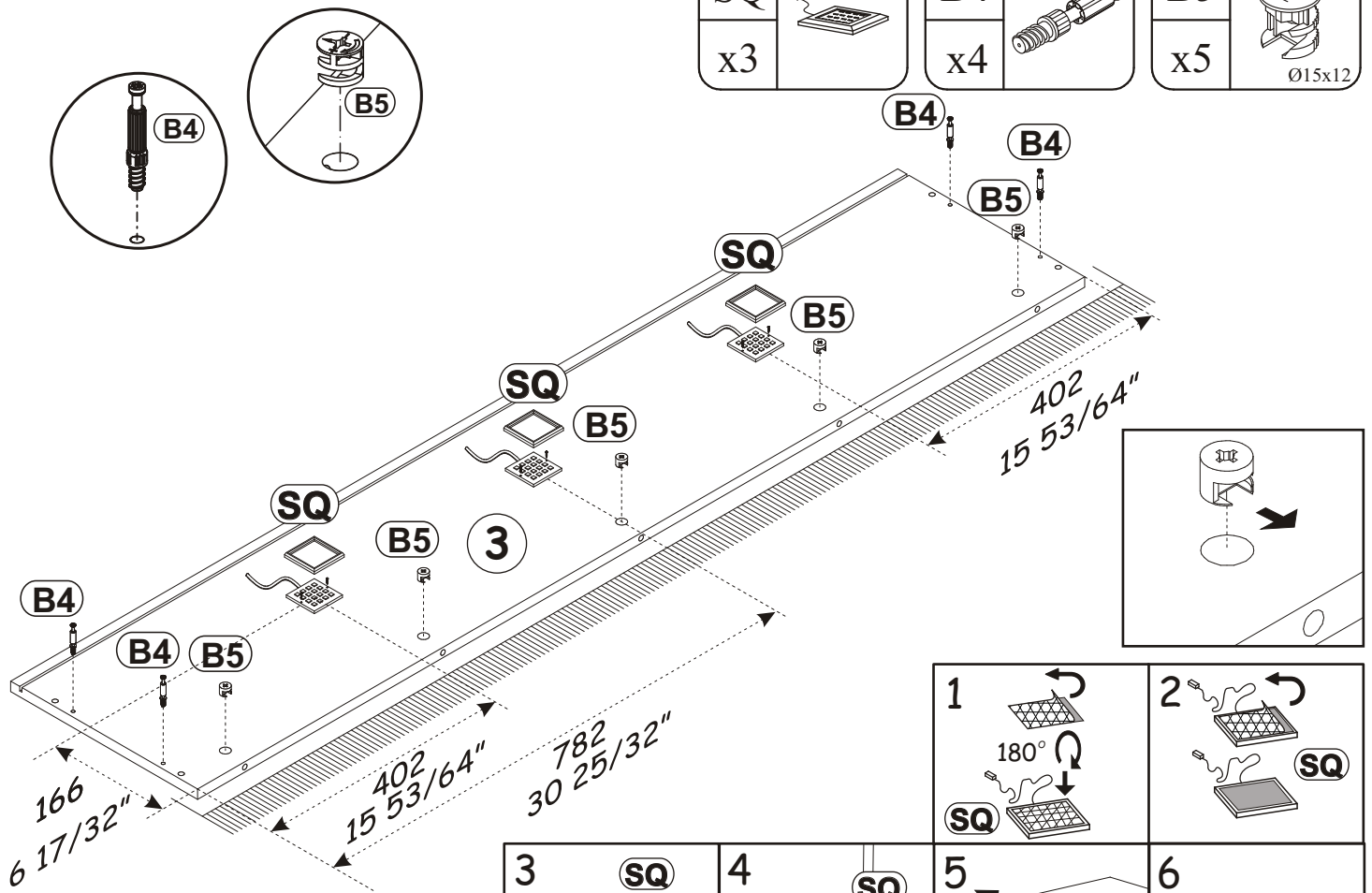
B5	
x5	$\text{Ø}19/32 \times 15/32$ $\text{Ø}15 \times 12$

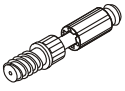
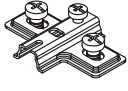

CLASSIC TV STAND

4

ST3	2 23/64"x2 23/64" x63/64" 60x60x25	A1	Ø5/16"x1 27/64" Ø8x36	B4	
x1		x4		x2	
D6	USØ9/64"x13/16" USØ3,5x30	E2	 H=0	B5	Ø19/32"x15/32" 
x2		x4		x4	

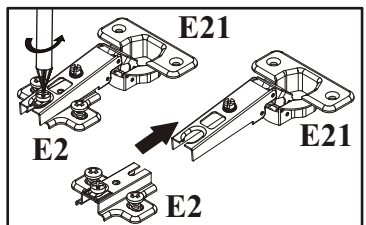
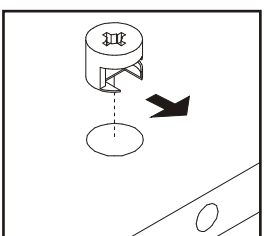
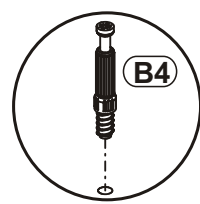
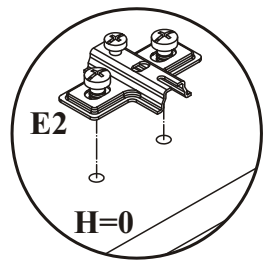
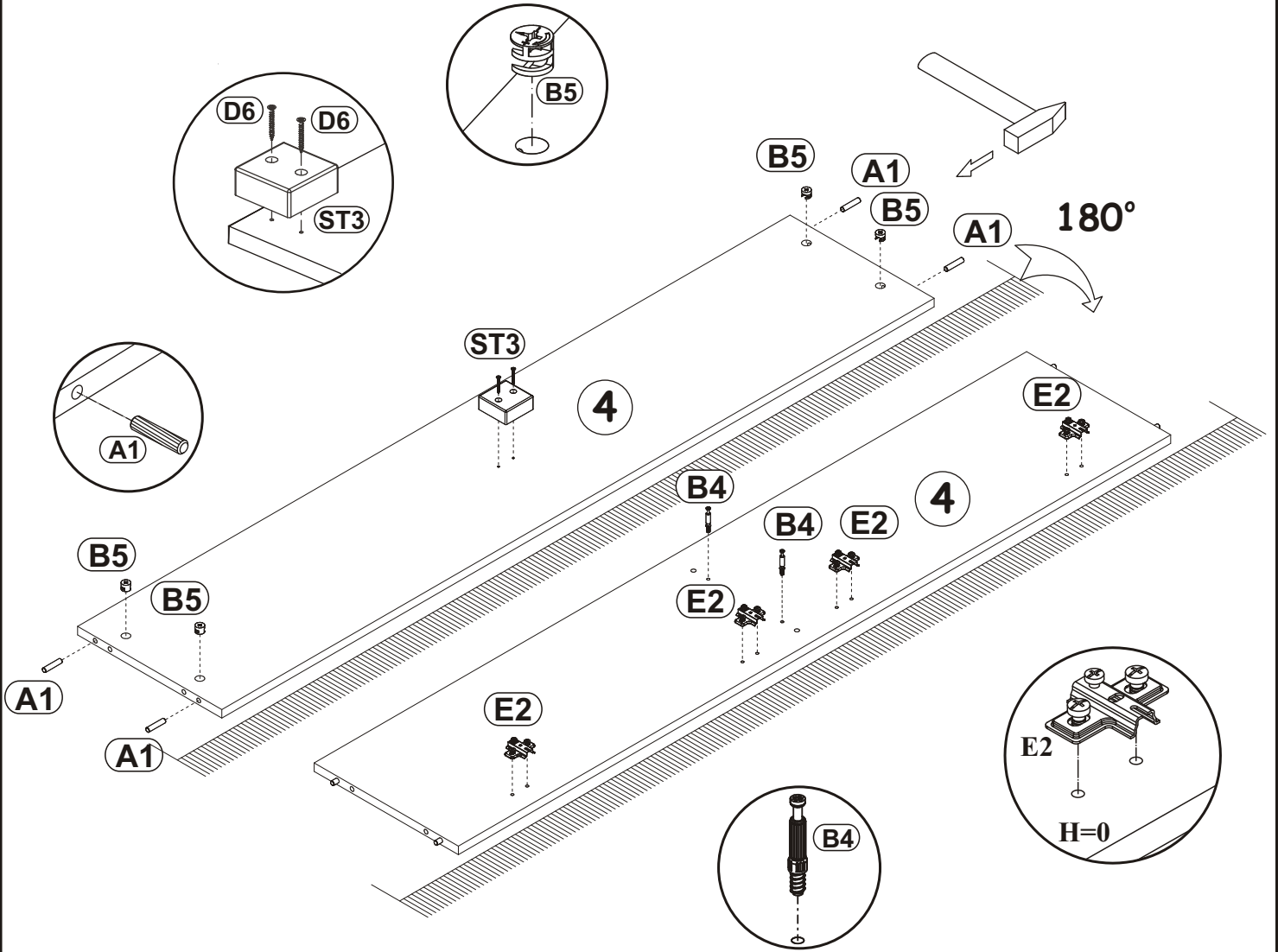

CLASSIC TV STAND

5

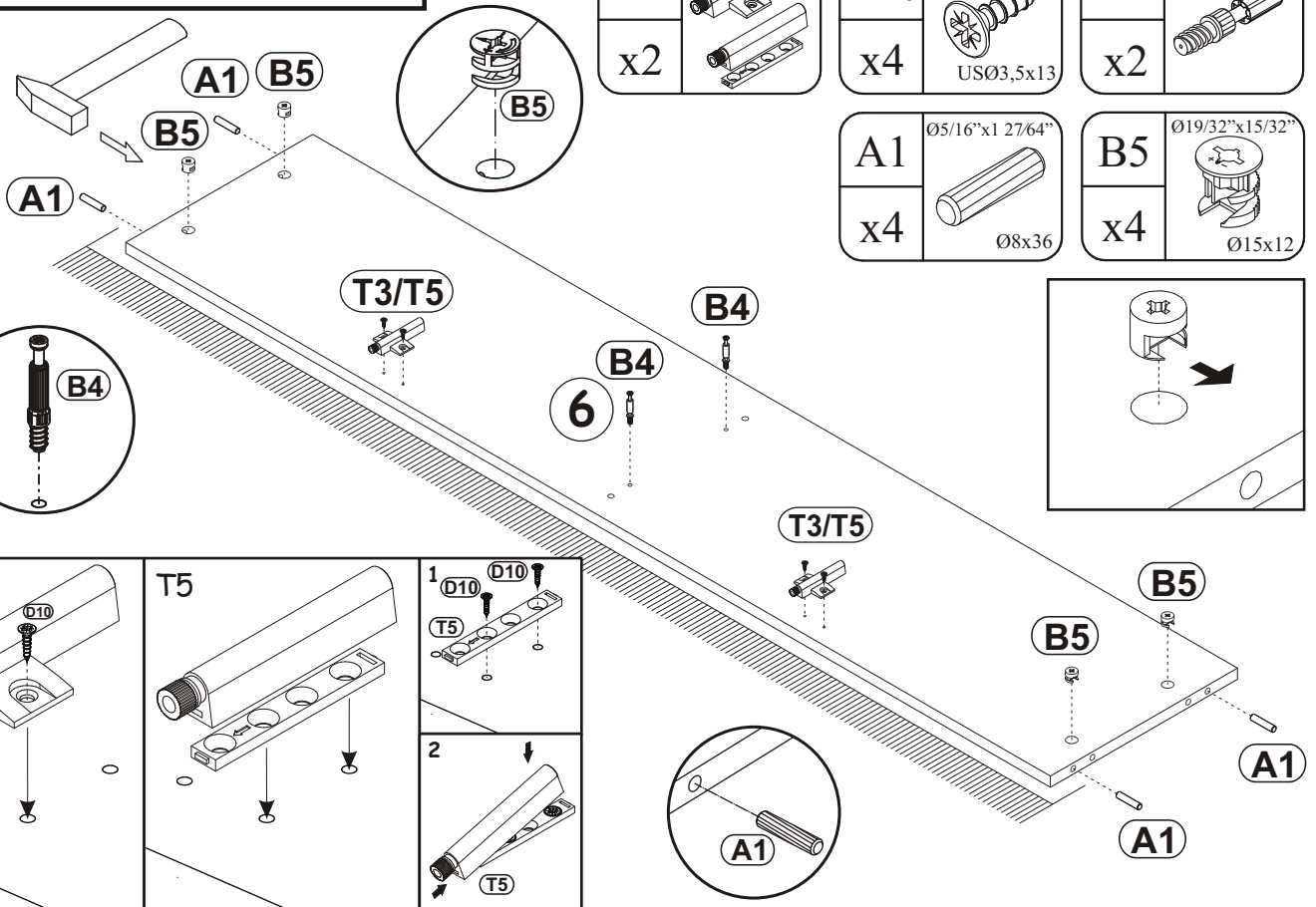

T3/T5	
x2	

D10	US09/64"x33/64"
x4	US03,5x13

B4	
x2	

A1	05/16"x1 27/64"
x4	Ø8x36

B5	Ø19/32"x15/32"
x4	Ø15x12

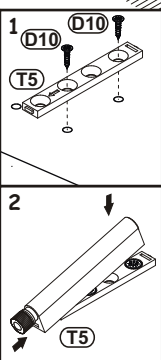
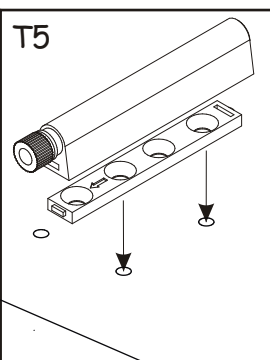
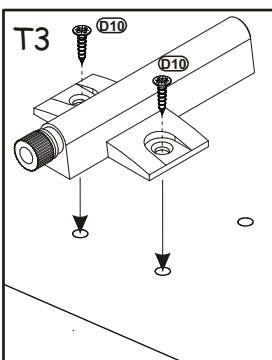

6

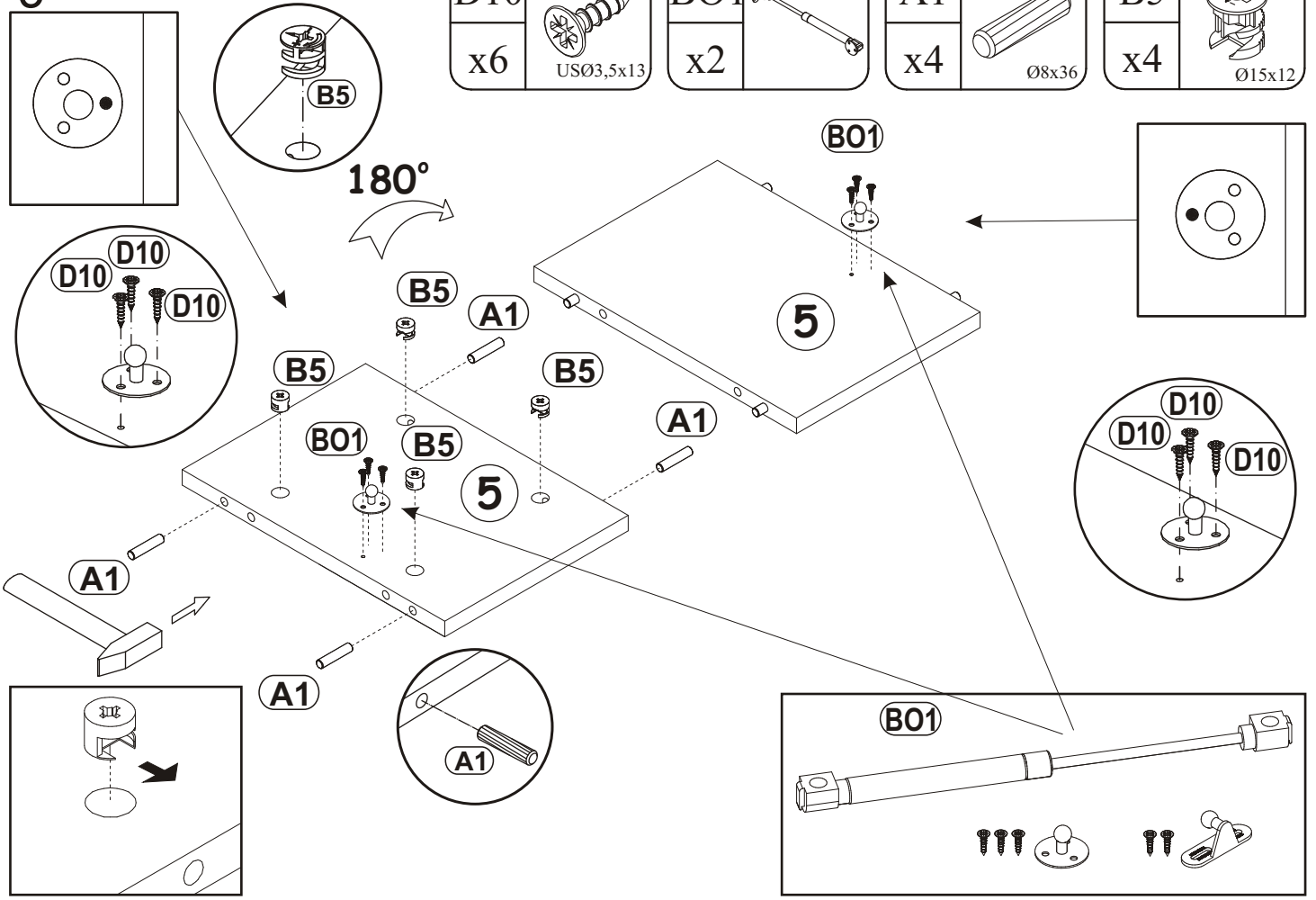

D10	US09/64"x33/64"
x6	US03,5x13

B01	
x2	

A1	05/16"x1 27/64"
x4	Ø8x36

B5	Ø19/32"x15/32"
x4	Ø15x12

7

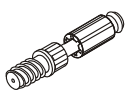
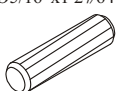
B4		A1	
x9		x4	Ø5/16"x1 27/64" Ø8x36

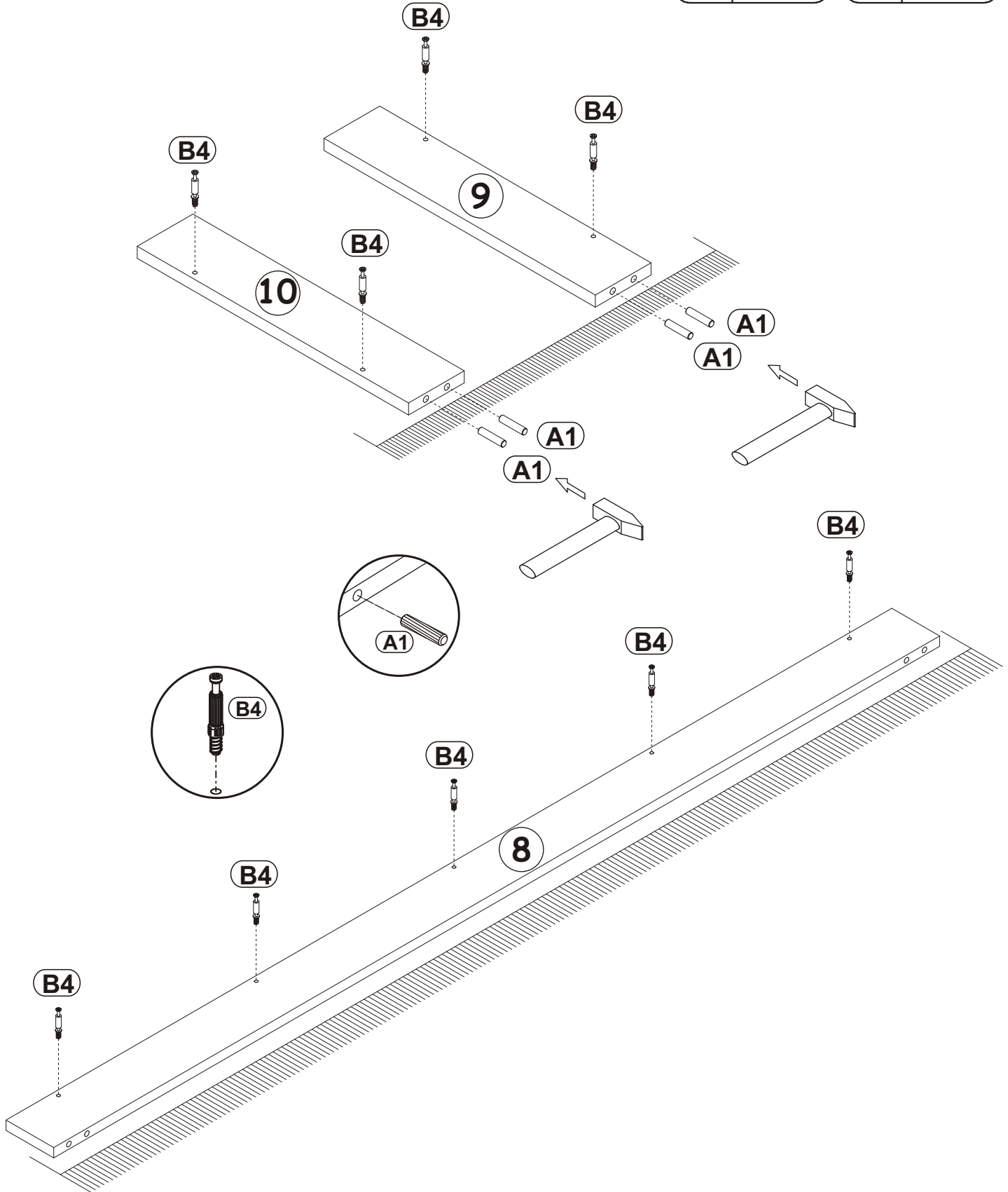

CLASSIC TV STAND

8

D10	US09/64"x33/64" 
x12	US03,5x13

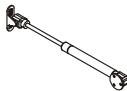
BO1	
x2	

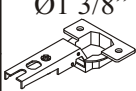
E21	Ø1 3/8" 
x4	Ø35 H=0

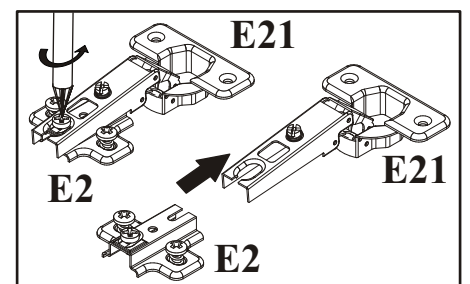
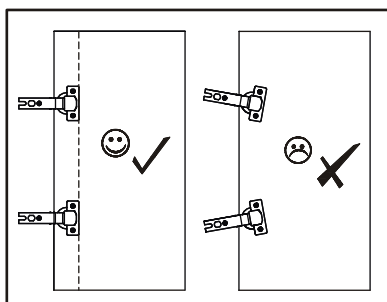
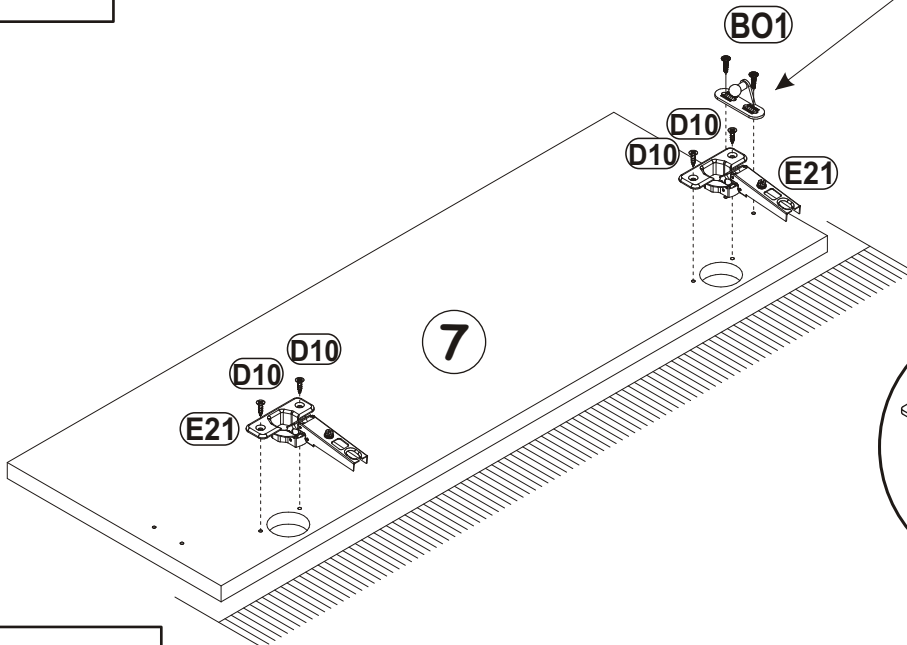
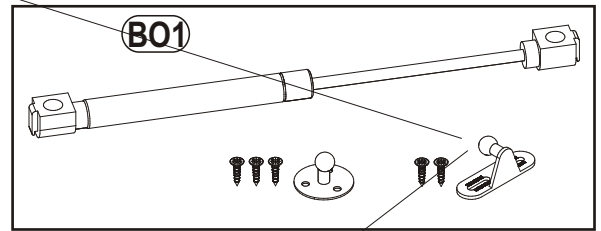
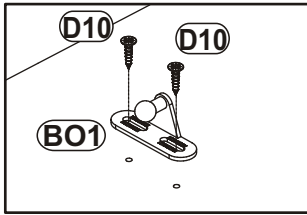
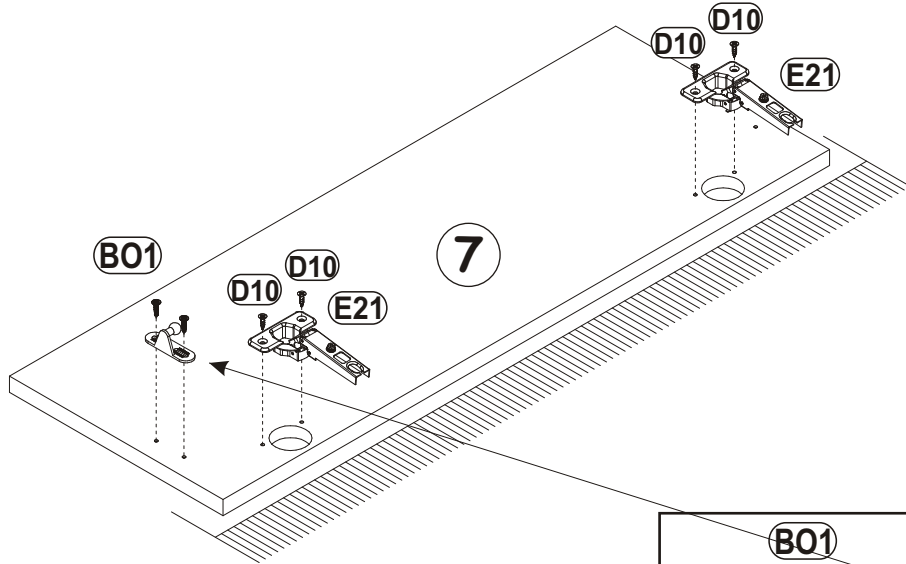

CLASSIC TV STAND

9

G5

x4

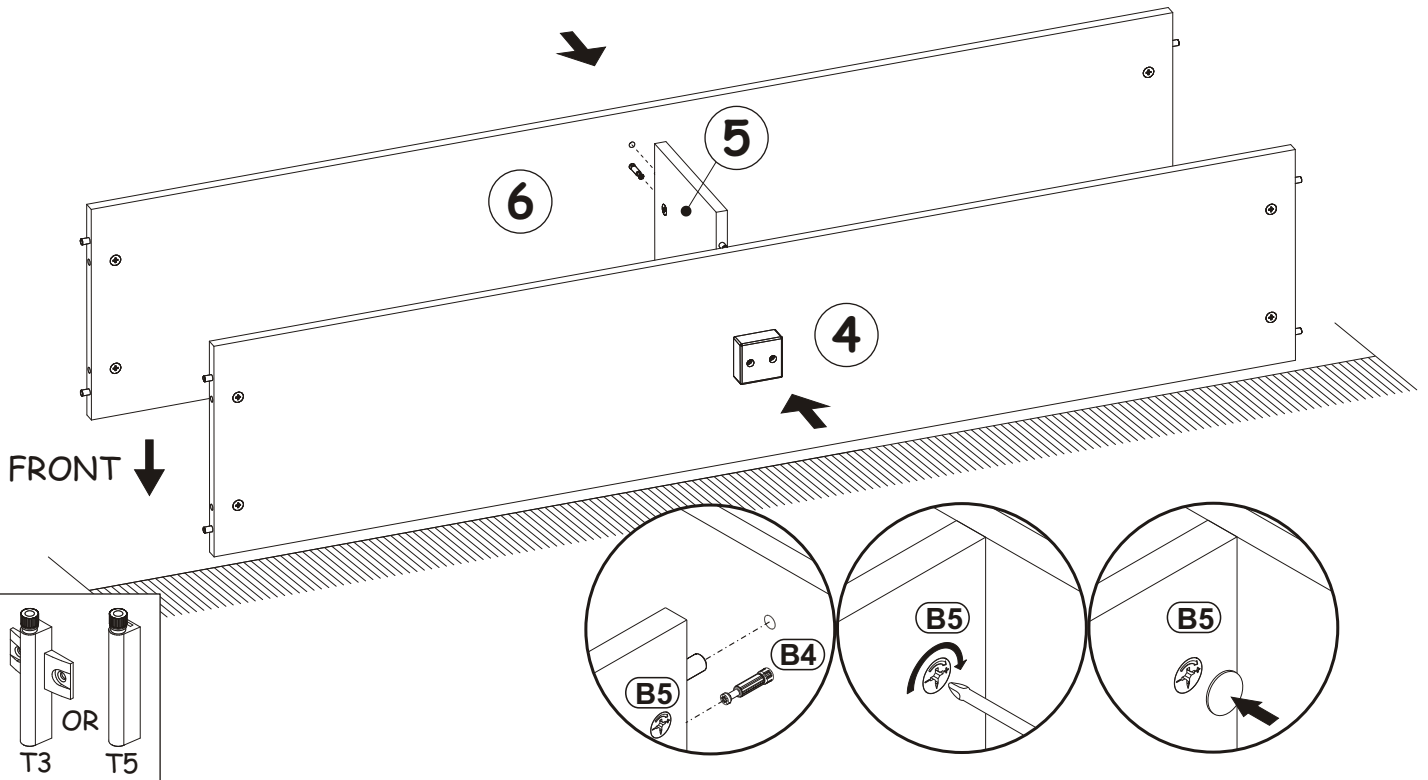

10

G5

x8

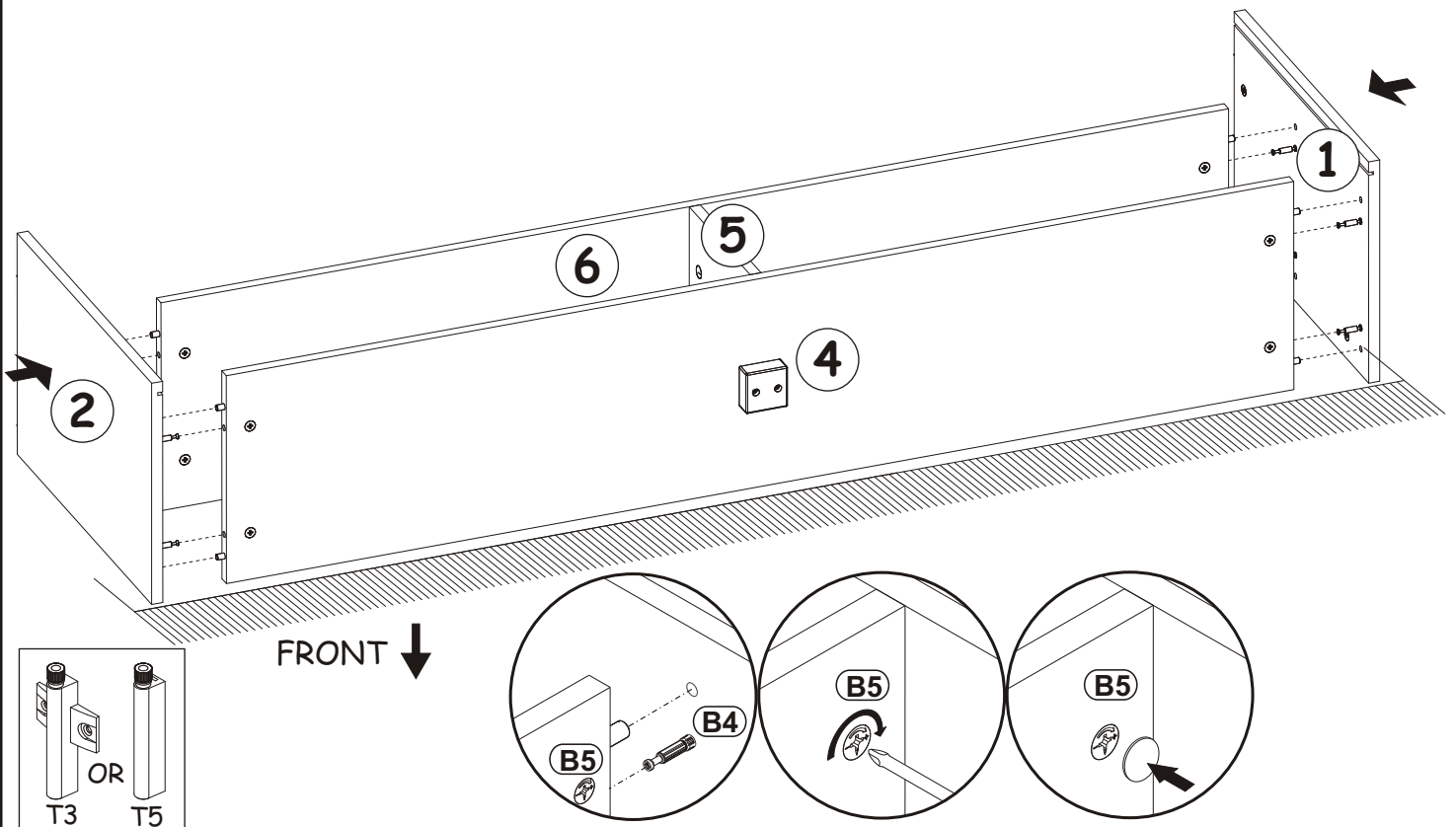

CLASSIC TV STAND

G5

x4



11

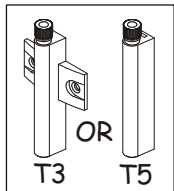
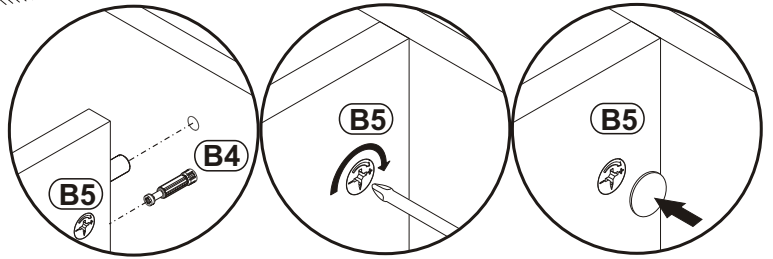
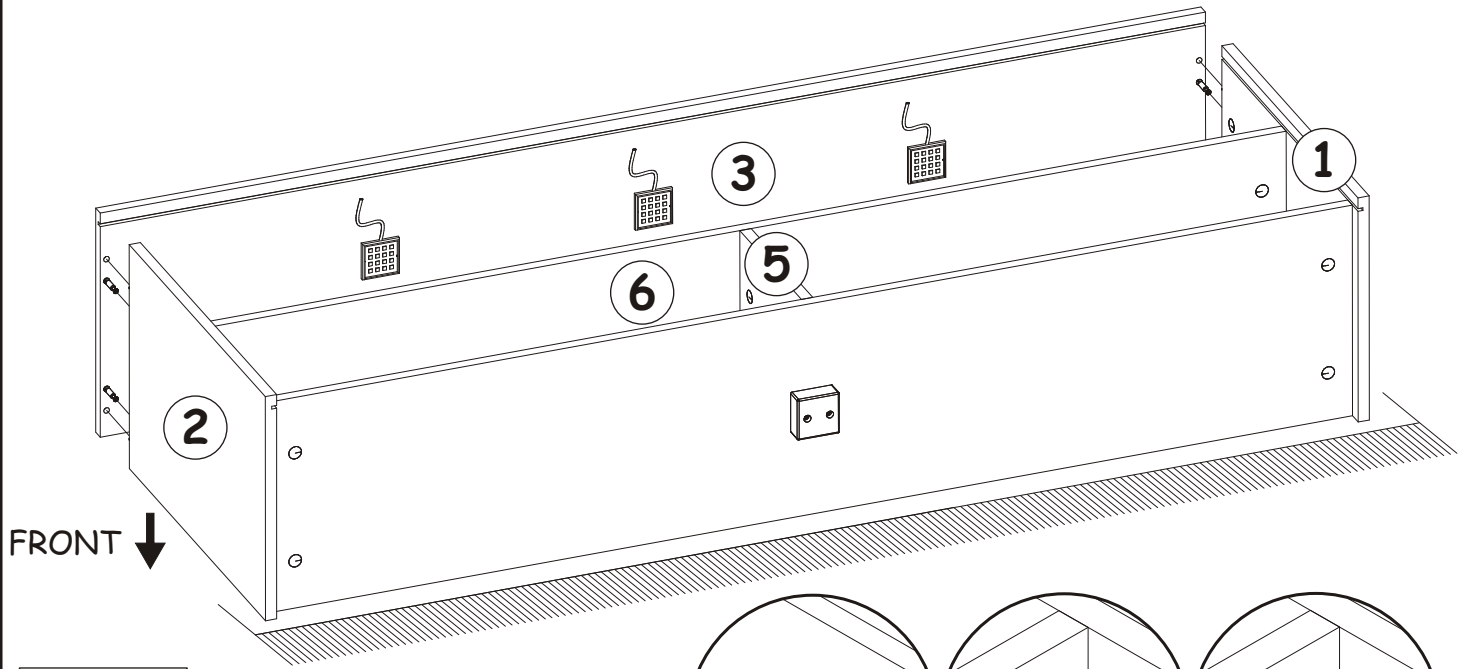

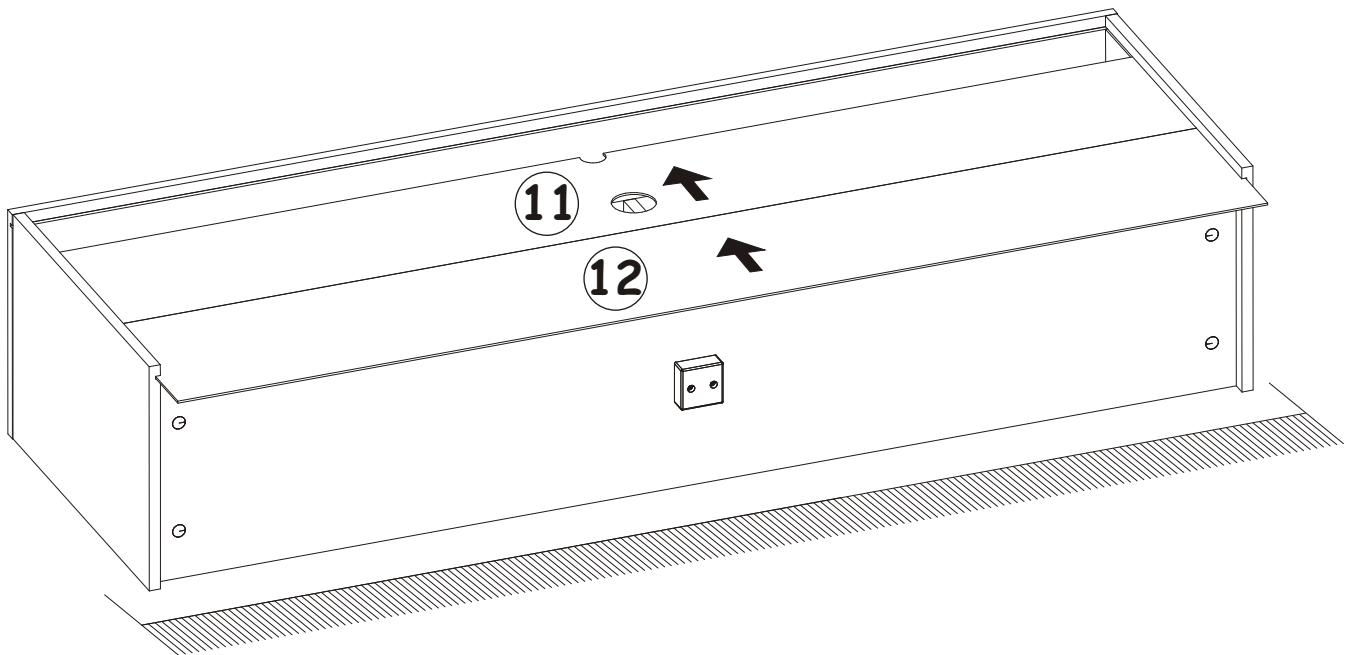

12



CLASSIC TV STAND

13

UP13	UPØ1/8"x5/8"
x18	 UPØ3x16

I2	
x4	

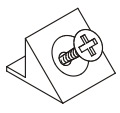
S1	
x14	

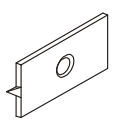
G16	
X8	

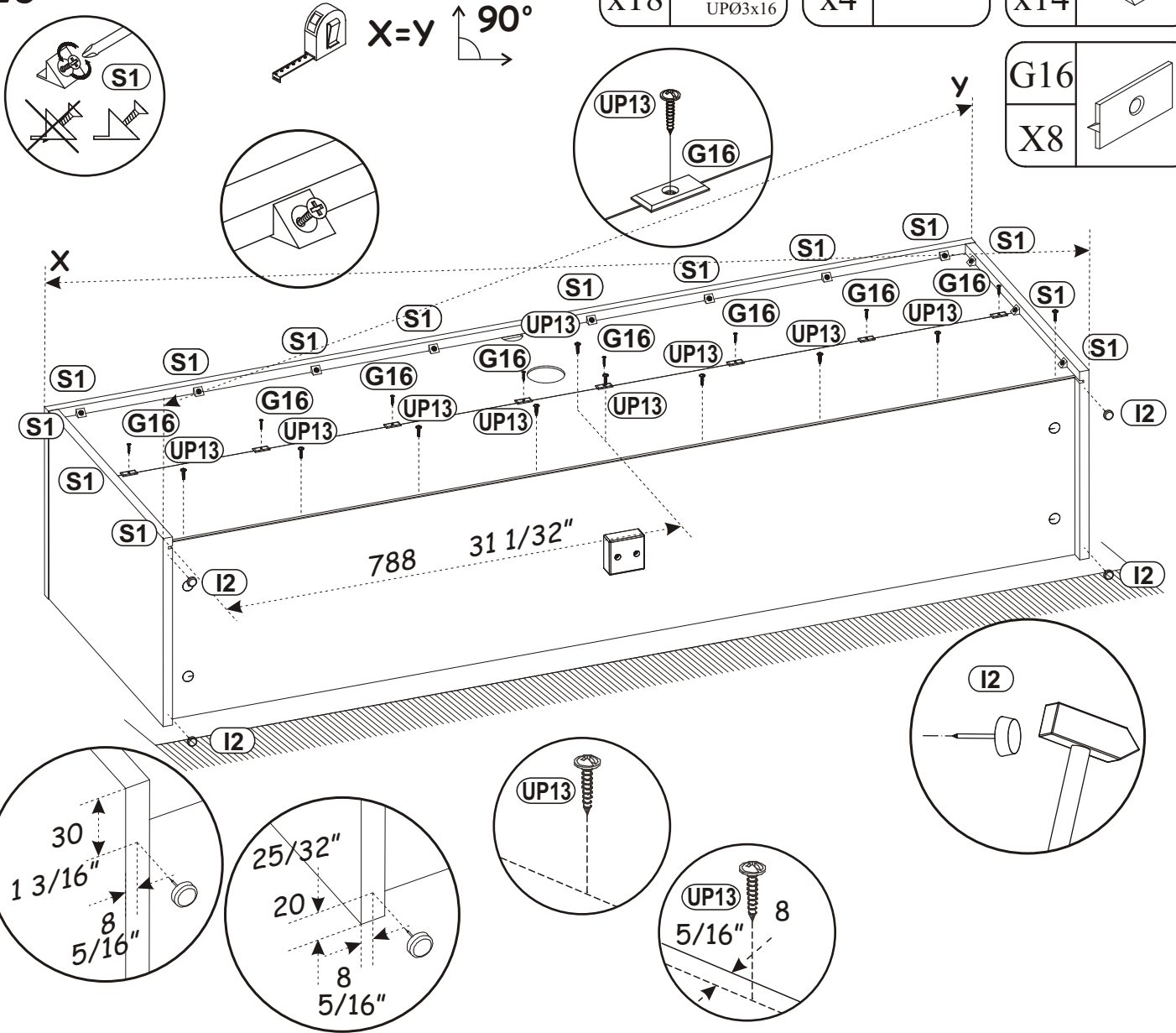

14

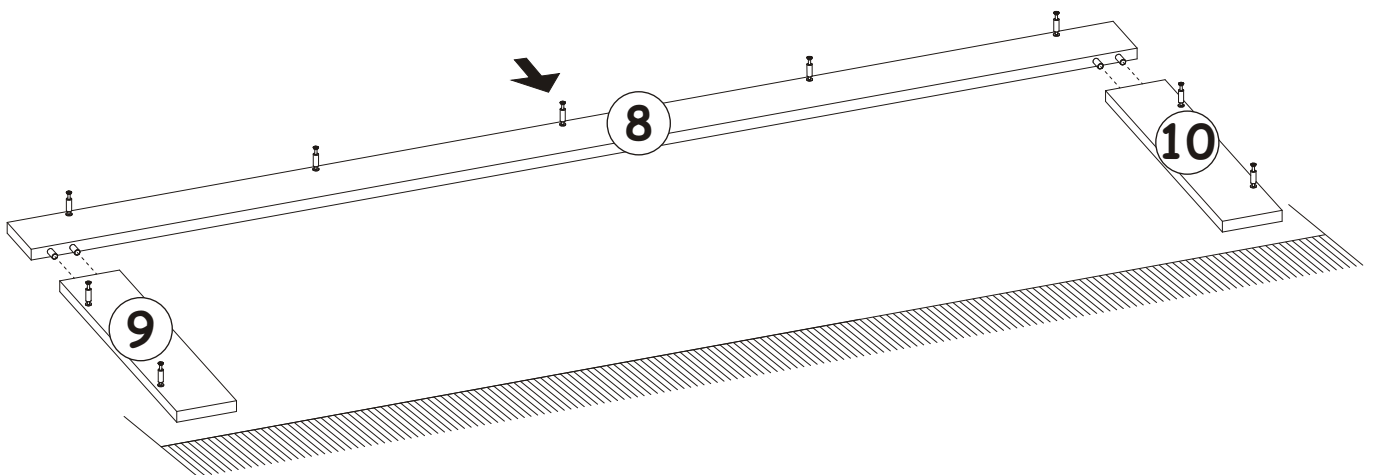

15

G5	
x9	

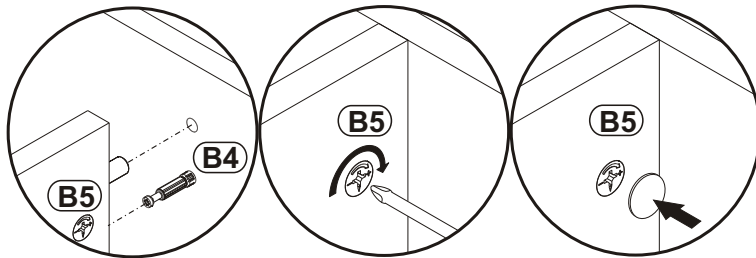
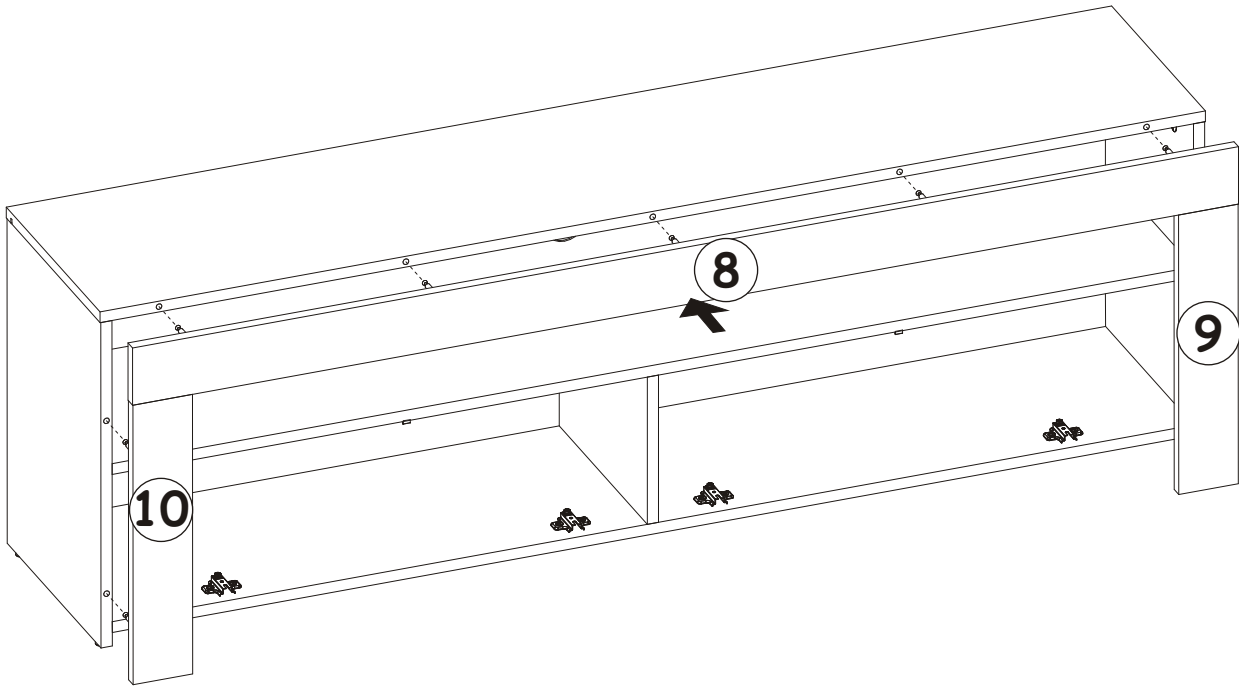

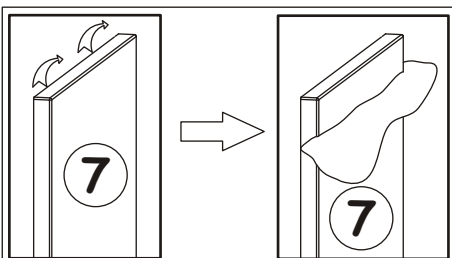
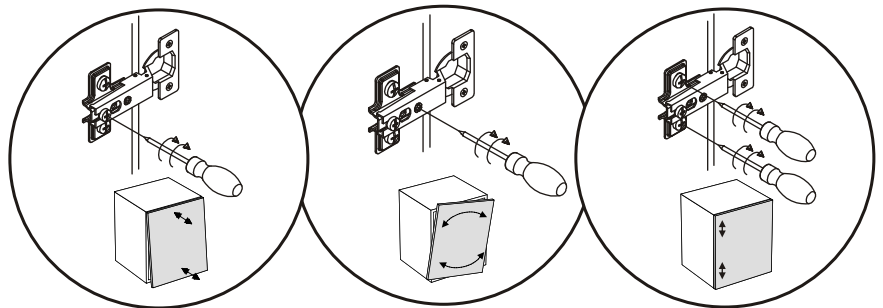
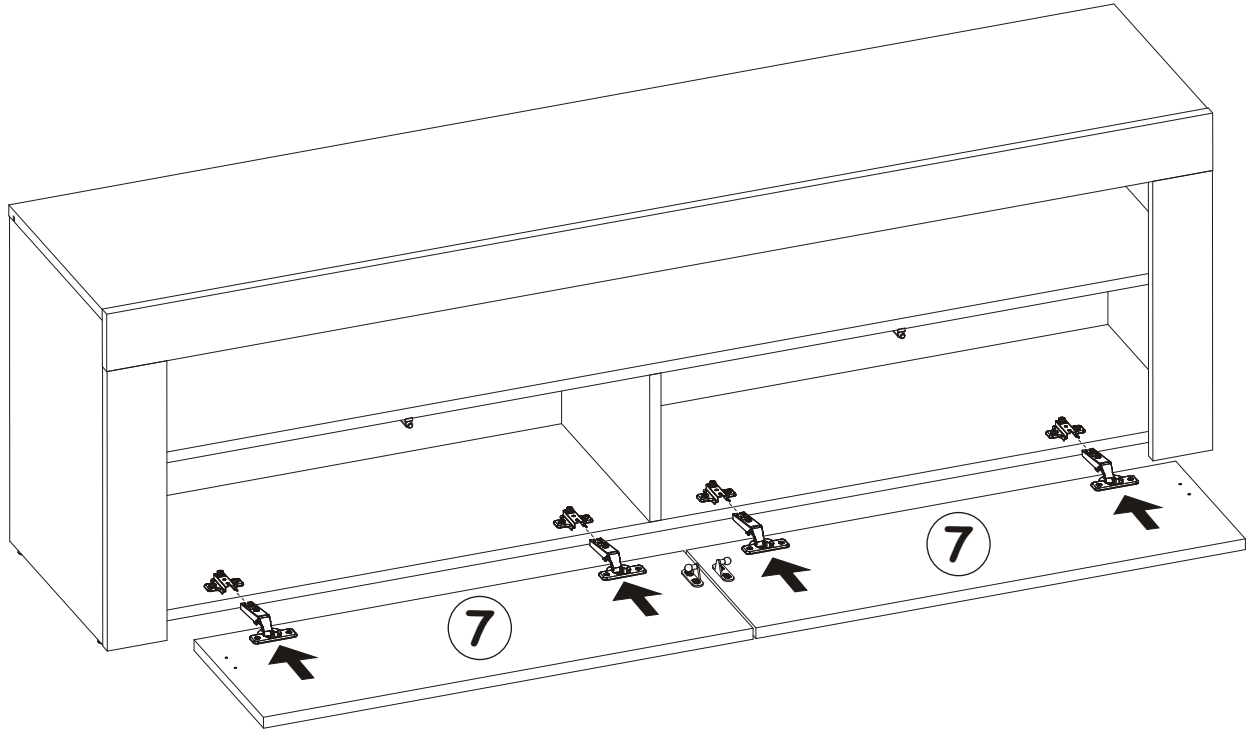
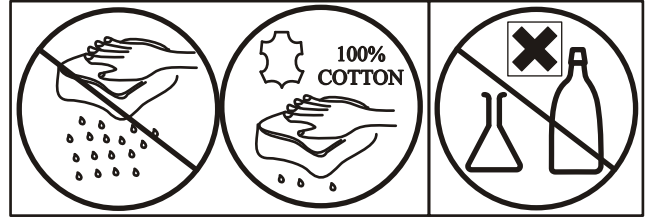

16

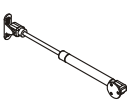

17

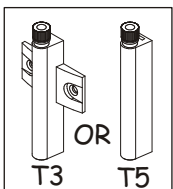
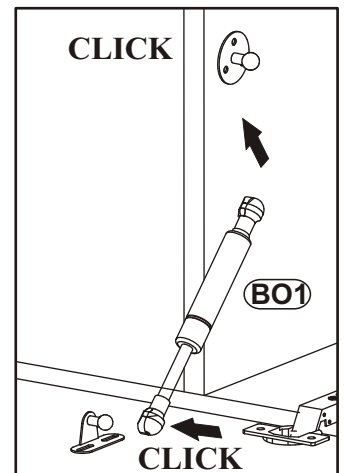
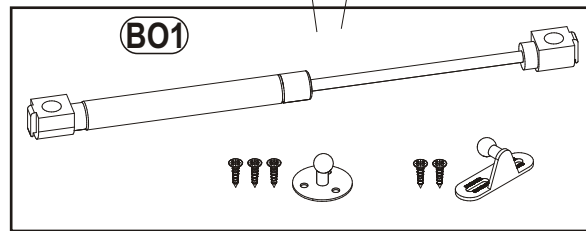
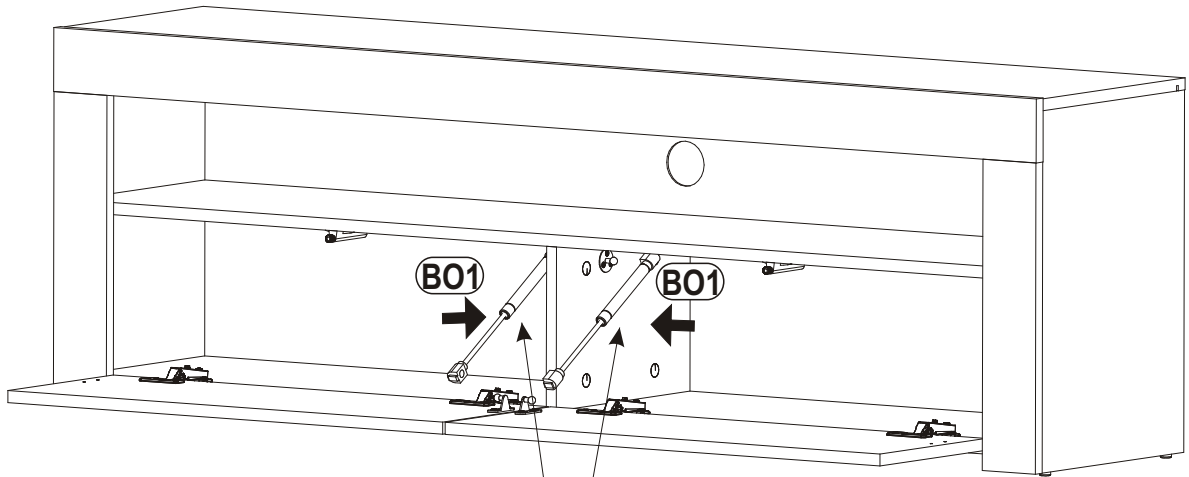
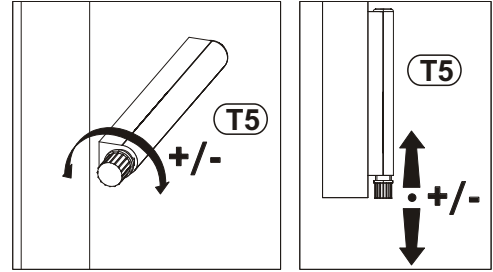
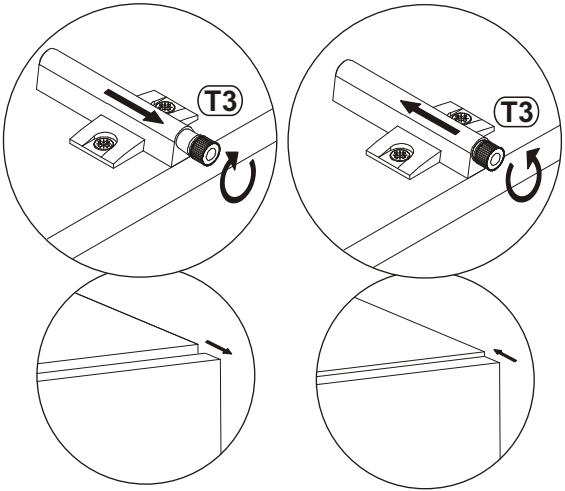
BO1	
x2	



LZ3	
x1	

