



ITEM NO.OFJX1729



Weight Capacity

300 LBS



Installation:
15 minutes.



One Person

Thank You For Choosing Our Furniture

▀ If you have any questions or concerns,
don't hesitate to reach out to us. ▀

NOTE:





This brochure contains
IMPORTANT safety info.
Please read and keep it
for future reference.

MAINTENANCE AND WARNINGS



Before You Start

Please follow the steps below:



-  Check the packaging for any damage, deformation, or water stains. If there is significant damage, please contact us promptly.
-  Unpack the box and compare the contents with the parts list and hardware list to ensure all components and accessories are present and complete.
-  Please read the installation instructions carefully to understand the installation steps and precautions to ensure proper installation.
-  Clean the installation area in advance and ensure the ground is level and there is enough space to avoid damaging the furniture or making installation difficult.
-  Lay a protective mat on the ground to prevent scratching the floor during installation.

After-Sales Service

- If you encounter any issues or need technical support during use, please contact our after-sales team. We offer long-term maintenance and warranty services.





Precautions

-  This product is for indoor use only. Do not expose it to outdoor elements or high-humidity environments.
-  Keep the product away from high heat or open flames to prevent fire hazards.
-  Do not allow children to climb on the product, as this may cause tipping and result in personal injury.



Safety Warnings

-  If you notice any loose or damaged parts, stop using the product immediately and contact customer service.
-  Do not attempt to disassemble or replace any components yourself, as this may affect the stability and safety of the product.

Daily Maintenance

- Regularly clean the surface with a soft cloth to prevent dust accumulation.
- Do not use cleaning agents containing acids, alkalis, or corrosive substances, as they may damage the surface. It is recommended to use neutral cleaning agents or specialized furniture cleaners.
- Avoid exposing furniture to humid environments for extended periods. Use a dehumidifier or desiccant during humid weather.
- Avoid direct contact of furniture with water. If water is accidentally spilled, wipe it dry immediately.
- Avoid placing excessively heavy objects on the furniture: ensure the weight is within a reasonable load-bearing range.
- Avoid using sharp or rough items on the furniture surface to prevent scratches. Handle items gently when moving them.

Explosive view

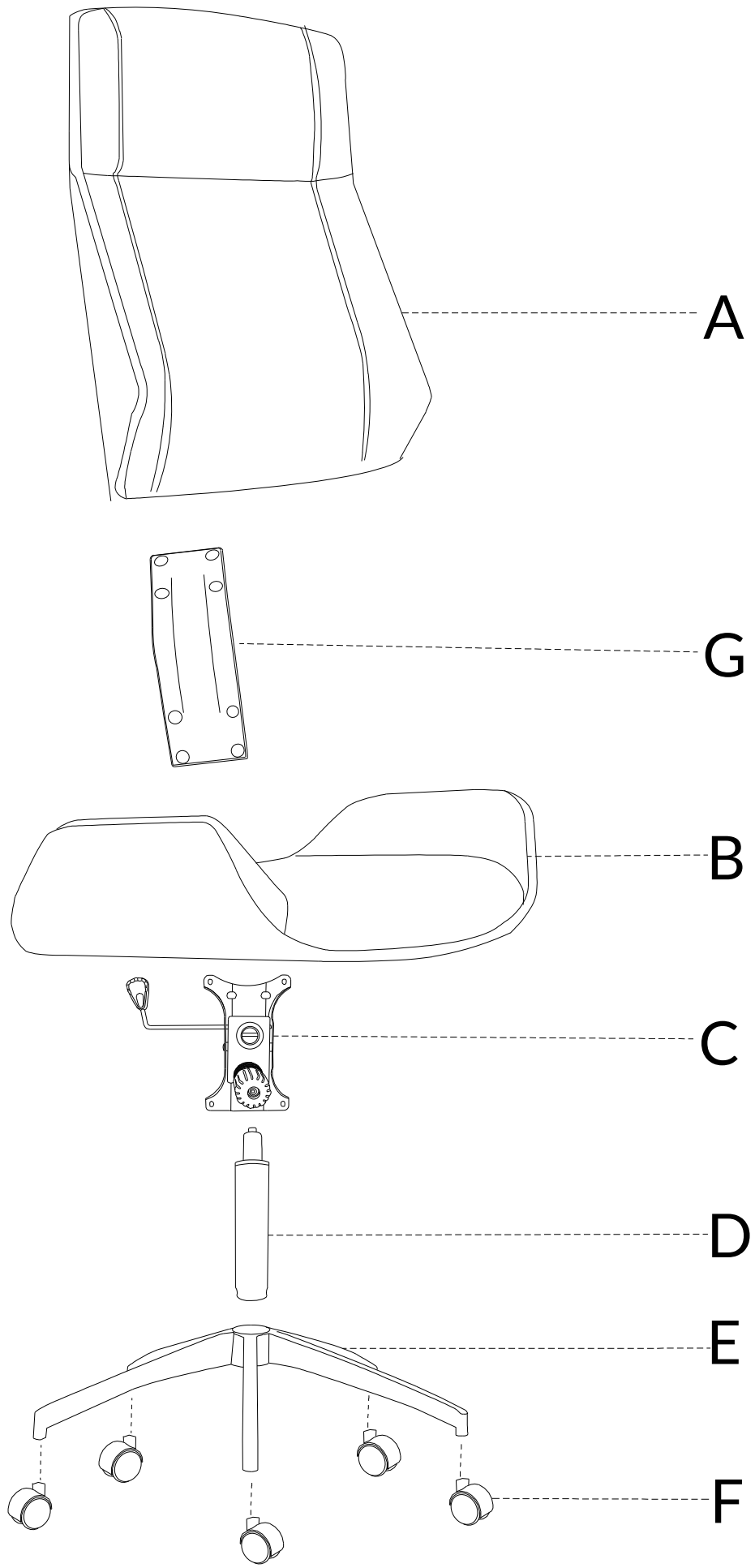

Parts list

A x1 Back

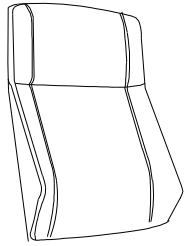

B x1 Cushion

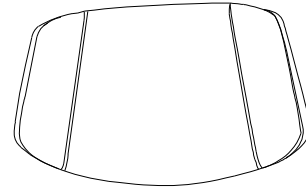

C x1 Regulator

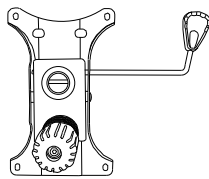

D x1 Gas lift

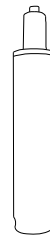

E x1 Legs

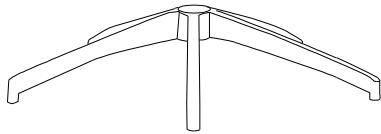

F x5 Wheels

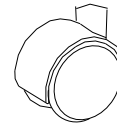

G x1 Connecting rod

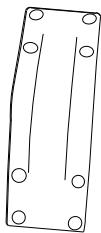

Hardware List

Hx4+1 Screw

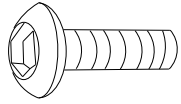

M6X18mm

lx8+1 Screw

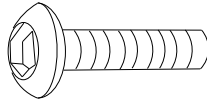

M6X25mm

Jx1 Wrench

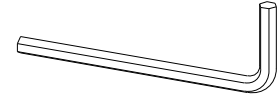

M6

Step 1

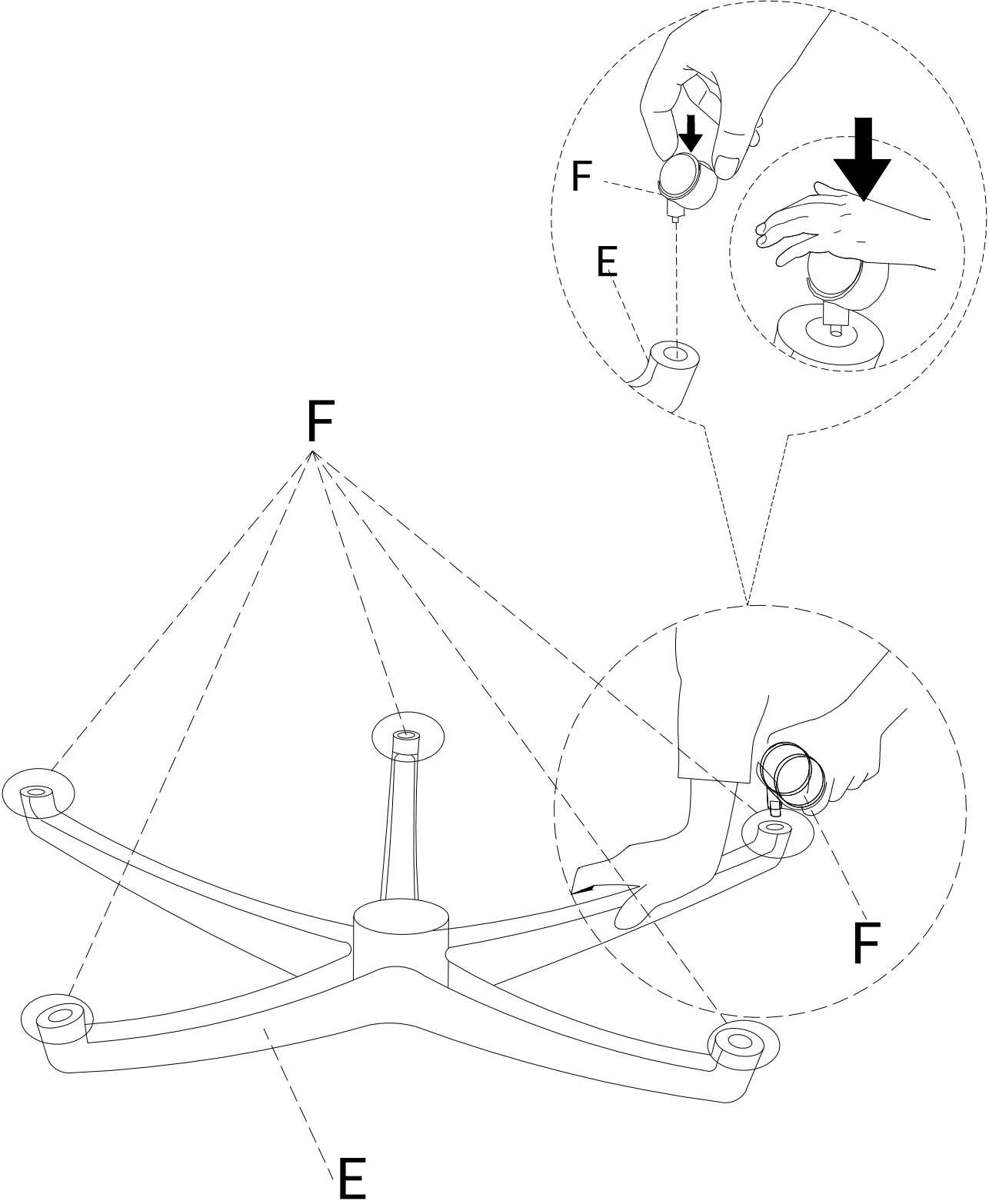

Step 2

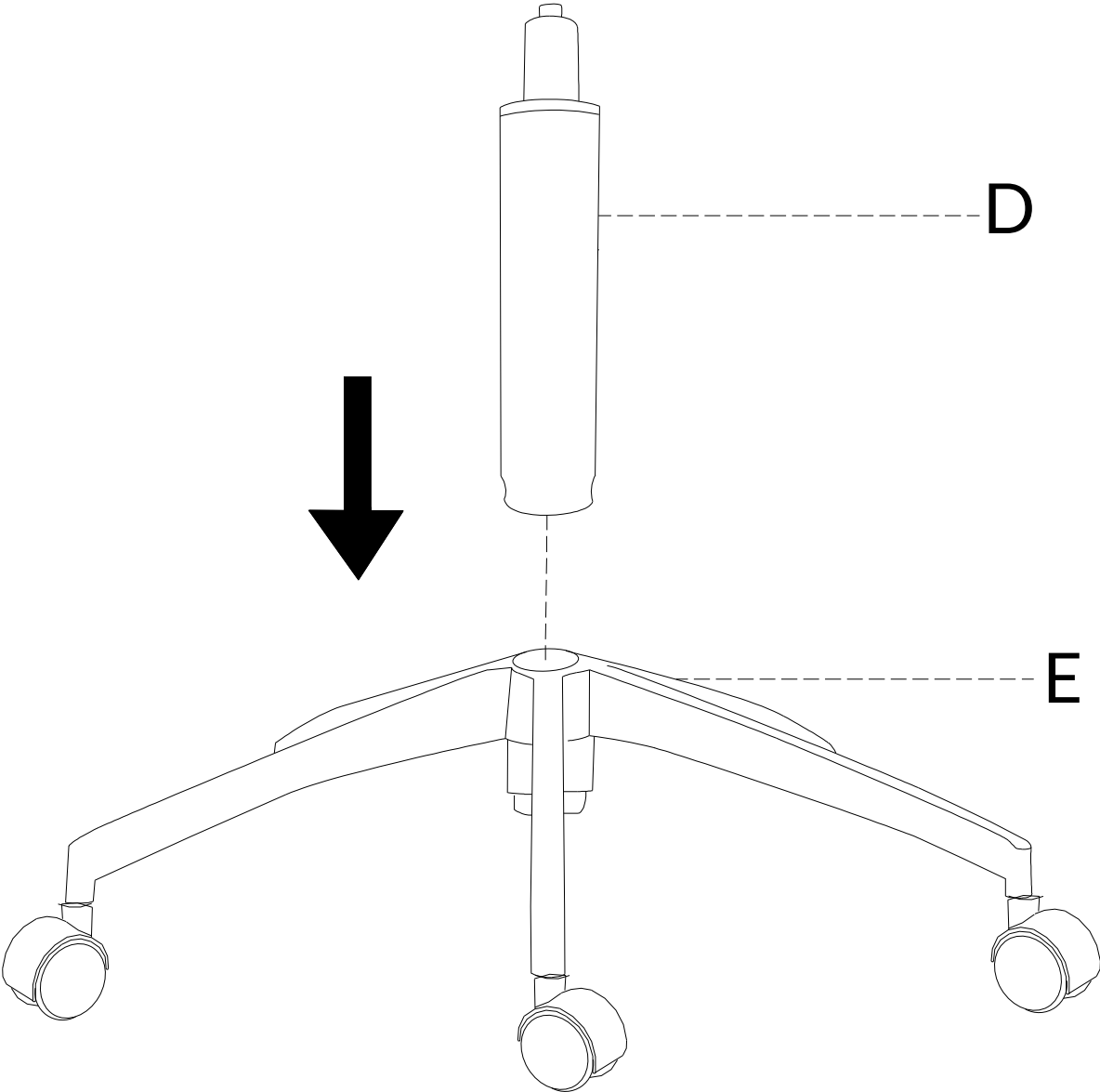

Step 3

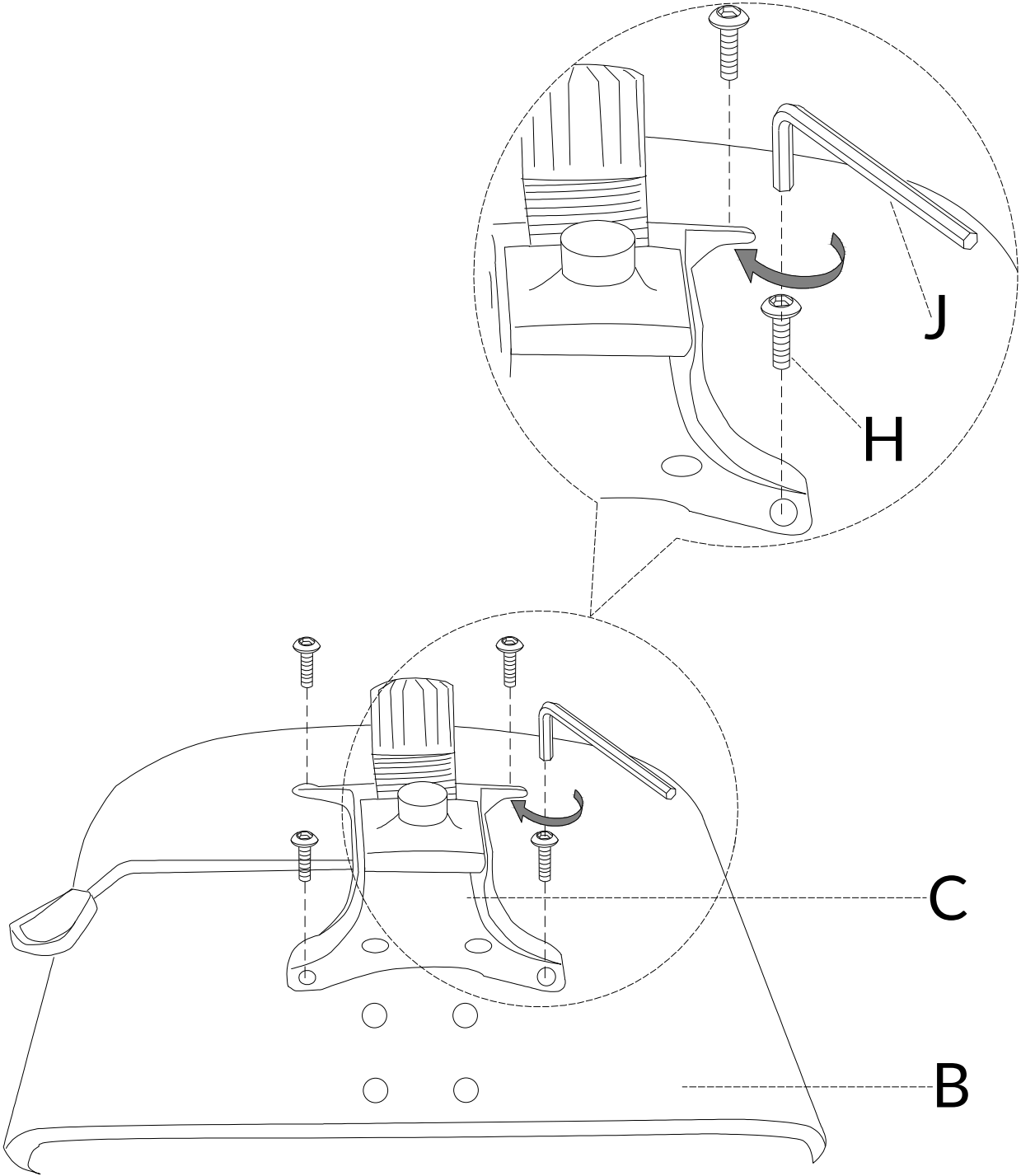

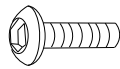
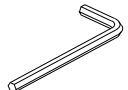
Hx4	Jx1
	
M6X18mm	

Step 4

!
The long side of the connecting iron "G" faces the backrest.

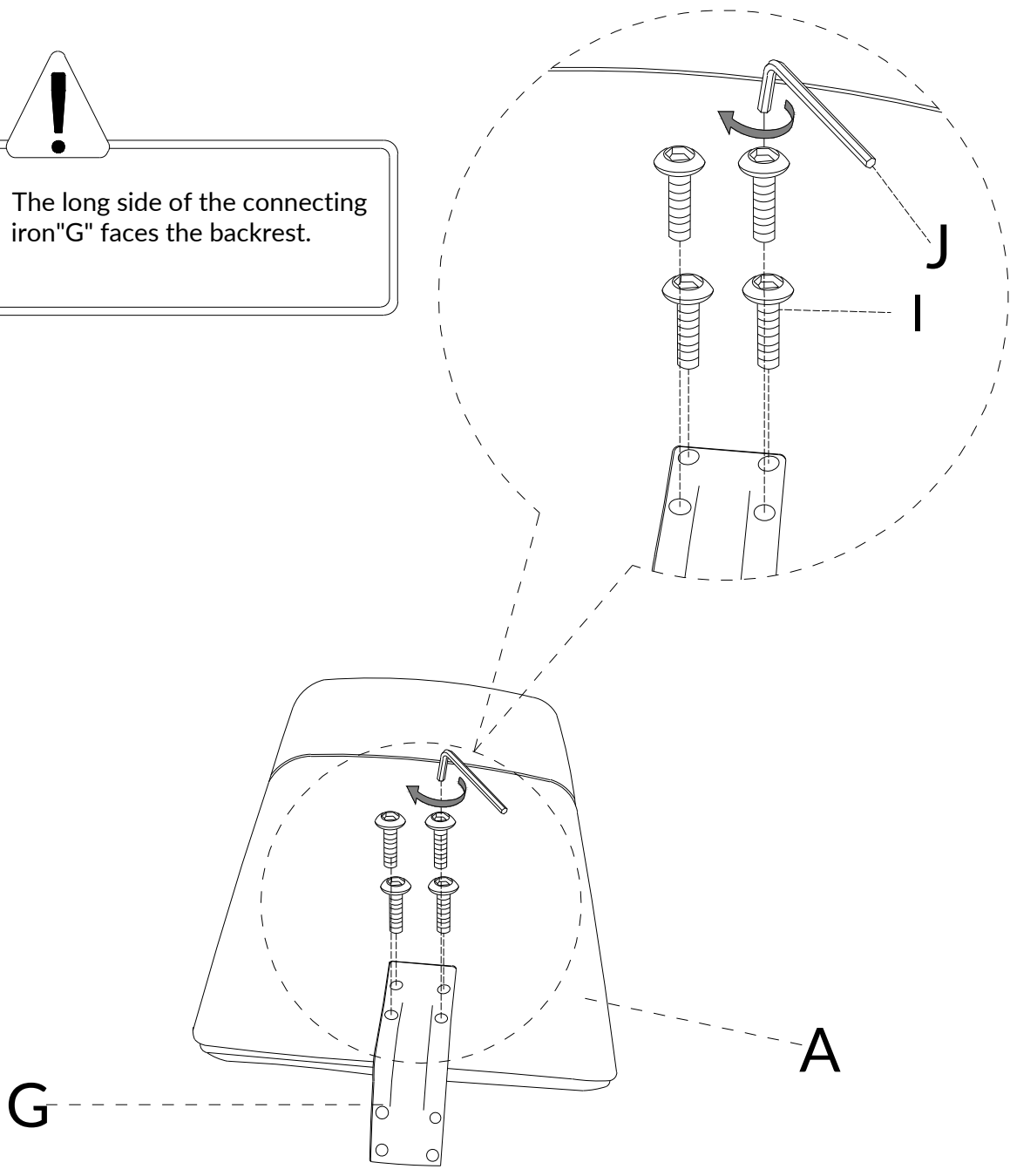

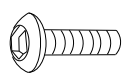
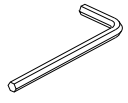
Ix4	Jx1
	
M6X25mm	

Step 5



The long side of the connecting iron "G" faces the backrest, and the short side faces the seat cushion.

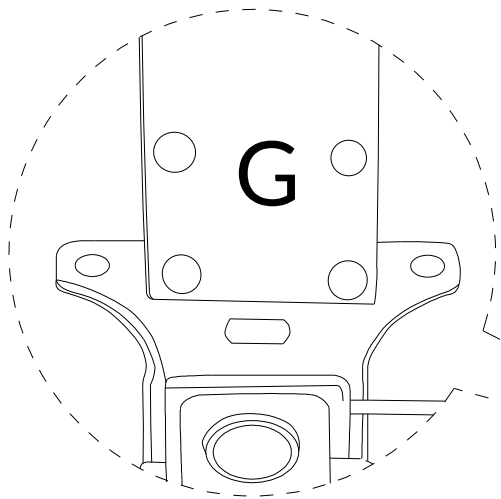
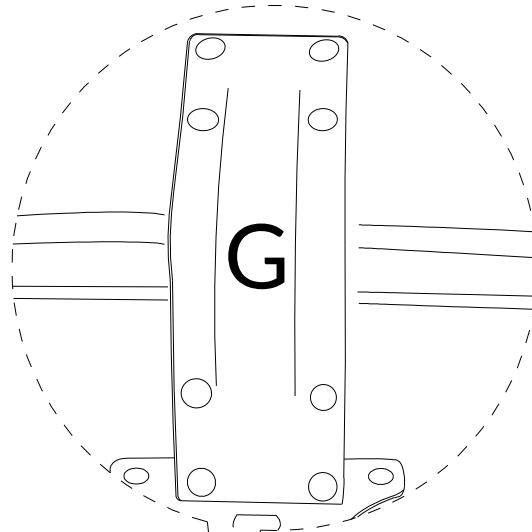

G

J

I

C



Press the steel plate onto the pallet

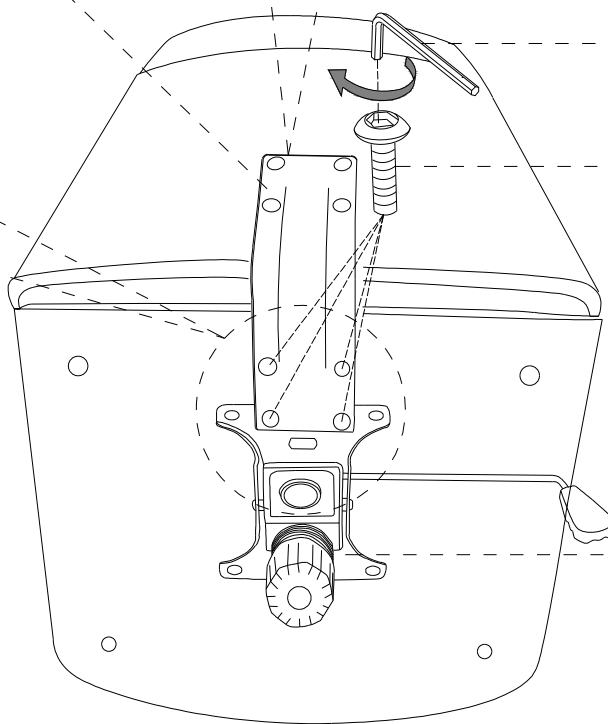

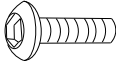
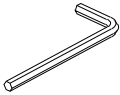
Ix4	Jx1
	
M6X25mm	

Step 6



Loosen the screws to adjust the backrest if it is not straight after putting it together

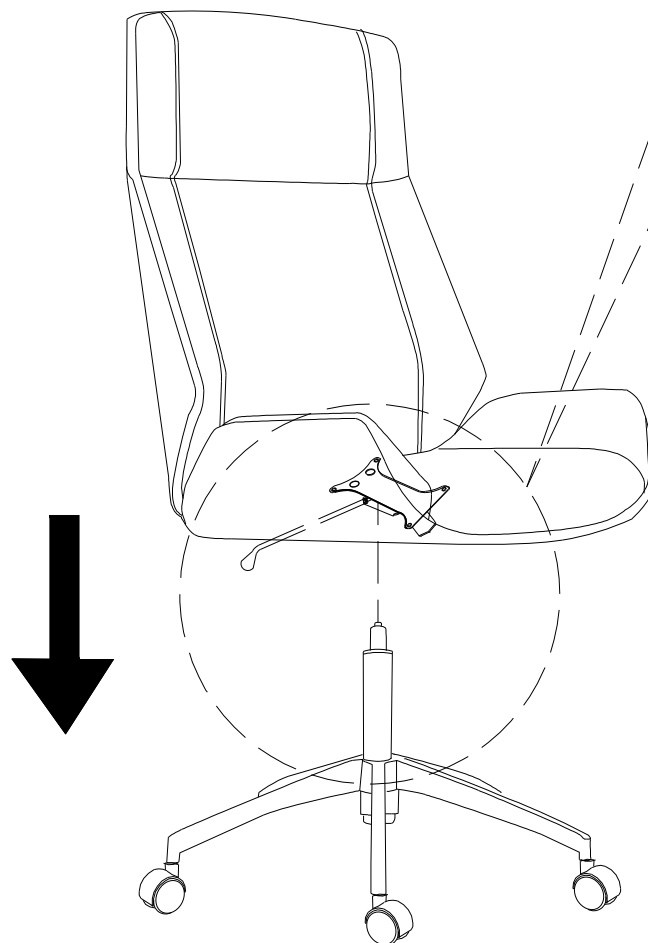
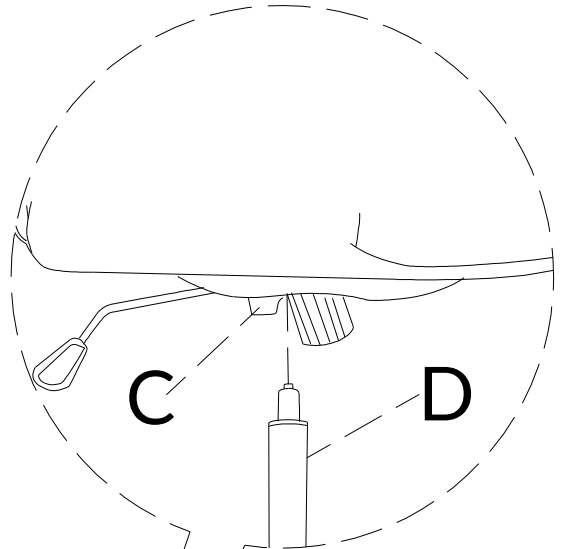
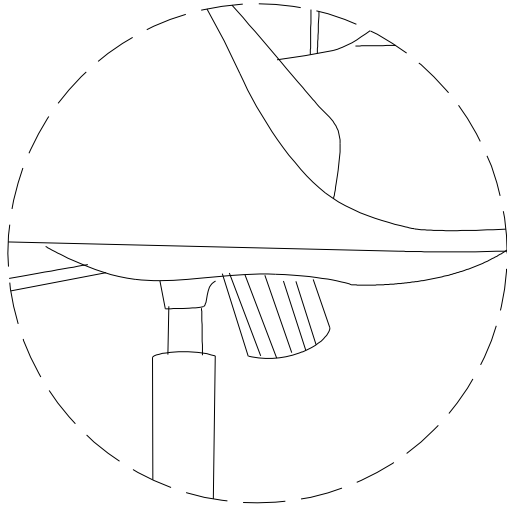

Step 7

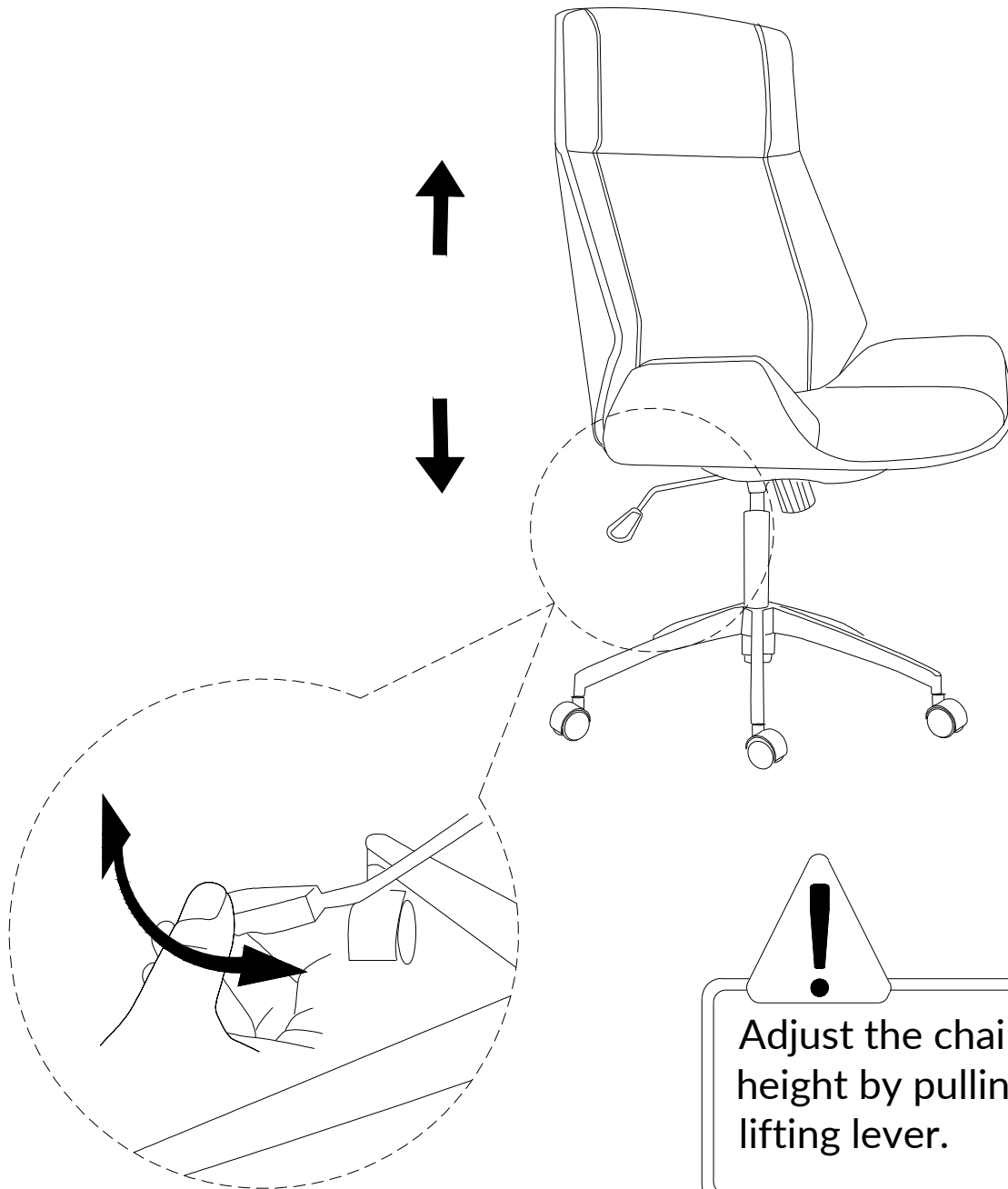

!
Adjust the chair height by pulling lifting lever.

Step 8

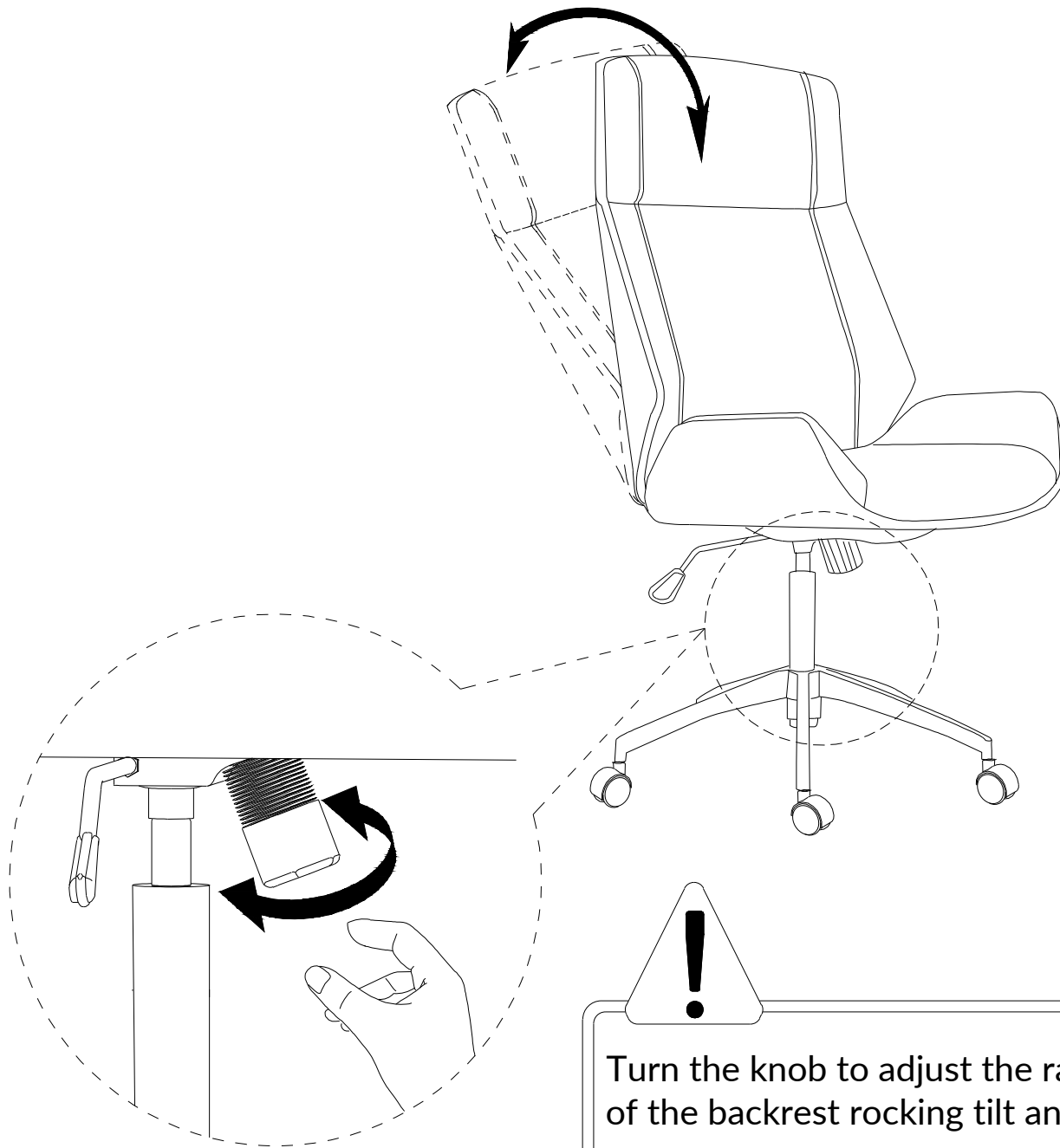

Turn the knob to adjust the range of the backrest rocking tilt angle.

Step 9

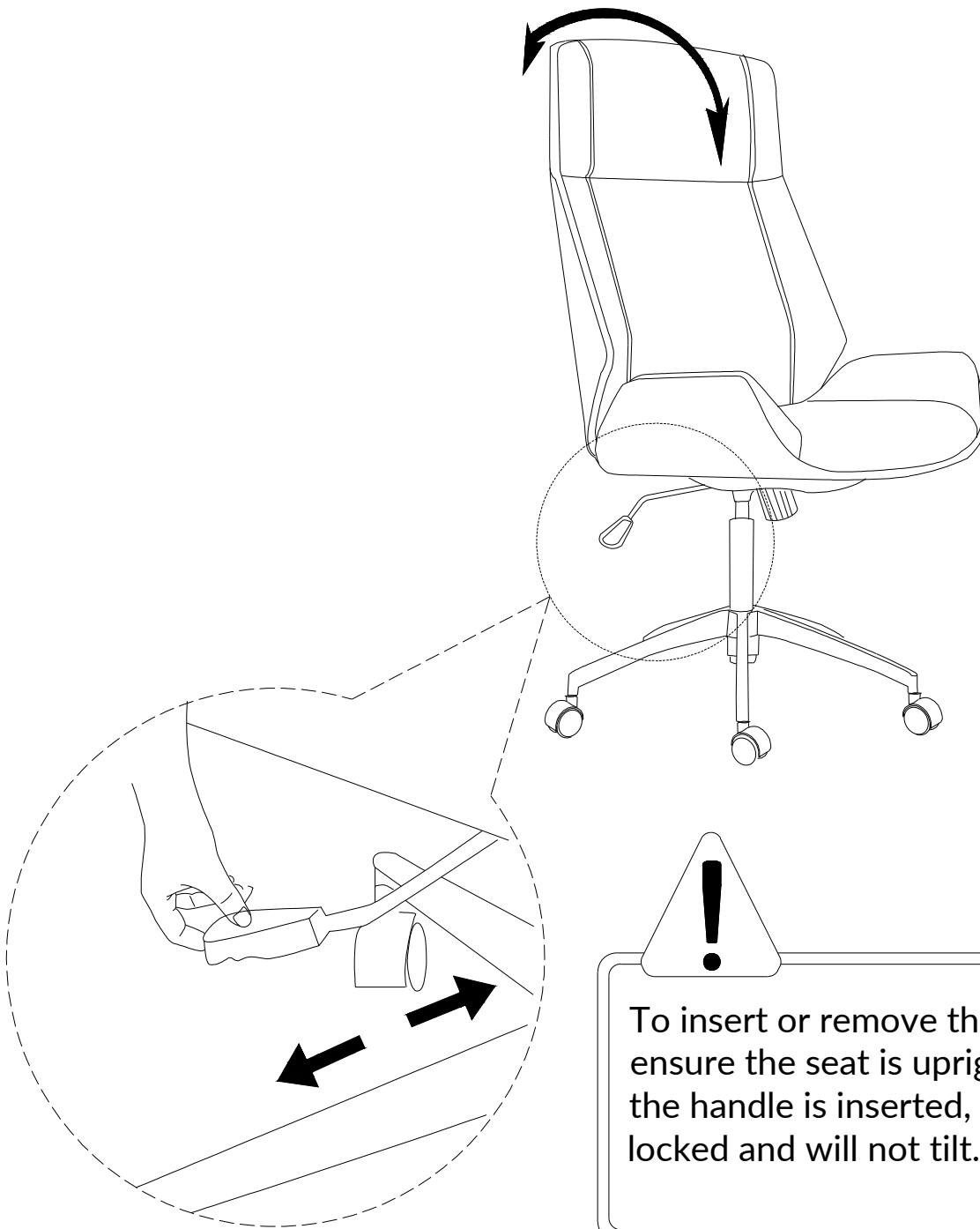

To insert or remove the handle, ensure the seat is upright. When the handle is inserted, the seat is locked and will not tilt.

WARRANTY

- We strive to offer quality products, and we also try our best to satisfy every customer who orders from us with products or services as needed.
- Replacement parts can be purchased from our company if available.
- For returns, please check the return policy with the retailer or marketplace where you purchased the item.

We appreciate your purchase.
Brighten your life with our furniture!