

ASSEMBLY INSTRUCTIONS



SNACK TABLE

ASSEMBLY INSTRUCTIONS

ASSEMBLY TIPS:

1. Remove hardware from box and sort by size.
2. Please check to see that all hardware and parts are present prior to start of assembly.
3. Please follow attached instructions in the same sequence as numbered to assure fast & easy assembly.



WARNING!

1. Don't attempt to repair or modify parts that are broken or defective. Please contact the store immediately.
2. This product is for home use only and not intended for commercial establishments.

ASSEMBLY TIME 20 MINUTES

PARTS IDENTIFICATION

A

TOP GLASS

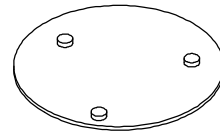

1PC

B

SUPPORT PANEL

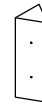

1PC

C

SUPPORT LEG



3PCS

Z

HARDWARE IDENTIFICATION

1

SCREW
(#8 x 21mm BLK)



6PCS

3

CAP
(ϕ 10mm)



6PCS

2

BOLT
(1/4" x 15mm BLK)



3PCS

4

ALLEN WRENCH
(4mm)



1PC

ASSEMBLY INSTRUCTIONS

STEP 1 Do not tighten until each step is completed or instructed.

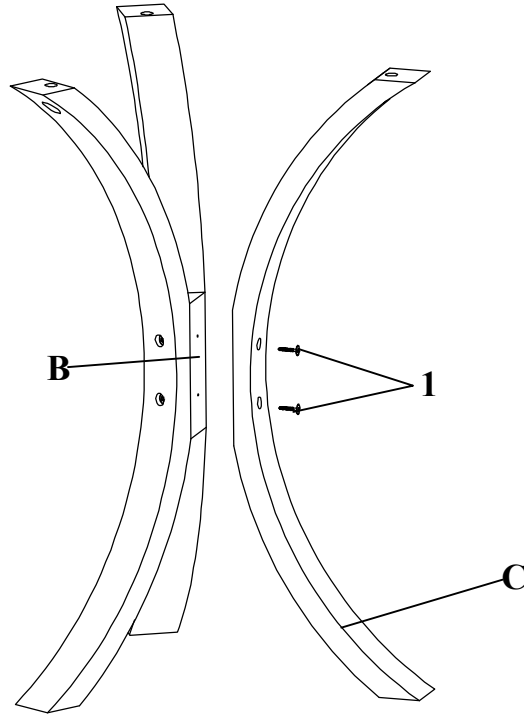

STEP 2

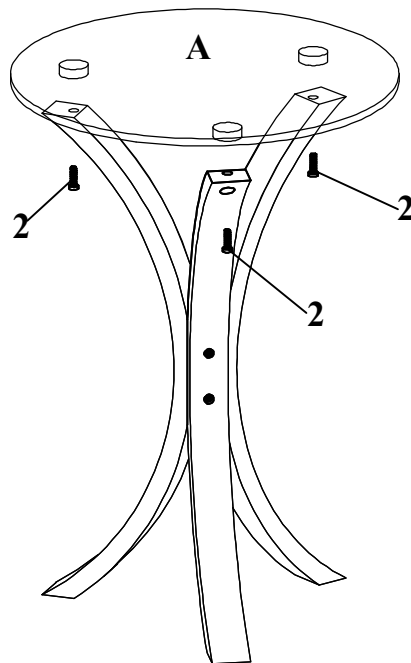

ASSEMBLY INSTRUCTIONS

STEP 3

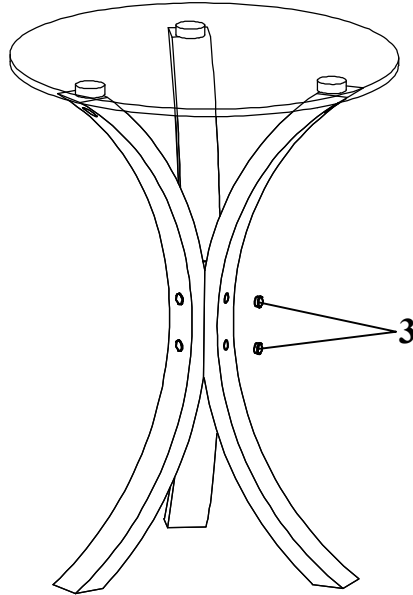

STEP 4

COMPLETE

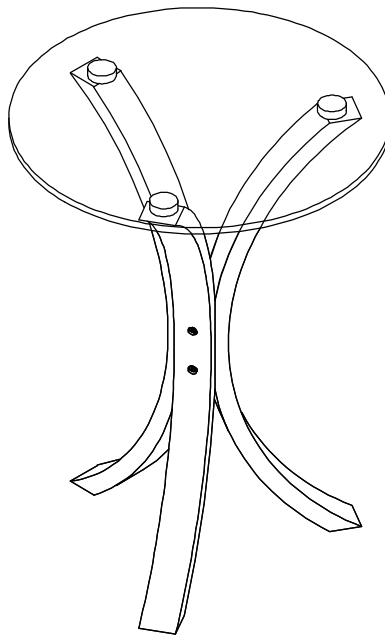

ASSEMBLY INSTRUCTIONS

Product Size : 400 DIA X 540 H (MM)

Product Size : 15 $\frac{3}{4}$ " DIA X 21 $\frac{1}{4}$ "

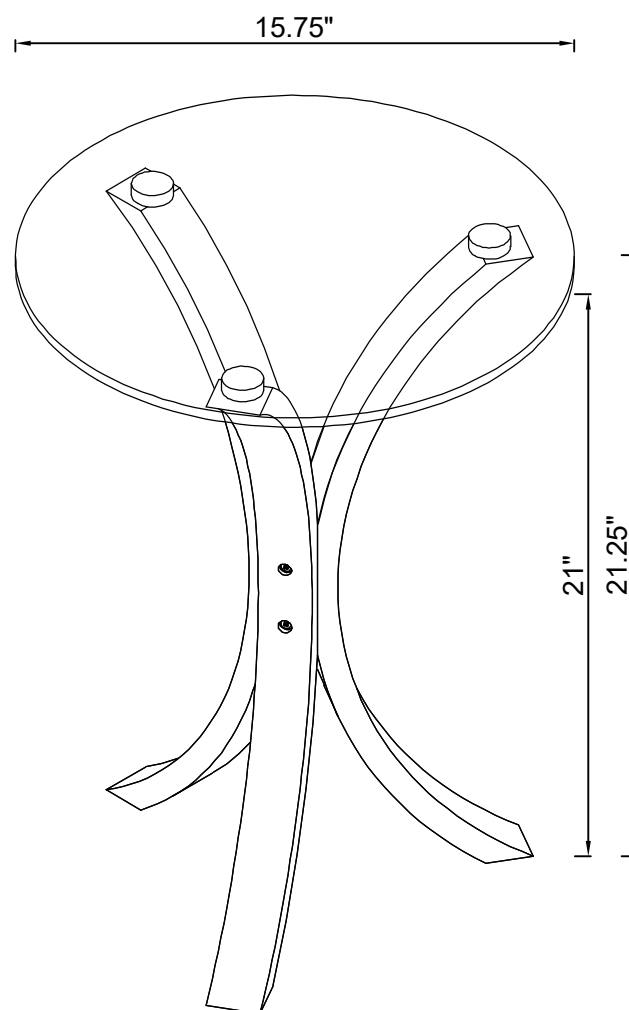

Note : Dimension tolerance $\pm 5\%$