











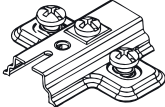
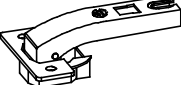
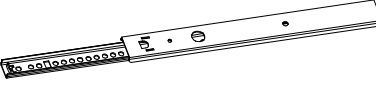





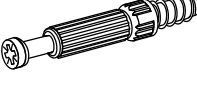
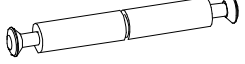

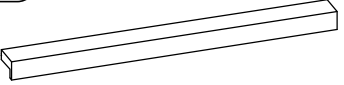

A1 8 x 35 mm x36 	A2 8 x 45 mm x4 	B0  x4
BR1  x4	T9 27/251 mm x6 	C1 4 x 13 mm x8 
C2 5 x 13 mm x12 	D2  x8	E0  x42
E1 15 x 12 mm x42 	E3 12 x 10 mm x6 	F1 6 x 34 mm x40 
F3 7 x 58 mm x4 	G0  x14	G1 7 x 50 mm x14 
H1 L-160 x5 	I2 4 x 16 mm x2 	I4 3,5 x 27mm x2 
I10 3,5 x 22 mm x8 	K1 4 x 9 mm x6 	K3 M4 x 22mm x10 
M  x1	N1 3 X 16 mm x35 	O2  x2
O3  x4	R1  x12	R4  x19
R8  x10	Q9  x2	Z  x1



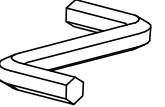

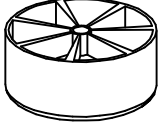
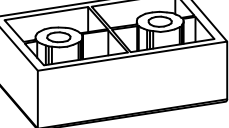
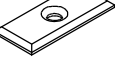
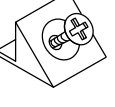
1	916	404	16	x1	2/3
2	916	404	16	x1	2/3
3	1642	404	16	x1	3/3
4	1642	404	16	x1	3/3
5	916	384	16	x1	2/3
6	916	384	16	x1	2/3
7	550	384	16	x2	1/3

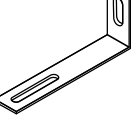
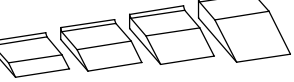
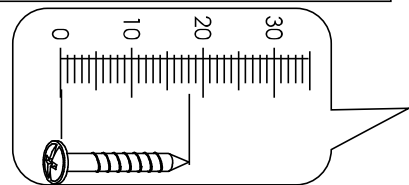
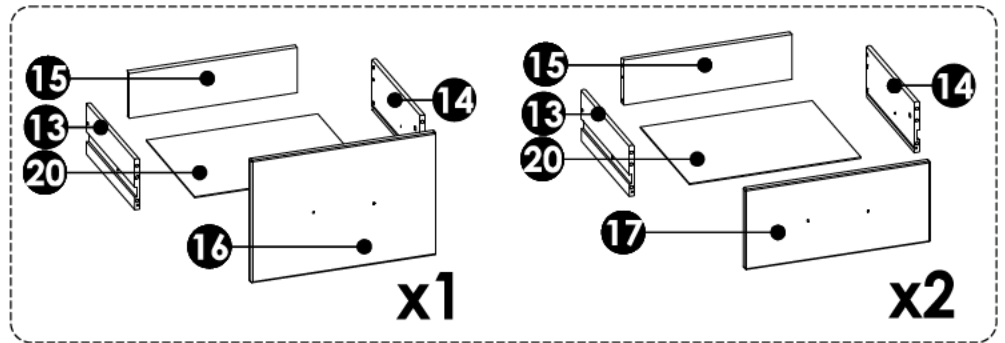
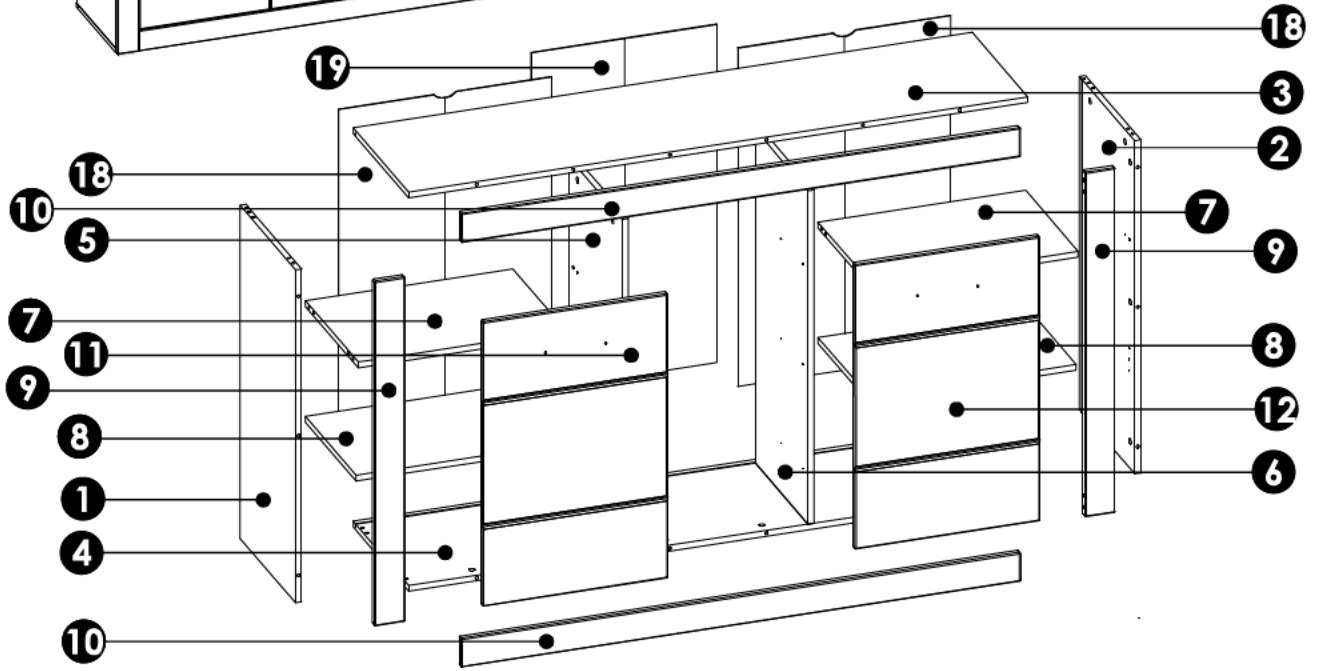
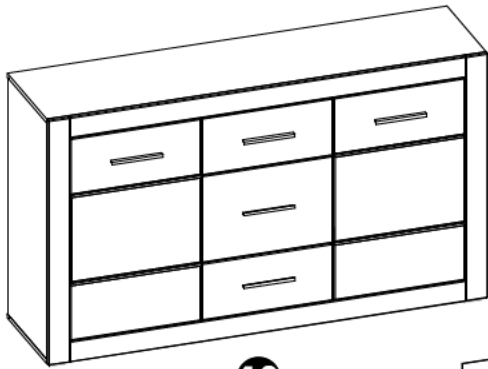
8	550	369	16	x2	1/3
9	948	80	16	x2	3/3
10	1482	80	16	x2	3/3
11	782	490	16	x1	1/3
12	782	490	16	x1	1/3
13	350	140	12	x3	3/3
14	350	140	12	x3	3/3

15	445	124	16	x3	1/3
16	490	336	16	x1	1/3
17	490	220	16	x2	1/3
18	930	564	3	x2	3/3
19	930	492	3	x1	3/3
20	455	355	3	x3	3/3