

Additional parts and accessories are available for purchase online at:
www.SevilleClassics.com



Shelf Labels



Shelving Liners
 30" x 14" (2-Pack)
 Model No.: WEB274

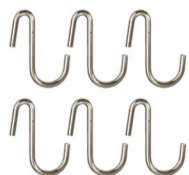

S-Hook (6-pack)
 Model No.: WEB232



Steel Wire Shelf
 30" x 14"
 Model No.: WEB370



View assembly online here:
<https://www.youtube.com/watch?v=N6iRVVqBG-I>

Caution

- Place heavier items on the lower shelves and lighter ones on the top.
- Do not stand or climb on the shelving system.
- Do not drop heavy items on the system.
- Do not move the system while loaded.

Specifications

Assembled Dimensions: 30" W x 14" D x 48" H (49.5" H on casters)

Weight capacity	Per shelf	Overall
On leveling feet	300 lbs. (136 kg)	1200 lbs. (544.3 kg)
On casters	27.5 lbs. (12.4 kg)	110 lbs. (49.9 kg)

Customer Service Information

Seville Classics, Inc
 Telephone: (800) 323-5565
 Fax: (310) 533-3899
 Hours: 8:30 AM – 4:30 PM (PST), Monday to Friday
 Email: Support@SevilleClassics.com
 Homepage: www.SevilleClassics.com

seville classics®

4-Tier Steel Wire Shelving 30" W x 14" D x 48" H (49.5" H on casters)

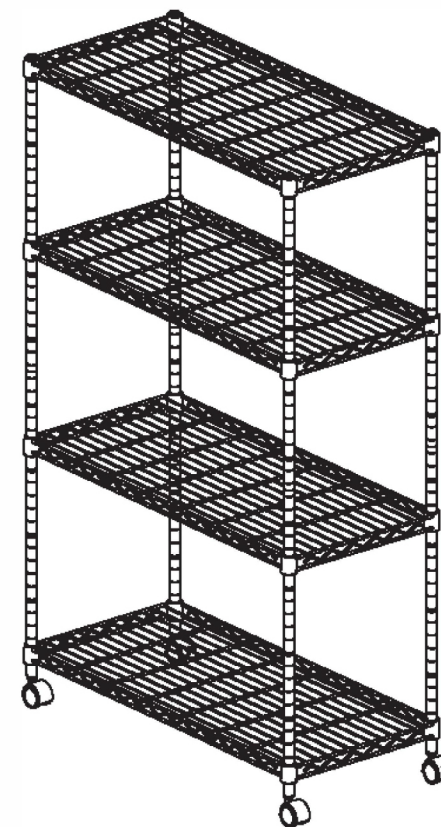





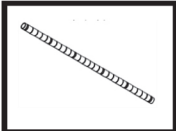

Model #: WEB674

Thank you for choosing Seville Classics! We hope that you enjoy your steel wire shelving system! Please read through this guide for parts list, assembly instructions, frequently asked questions and further contact information.

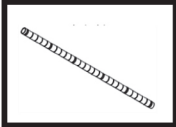
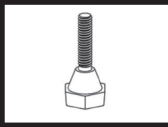
Parts List

Please make sure you have all the parts on this list.

A. Bottom poles (4) (Threaded end)		E. Slip sleeves (16)	
B. Top poles (4) (Plastic cap on end)		F. Leveling feet (4)	
C. Connectors (4) (May be attached to poles)		G. Casters (2)	
D. Shelves (4)		H. Locking Casters (2)	

If you're missing parts, contact us for replacements at (800) 323-5565 or send an email to Support@SevilleClassics.com

Assembly Instructions

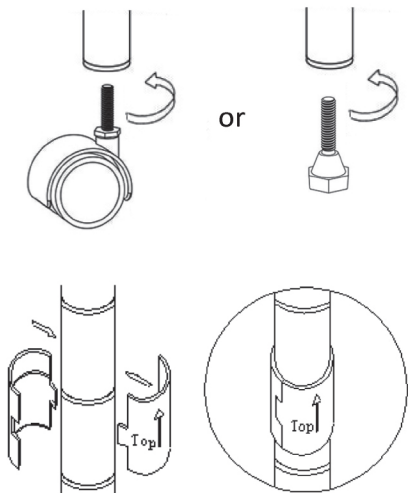

1

STEP 1.

Screw **LEVELING FEET (F)** or **CASTERS (G, H)** into base of bottom poles.

Repeat for all bottom poles.

STEP 2.

Snap **SLIP SLEEVES (E)** around the grooves on **BOTTOM POLES (A)** for your lowest shelf.

TIP! Count the number of grooves from the bottom of the pole to keep the height consistent.

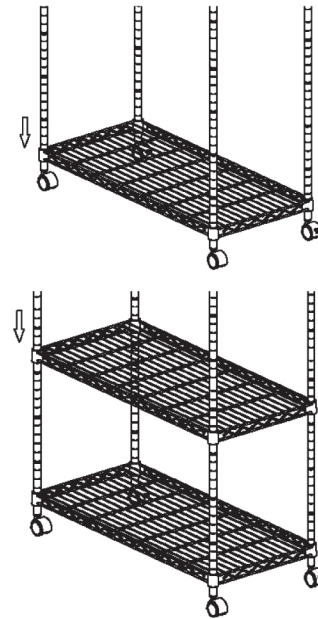

STEP 3.

Fit **SHELF (D)** over the top of the 4 poles and over **SLIP SLEEVES (E)**.

Repeat **STEPS 2-3** for next shelf.

TIP! If necessary, lightly tap shelves into place with a rubber mallet.

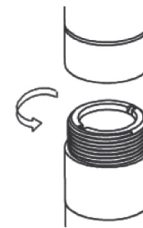

STEP 4.

Screw **CONNECTORS (C)** into top of **BOTTOM POLES (A)**.

Screw **TOP POLES (B)** to **CONNECTORS (C)**.

TIP! Connectors may be pre-installed.

STEP 5.

Repeat **STEPS 2-3** for remaining shelves.

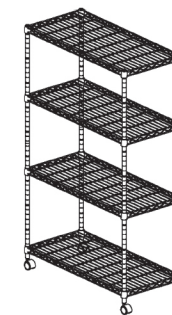
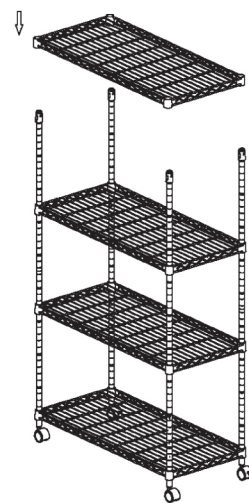

Congratulations!

Enjoy your now complete shelving unit.

2