

Top View

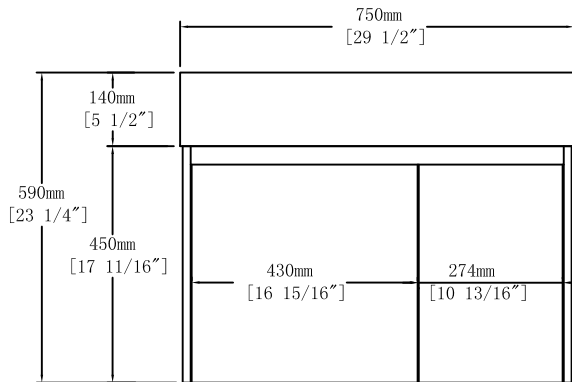

Front View

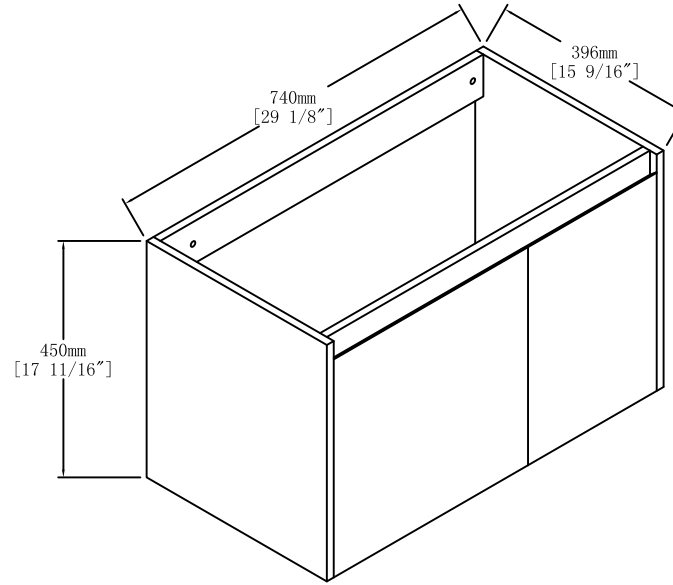
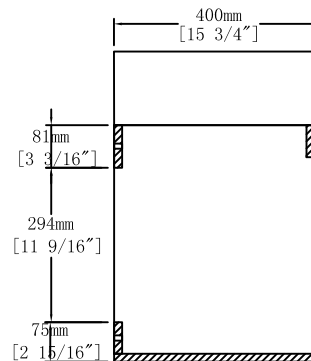

Side View

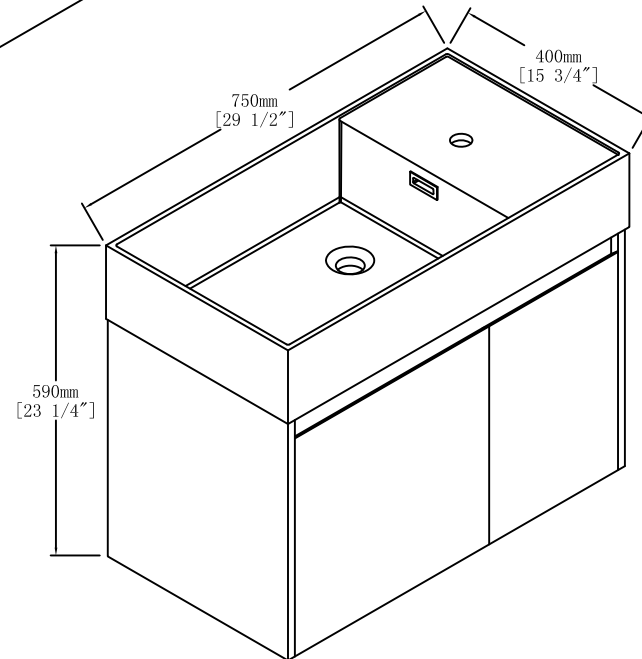

Item NO.

BV B09330

Version

V1

Project

Date

2024-6-14