

INSTRUCTION
ANWEISUNG
取扱説明書
INSTRUCTION

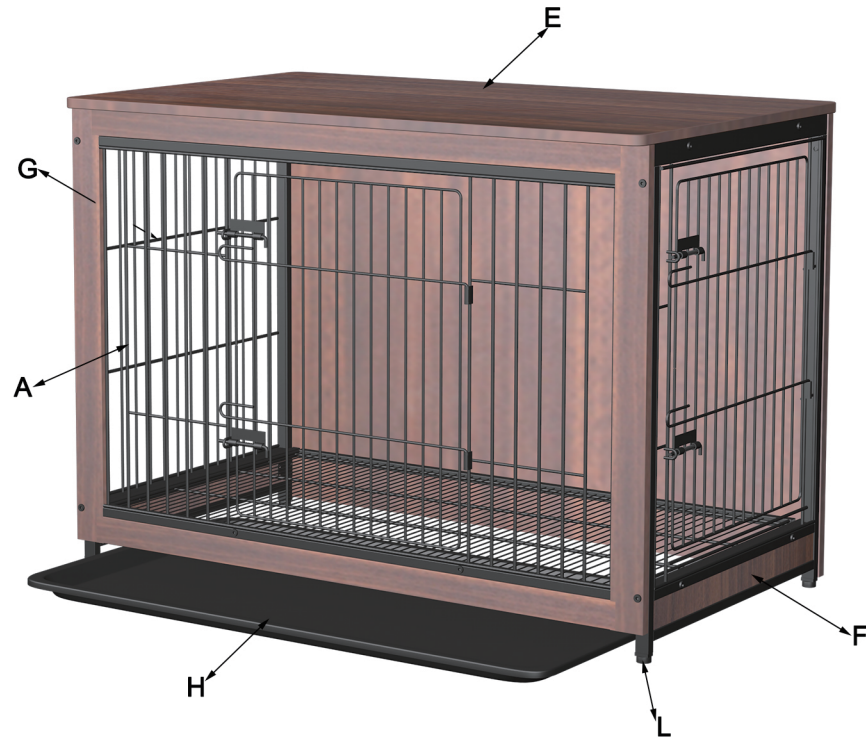

- ▶ If there are missing accessories or screws in package, please contact seller and we will send the missing parts to you for free.
- ▶ Wenn es die Schrauben oder anderes Zubehör fehlt, bitte kontaktieren Sie mit uns, wir können Ihnen es kostenlos erneut ausstellen.
- ▶ 足りない部品又は破損している部品のある場合は、当店までご連絡をお願いいたします。
- ▶ Veuillez contacter le vendeur s'il manque de vis ou d'autres accessoires, nous allons vous les envoyer gratuitement

A x1

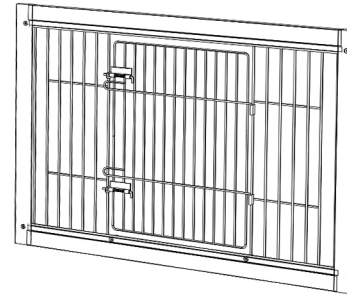

B x1

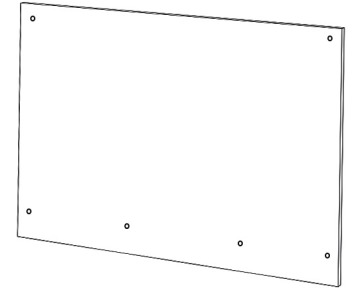

C x1

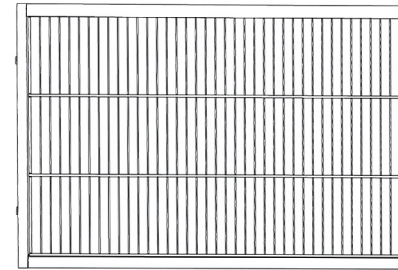

D x2



E x1

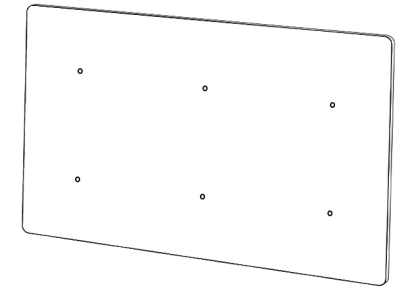

F x1

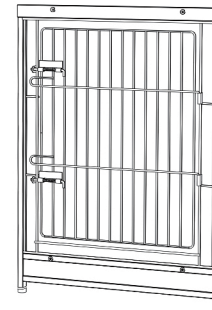

G x1



H x1

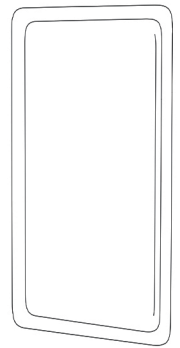

I x20
M6x25mm



J x6
M6x23mm



K x4



L x4



M x1

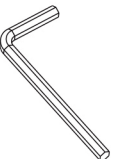

1

K x4

L x4

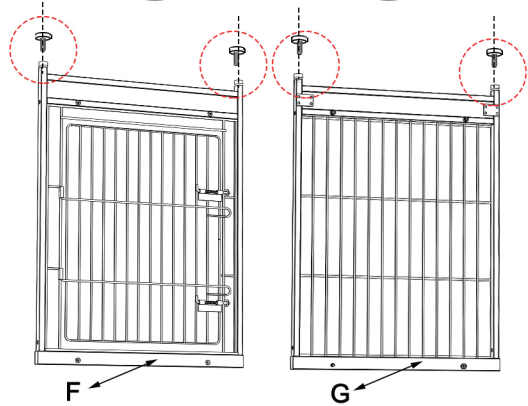
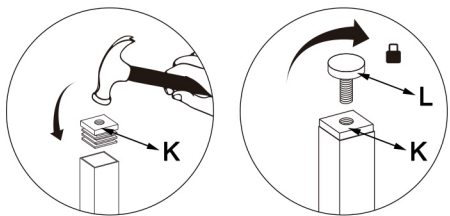
**2**

I x2

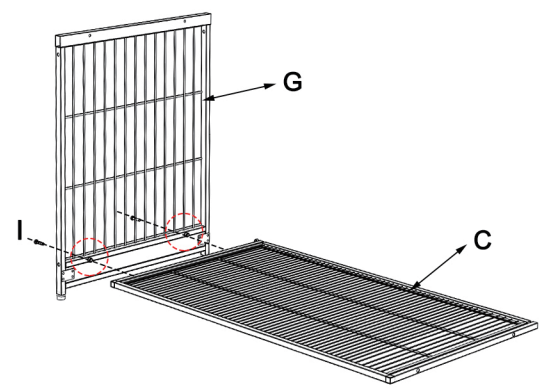
**3**

I x2

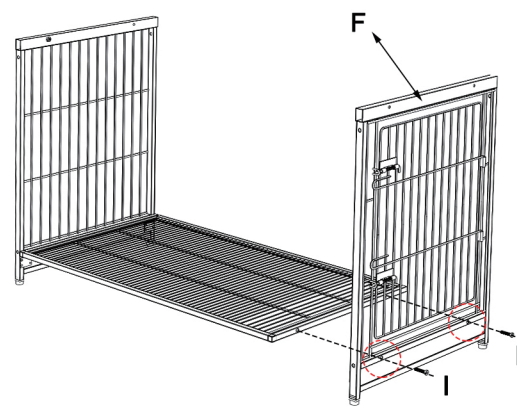
**4**

I x6

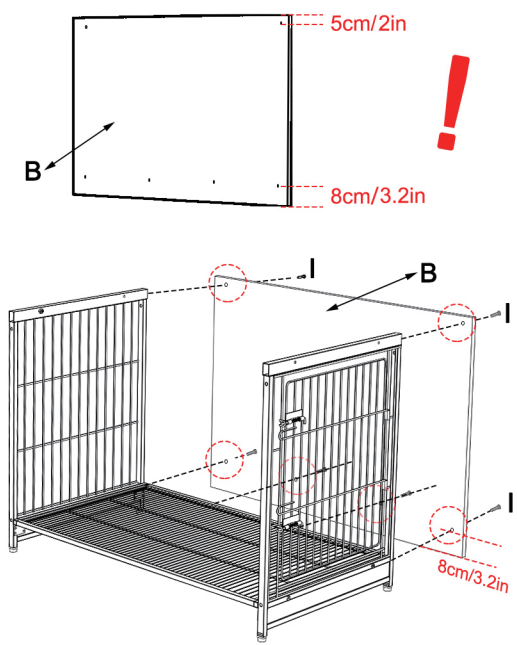
**5**

I x6

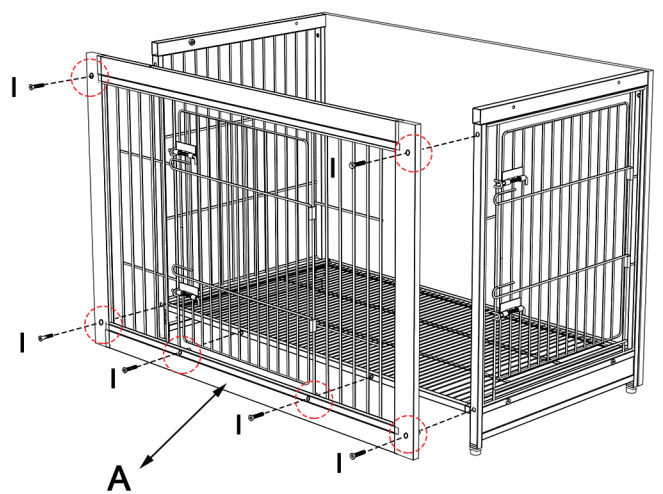
**6**

J x6

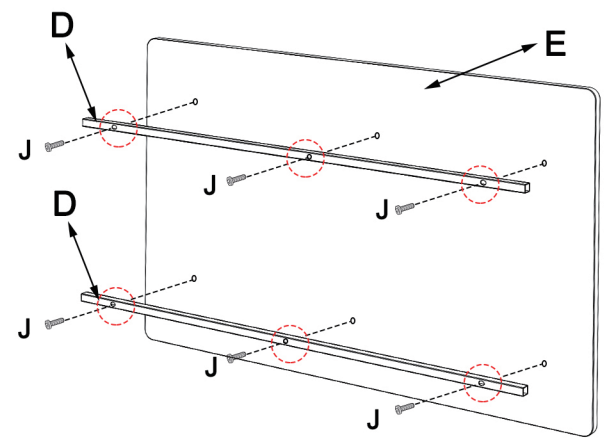
**7**

I x4

