

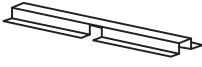

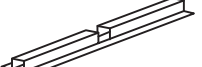







ASSEMBLY INSTRUCTIONS

UMBRELLA

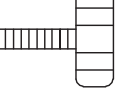
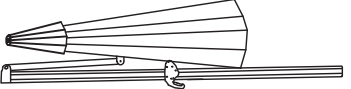
ASSEMBLY INSTRUCTION

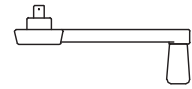
					 M8*15
A 1 PC	B 1 PC	C 1 PC	D 1 PC	E 1 PC	F 4 PCS
					
G 8 PCS	H 1 PC	I 1 PC	J 1 PC		K 1 PC
		 M8*25			
L 1 PC	M 1 PC	N 4 PC	P 1 PC		

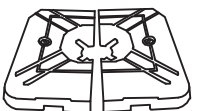
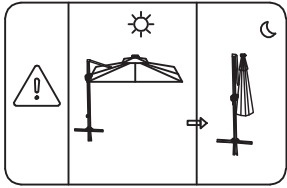
CARE INSTRUCTIONS

Outdoor furniture naturally weathers and shows color variation over time. We recommend the following care for the best results:

- Wipe with a soft cloth.
- Wash with mild soap and water as needed; do not use abrasive cleaners.
- Cover furniture with an outdoor cover (not included) when not in use.
- Store in a dry, covered area during inclement weather or winter season.



After assembly is completed, save these instructions and any included tools for future maintenance or re-assembly.

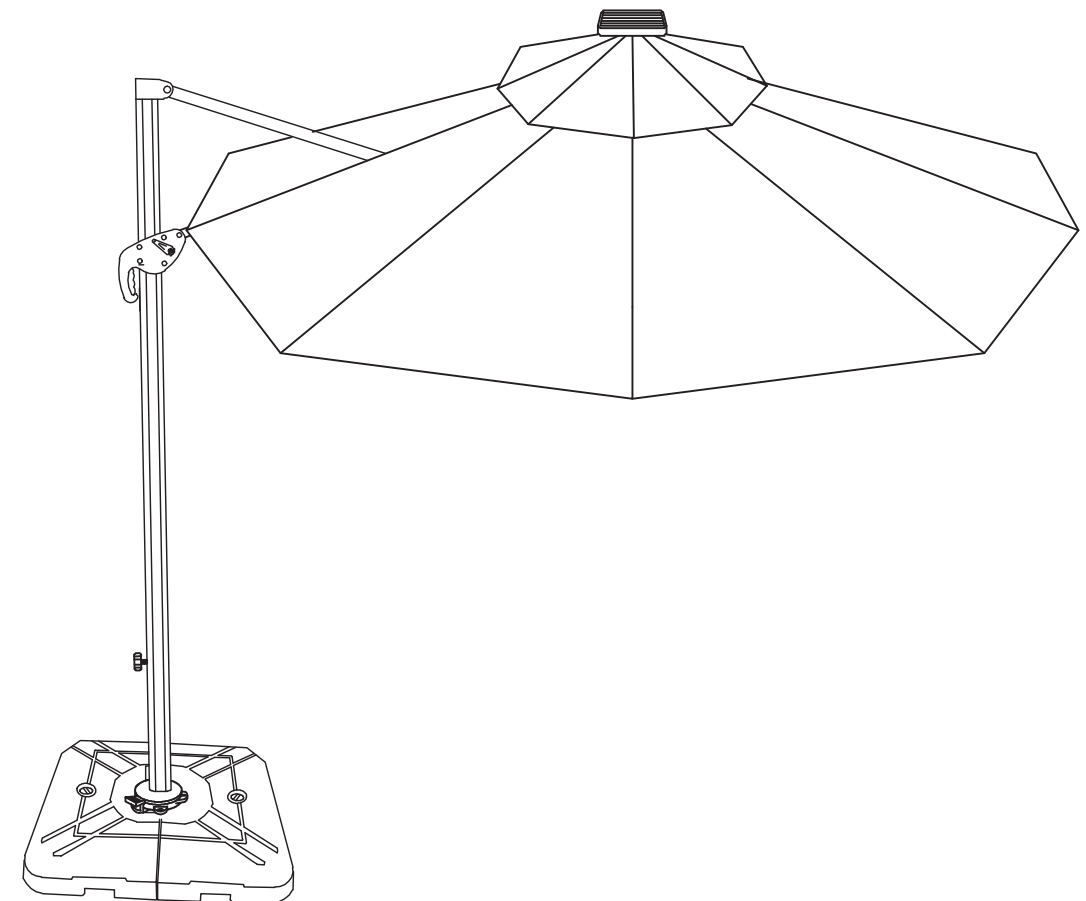

ASSEMBLY INSTRUCTION

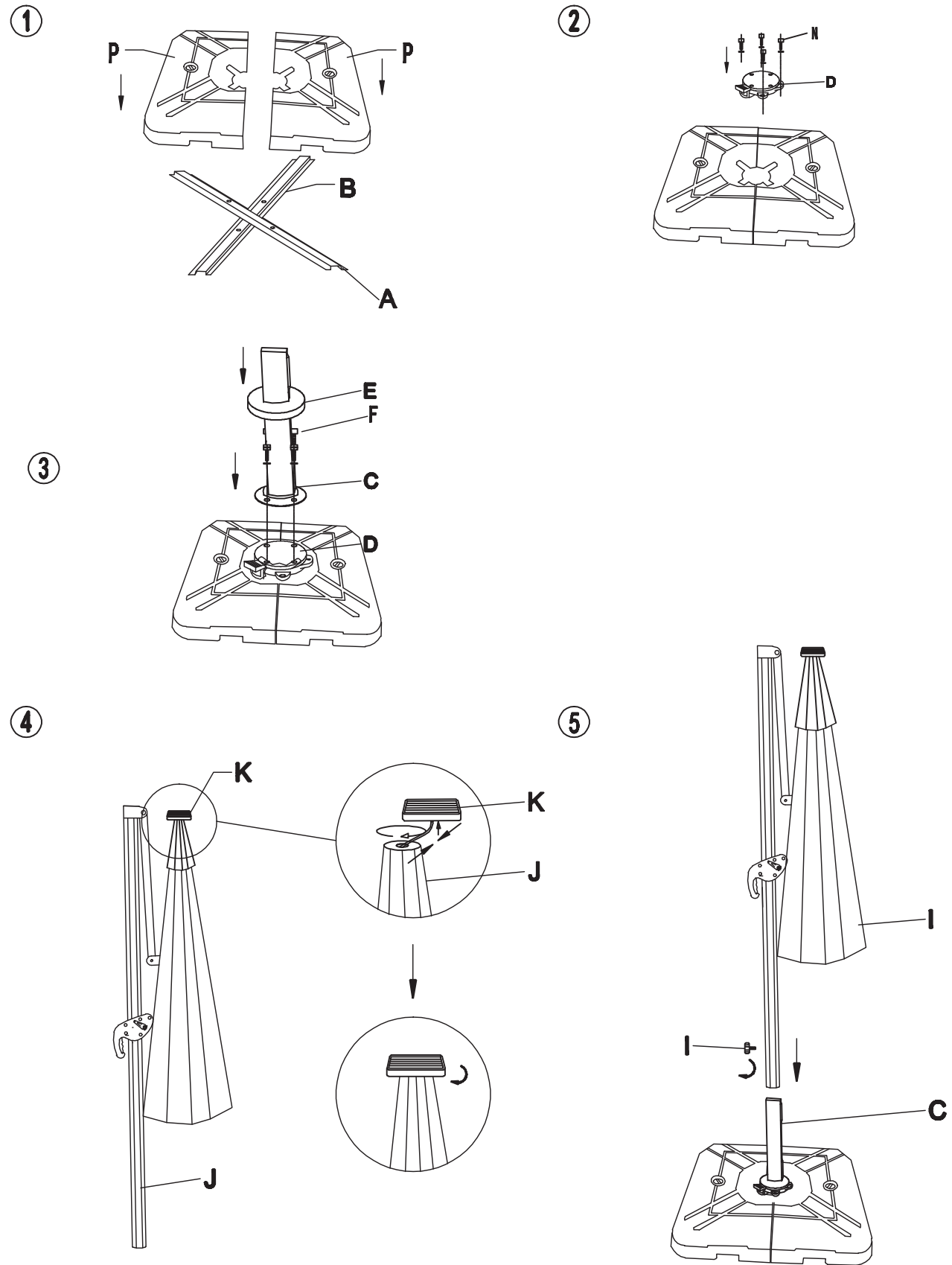

ASSEMBLY INSTRUCTION

