

Assembly Instruction



ASSEMBLY TIME PER UNIT:



20MINUTES

PARTS IDENTIFICATION

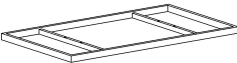





B1:TOP MARBLE AND FRAME

- 1 TOP MARBLE  1pc
- 2 FRAME  1PC

B2:BOTTOM

- 3 LEG  1PC
- 4 BOTTOM  1PC

HARDWARE LIST

NO.	SIZE	DIAGRAM	QTY
A	Ø8X10		4
B	Ø10		8
C	M8X25		4
D	M8X40		4
E	8MM		1
F			6

Hardware pack is located in B2

ASSEMBLY INSTRUCTION

STEP : 1

Assemble step1 already

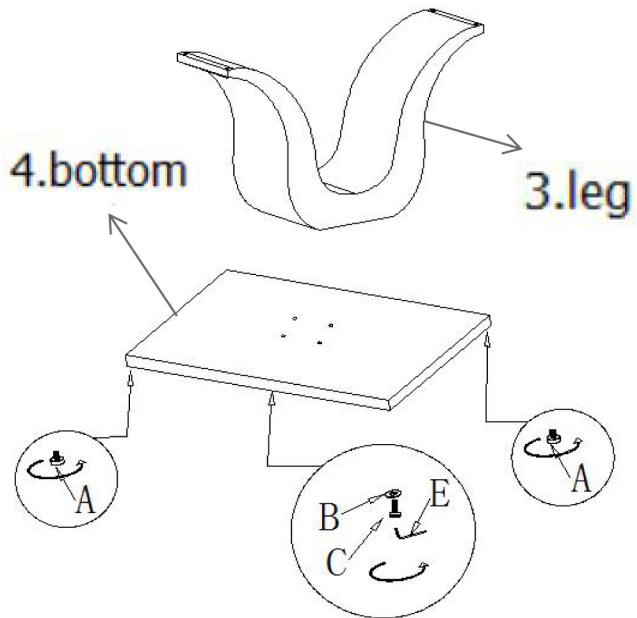

STEP : 2

Low cross rail
on the upside
(Lower four side frame)

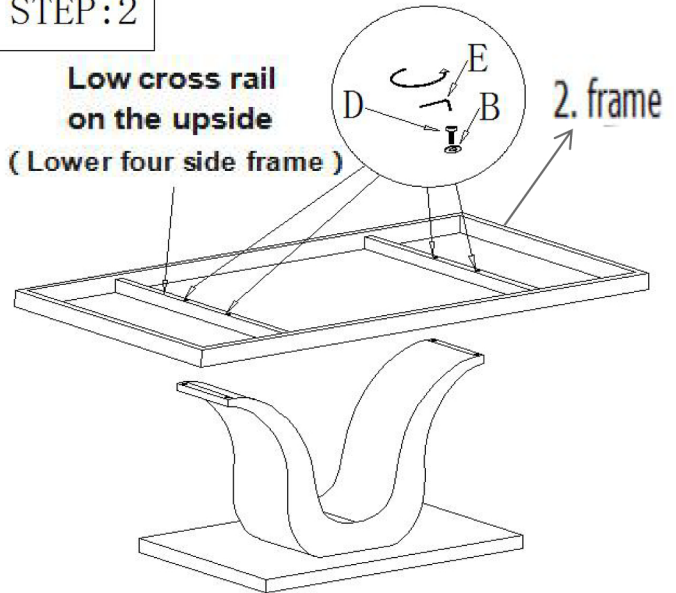

STEP : 3

1.top marble

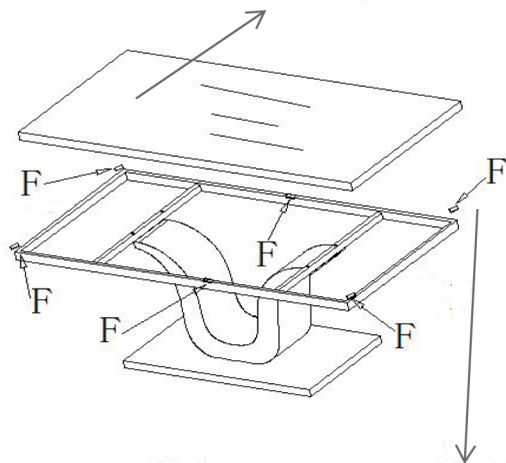

take off the protection for "F"
then stick to frame

STEP : 4

