

PARTY TENT

4X6 M
13X20 FT

SKU:E-YHPT2346-G017-1
E-YHPT2346-G017-2

ASSEMBLY INSTRUCTIONS

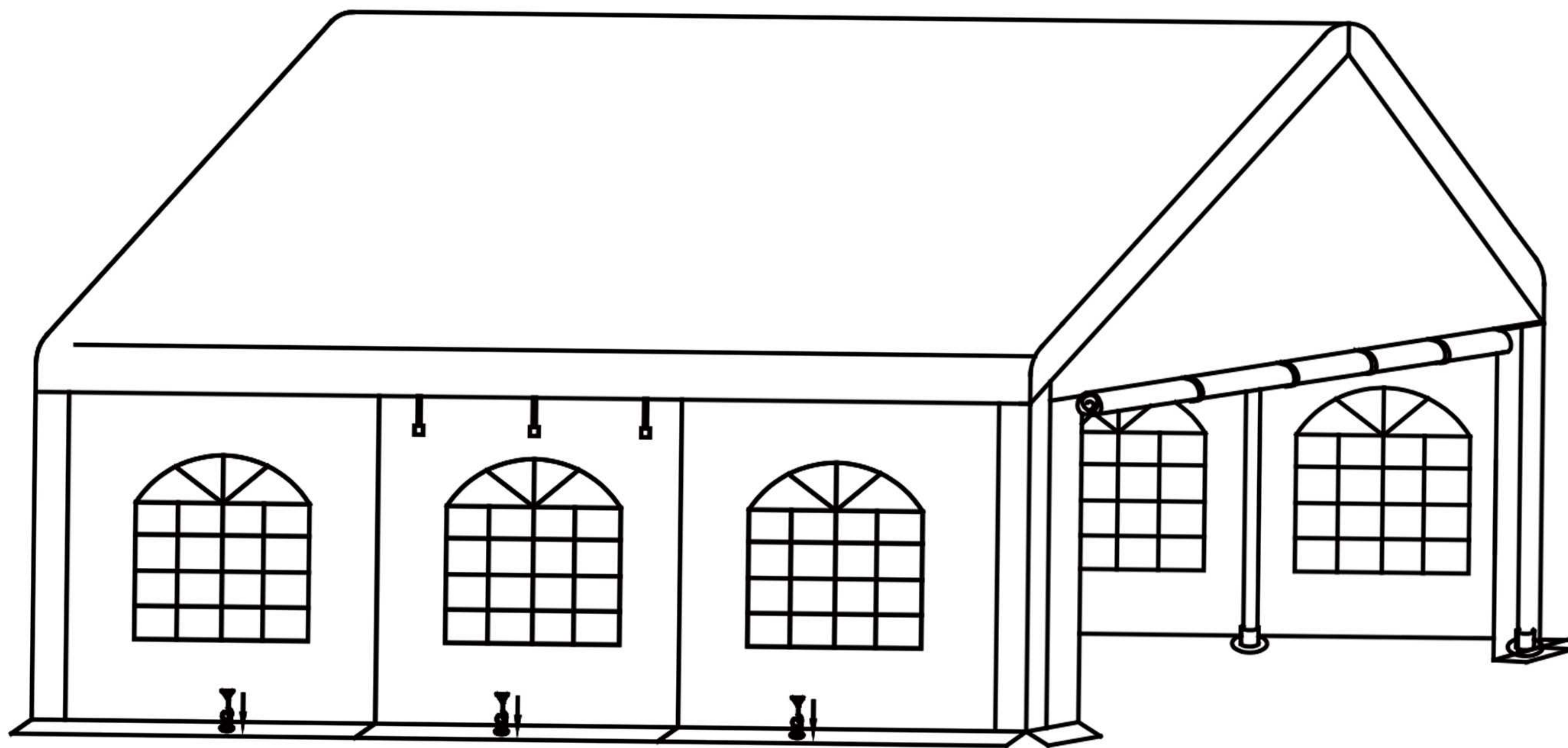

Please check the number of parts in the following accessory catalogue when unpacking. We have sent you more small parts for spare. If there is any missing or any questions about the installation. Please feel free to contact us. We will reply within 24 hours.



E-mail: cs.helper01@gmail.com

TOOLS RECOMMENDED

*NOTE: The recommended tools are not included in boxes and need to be prepared by yourself.



DRILL



RUBBER Mallet



STEPLADDER
(6.5Ft Or More)



SAFETY HAT



GLOVES



SAFETY GOGGLES



ATTENTIONS

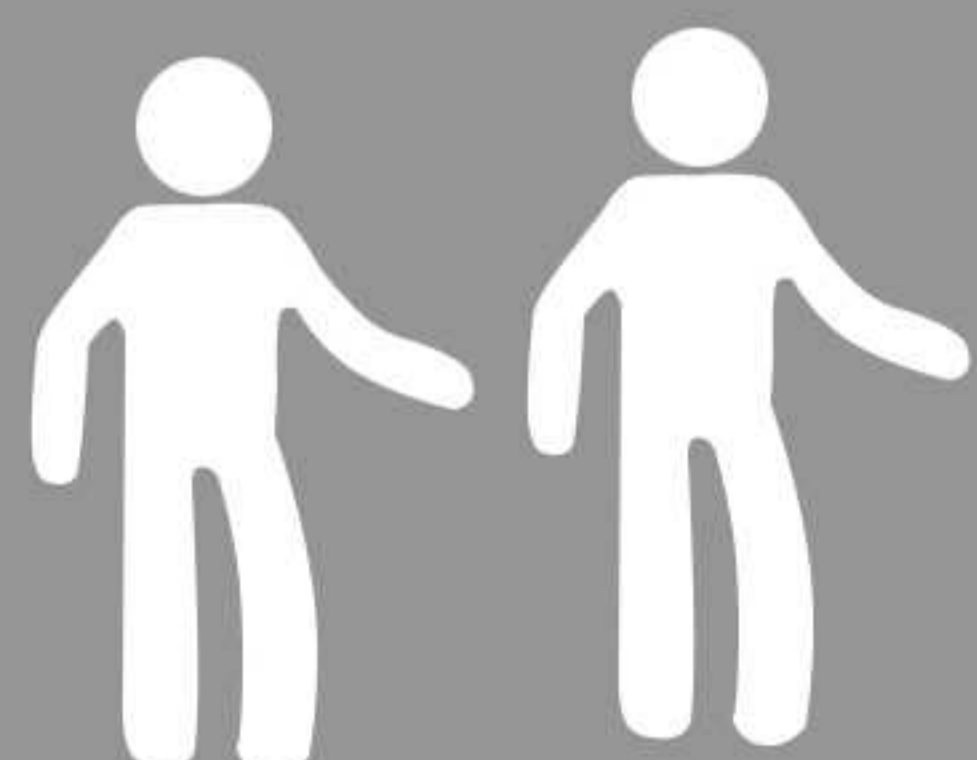

Two or more people are required for assembly



To better align the screws for practical situations, do not fully tighten screws initially



Please reinforced the Gazebo and do not use in heavy winds or inclement weather



Make sure all screws are tightened before use and check all screws, buckles and straps every 90 days



Since it is easy to lose many small accessories during the installation, please collect all the the screw accessories before the assembly is completed





Please clear the snow off the roof in time for the heavy snowfall and do not use it

ACCESSORY CATALOGUE

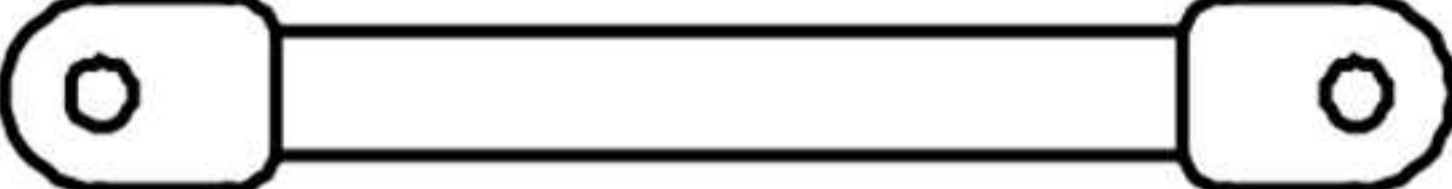

BOX 1

SKU:E-YHPT2346-G017-1



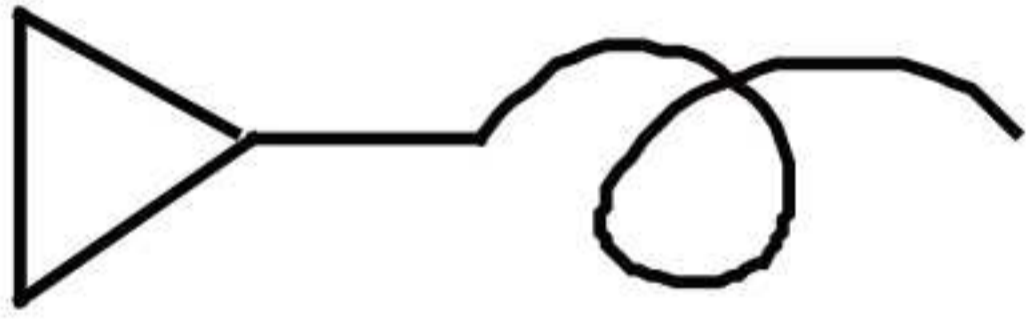

Item no.	Reference Image	Qty.	Item no.	Reference Image	Qty.
1		8	3		8
2		9	6		4

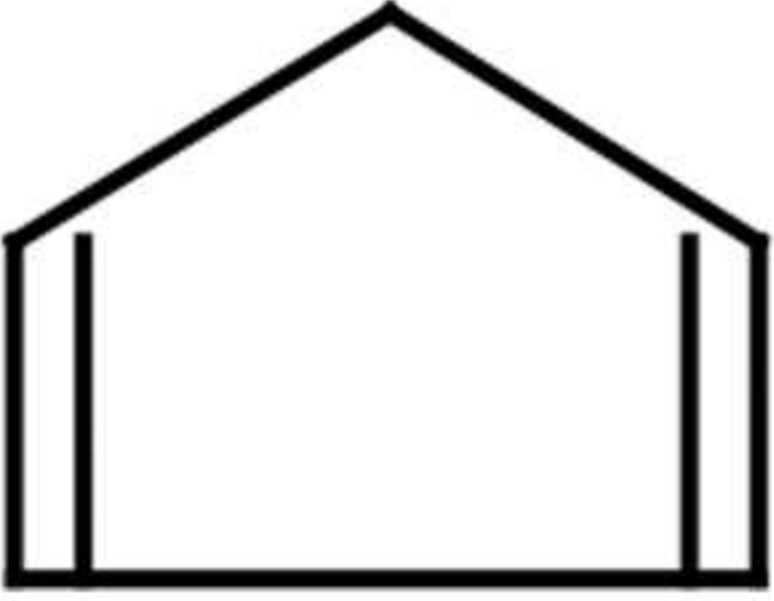
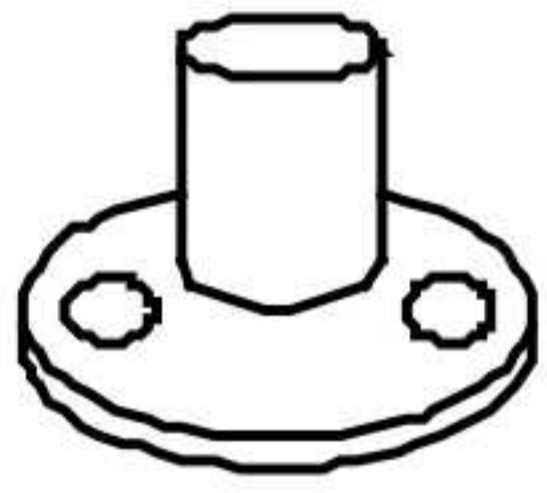
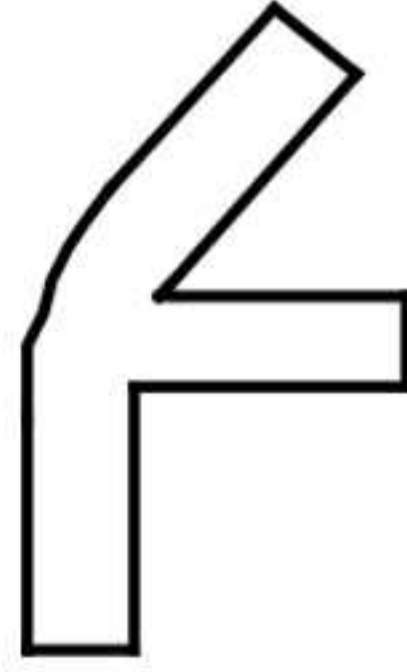
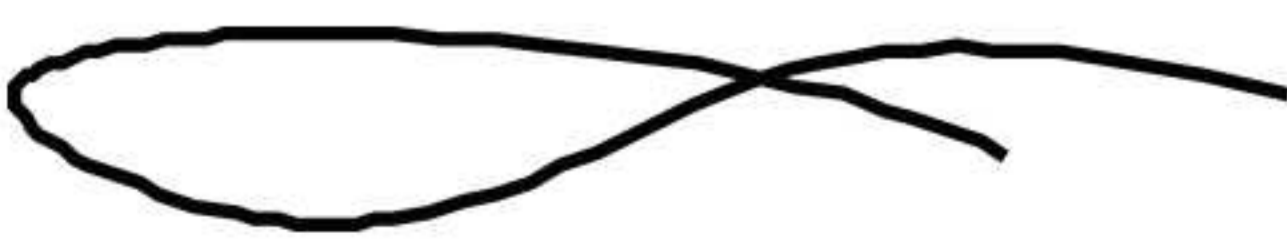
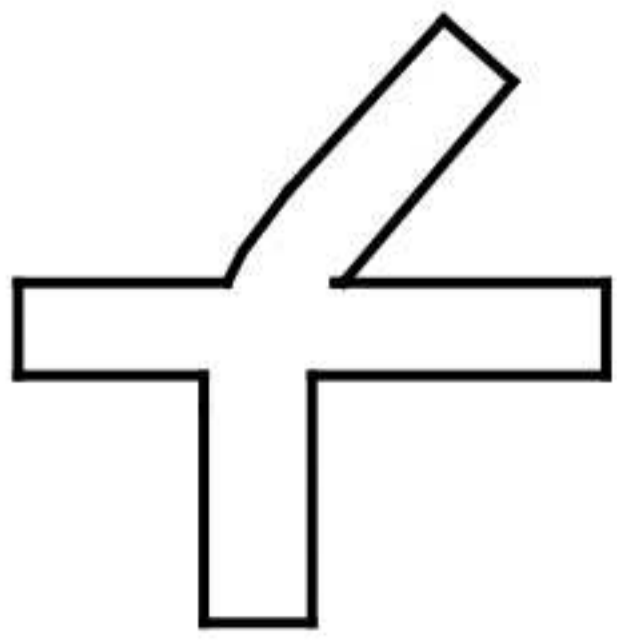
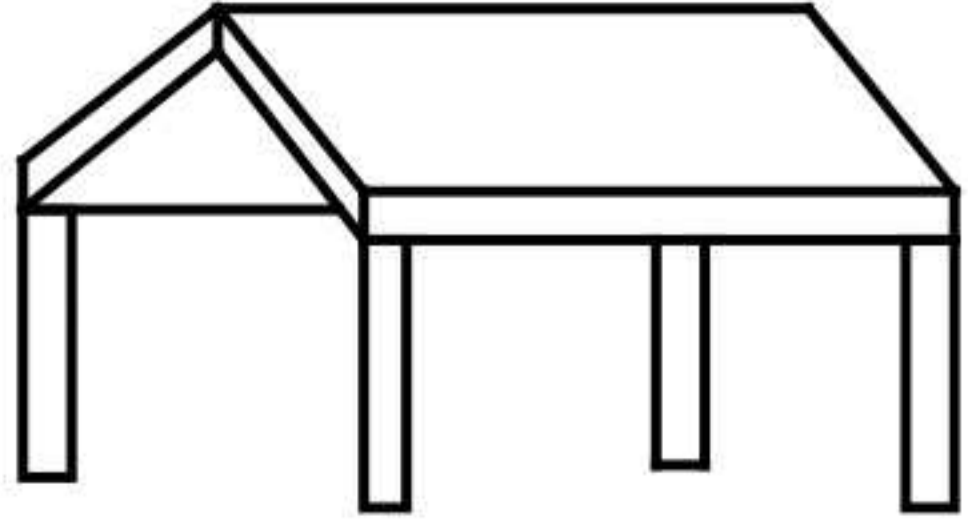
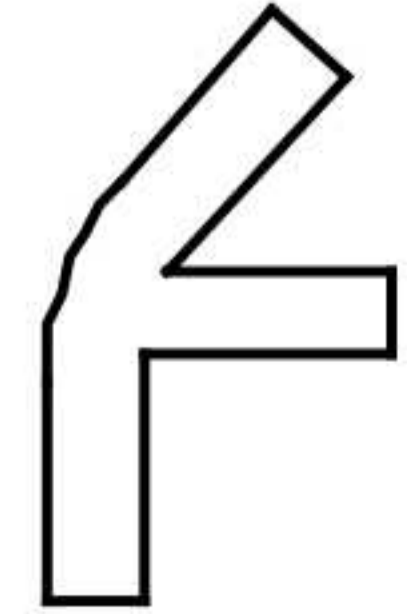
BOX 2

SKU:E-YHPT2346-G017-2

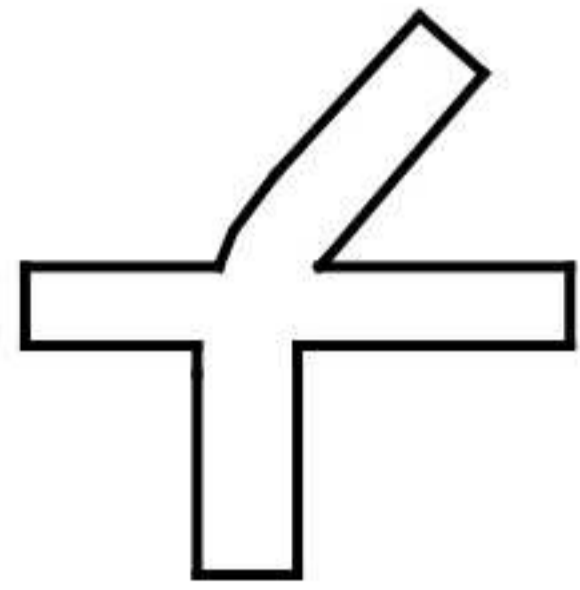
Item no.	Reference Image	Qty.	Item no.	Reference Image	Qty.
4	 ø4*150mm	14	10		2
5		4	11		2
7		8	A		2
8		4	B		2
9		1	A1		4

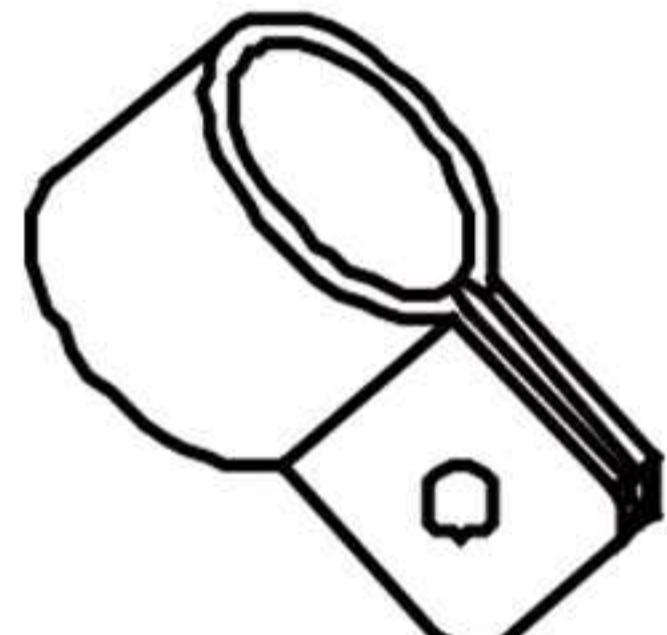
ACCESSORY CATALOGUE

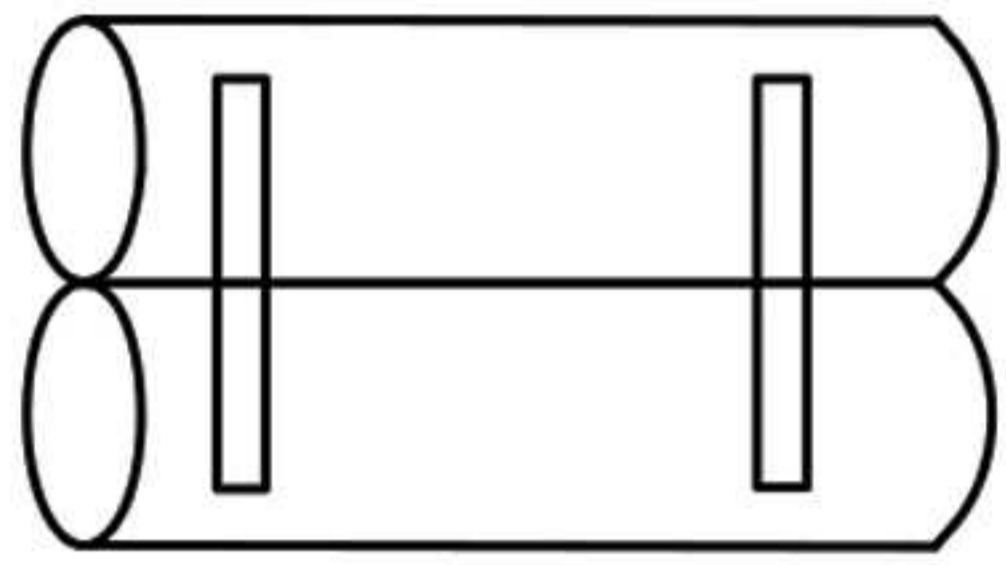
Item no.	Reference Image	Qty.	Item no.	Reference Image	Qty.
B1		4	E	 M6x25	8
C		8	F	 M8x50	8
D		64	SANDBAG		4

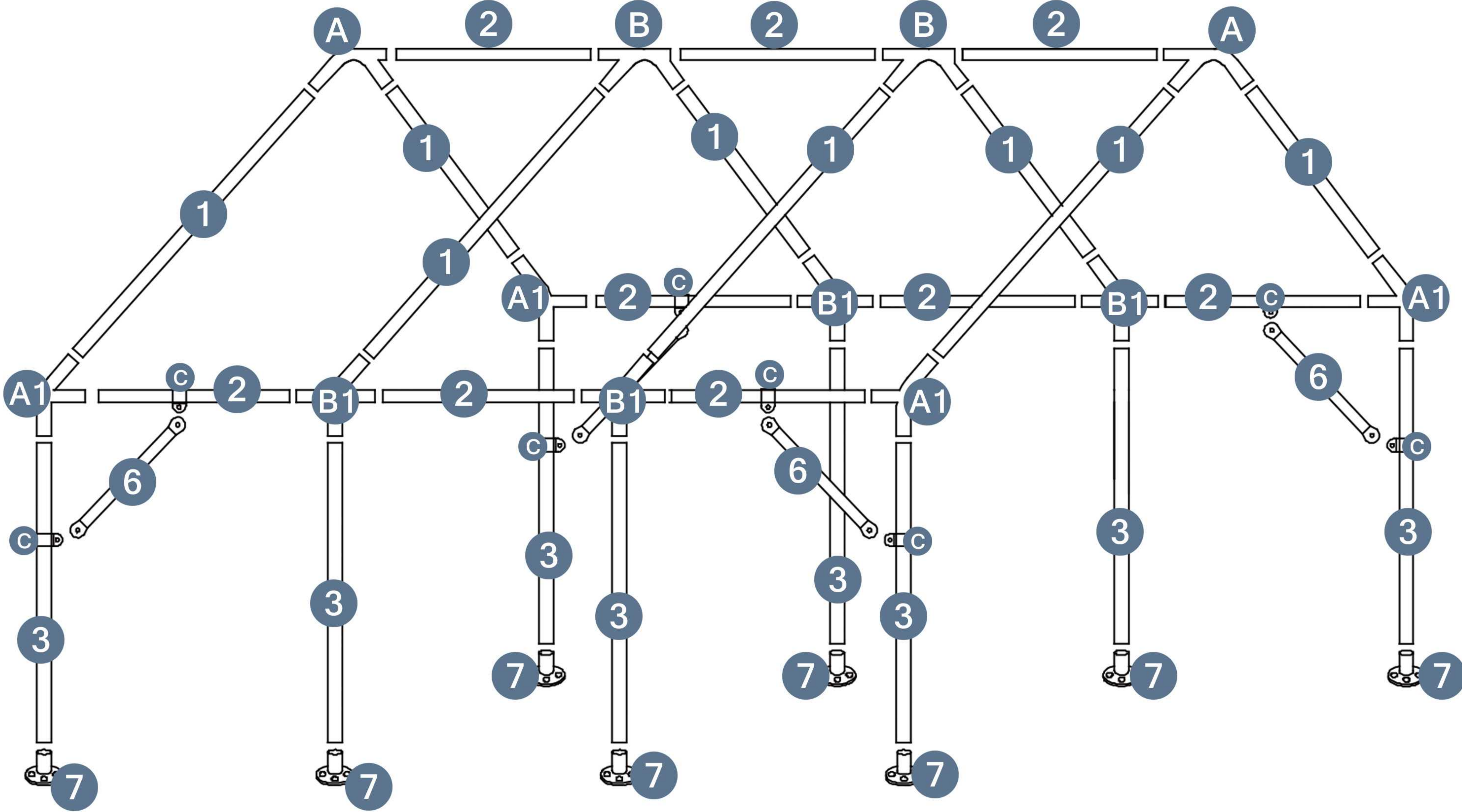

P1-1

STEP 1

Parts required

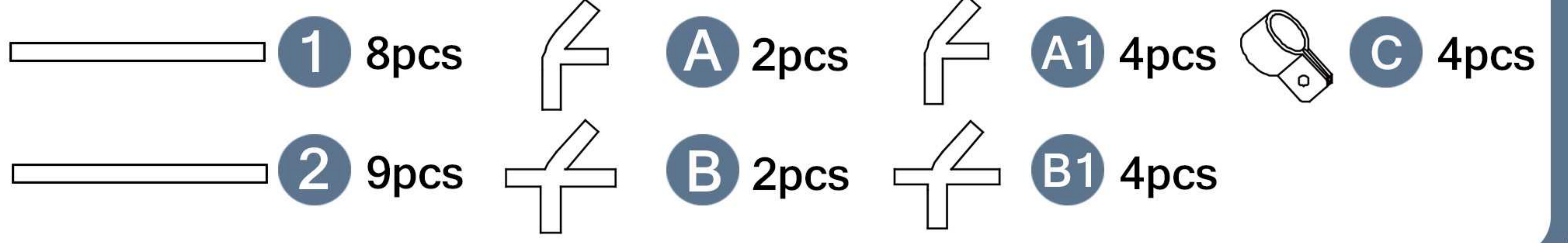

For convenience, please place each accessory according to the position shown in the figure, and then start to build.

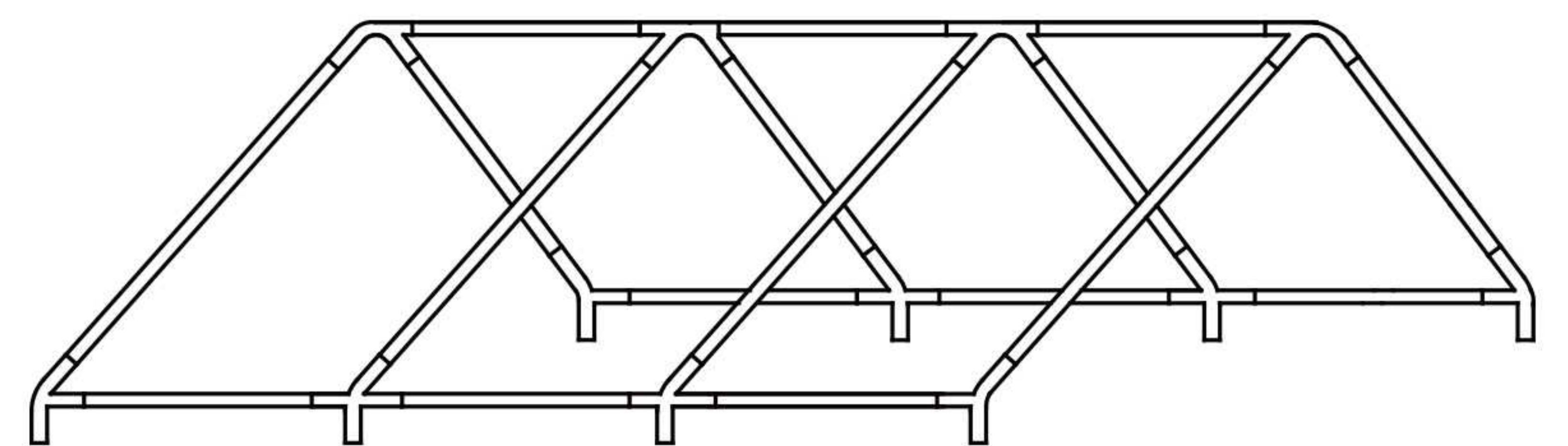
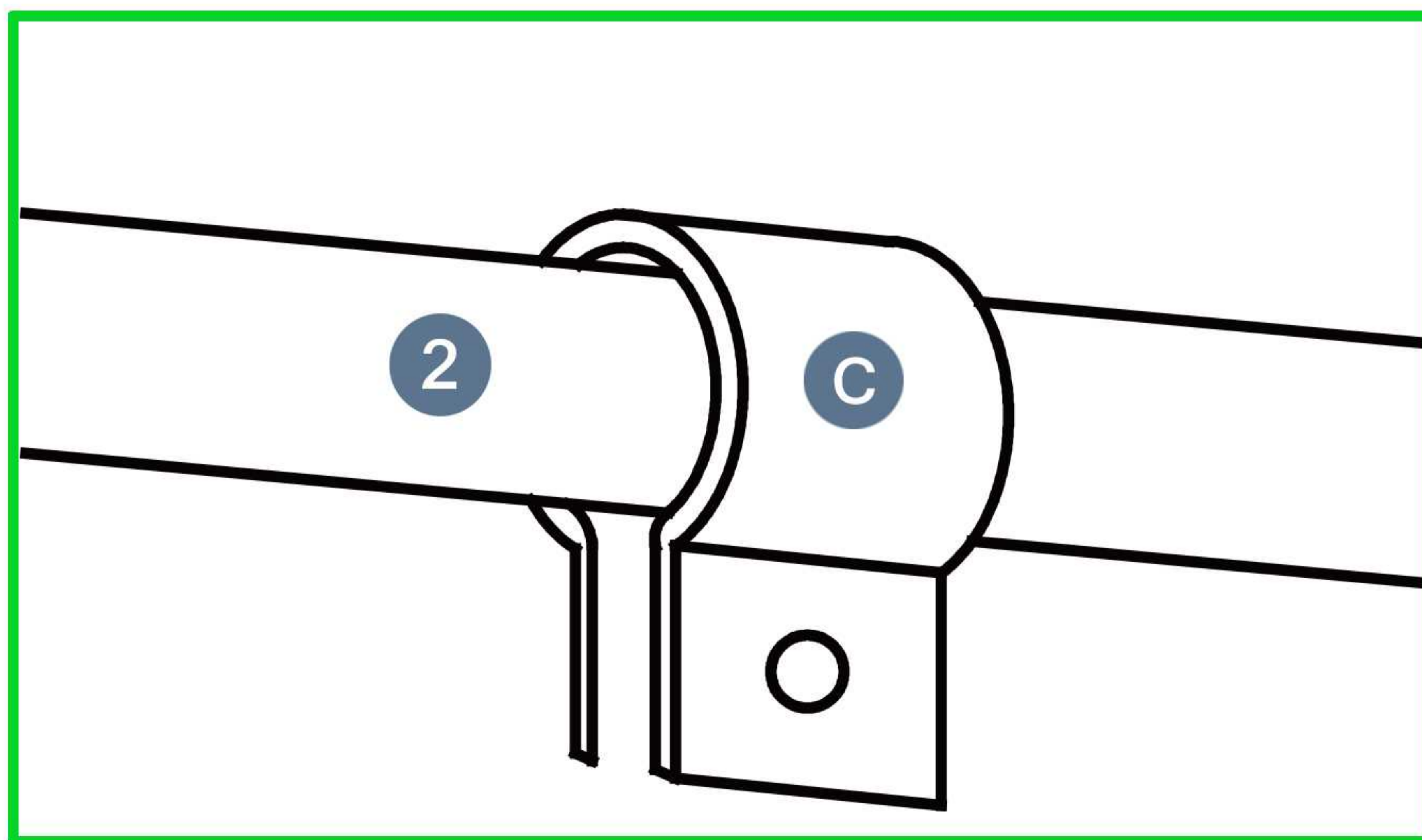
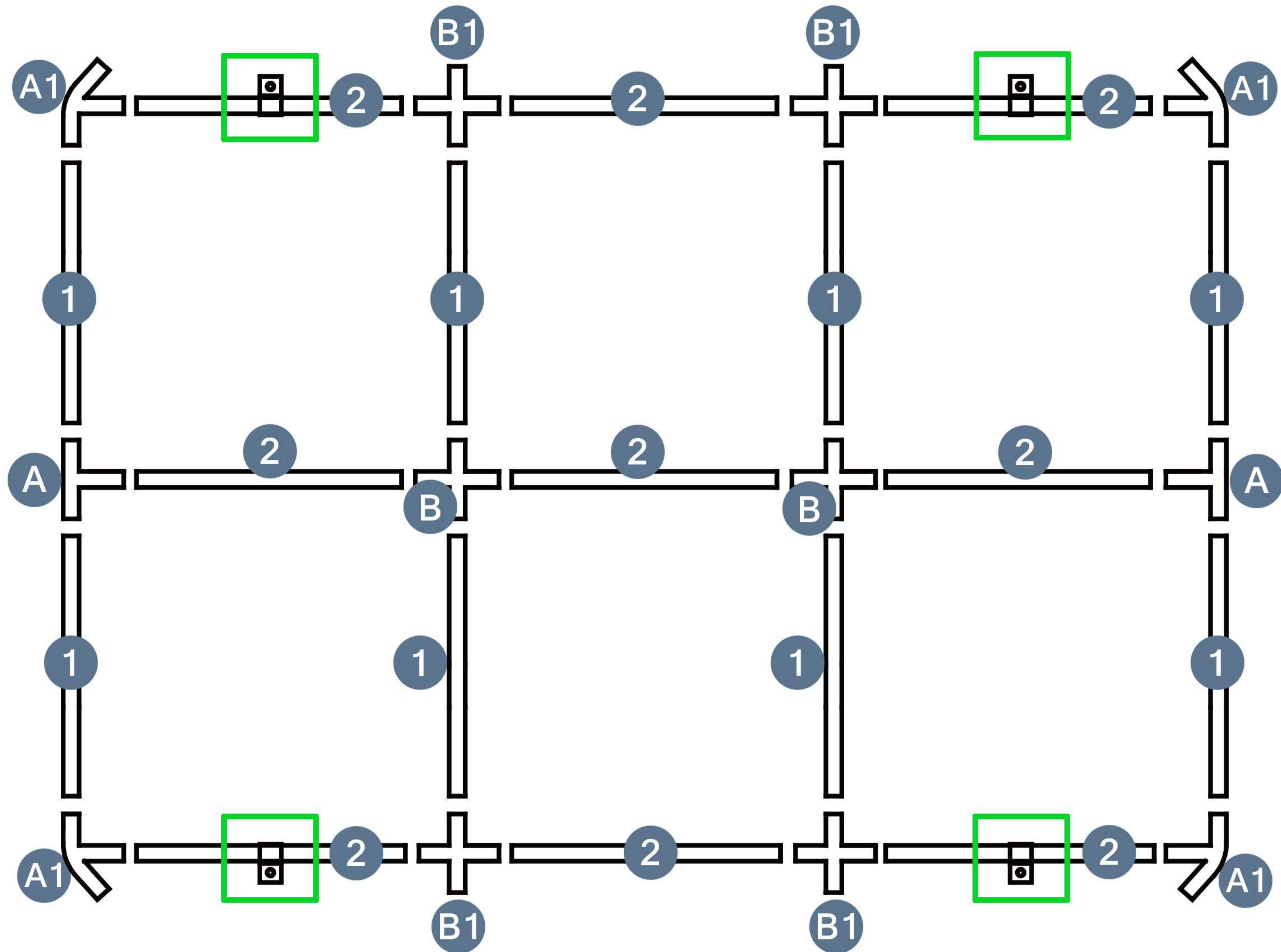

What it looks like after it is set up

STEP 2

Parts required

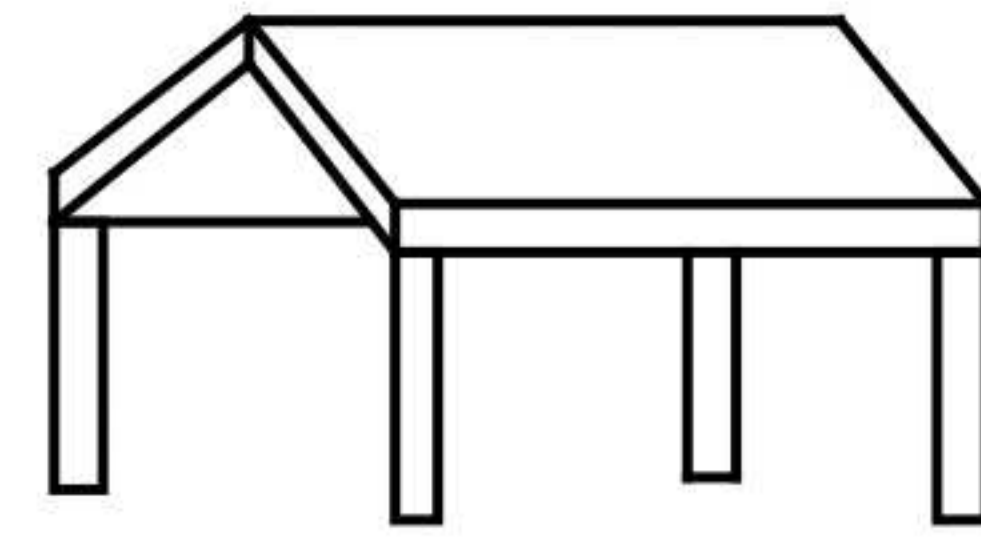

9 1pcs

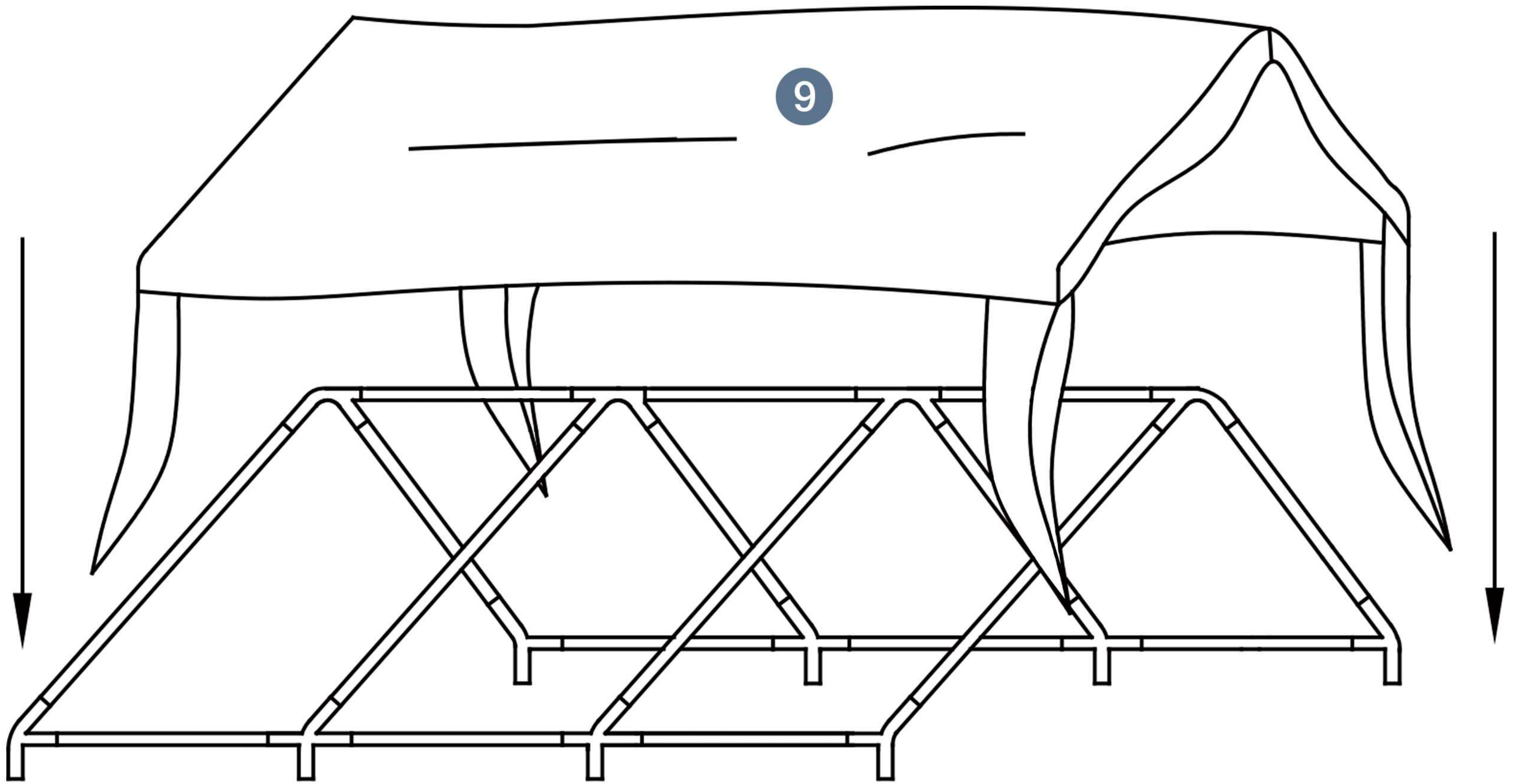

STEP 3

Parts required

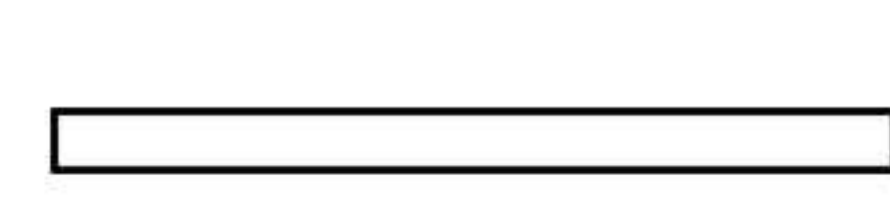

3 8pcs

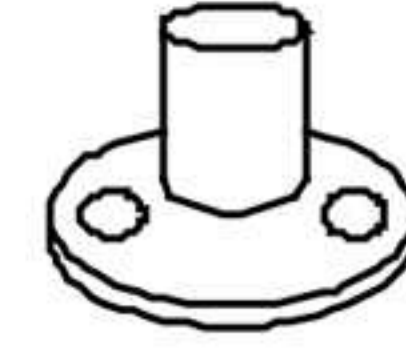

7 8pcs

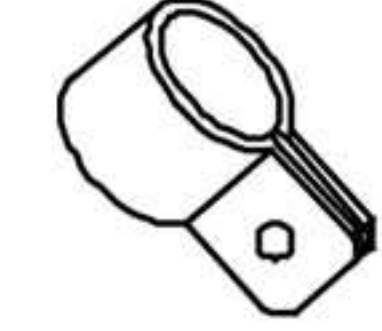

C 4pcs

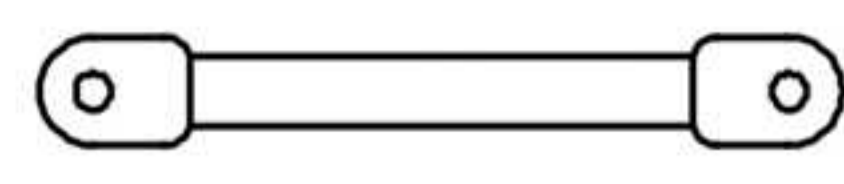

6 4pcs



E 8pcs



F 8pcs





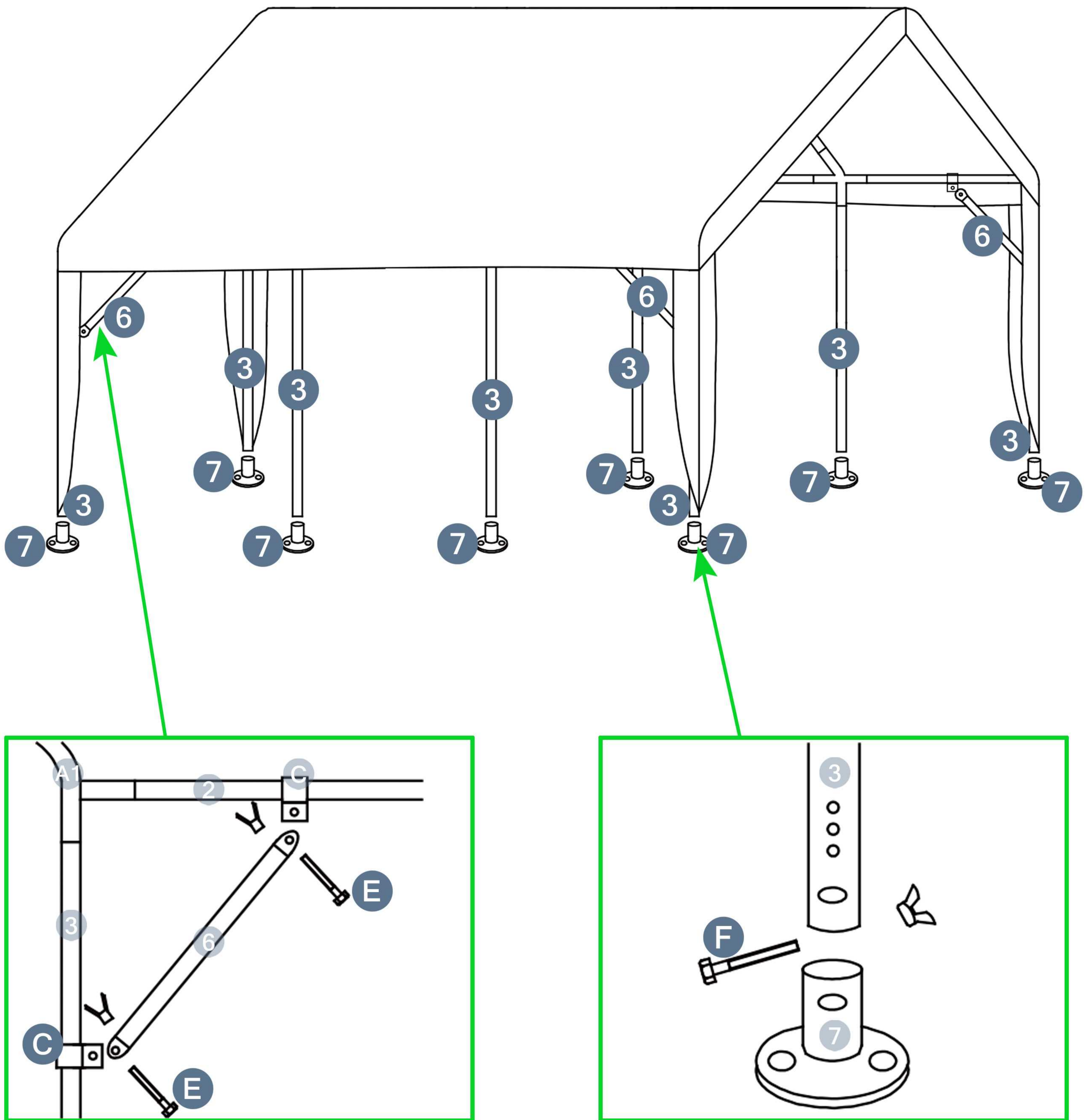

In order to ensure that the installation is correct, please refer to the p1-1 figure at the bottom of page 4.

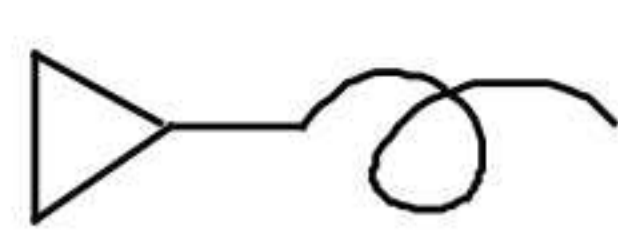
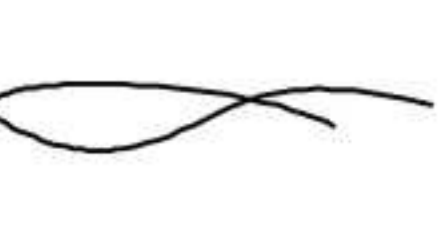

STEP 4

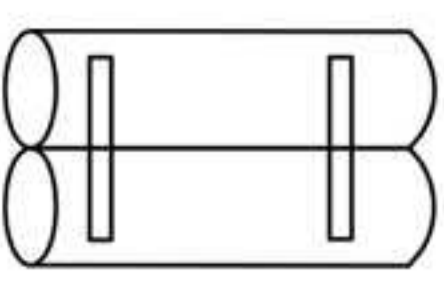
Parts required

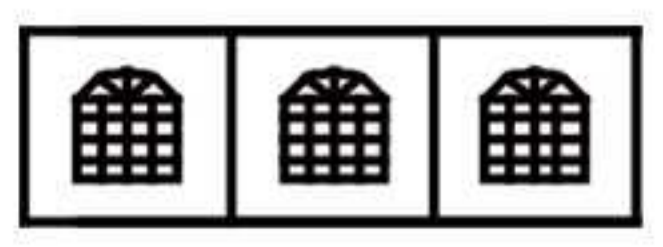
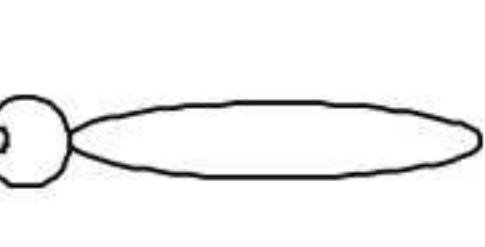
-  4 14pcs
-  8 4pcs
-  11 2pcs
-  SANDBAG 4pcs
-  5 4pcs
-  10 2pcs
-  D 64pcs

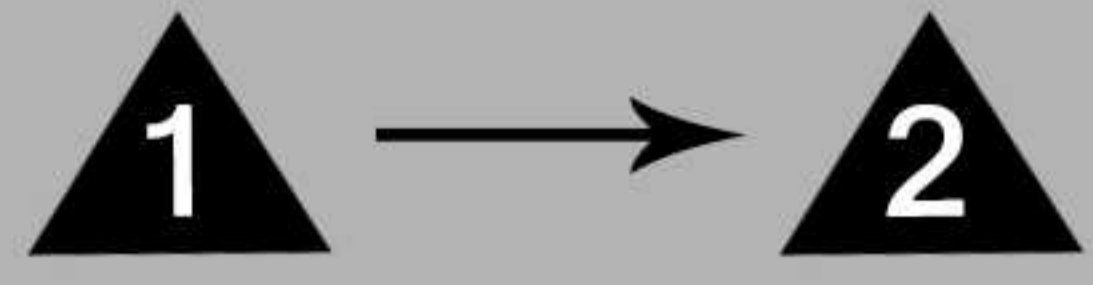

Please install all the D first, and then install the remaining steps.

