



# Office Chair

User Manual



## Product specification

Product Name: Massage Office Chair  
Size: 74\*53\*33.5 cm / 29.1\*20.9\*13.2 inches

Net Weight: 18 kg/ 39.7 lbs  
Gross Weight: 19.6 kg/ 43.2 lbs

## ATTENTION







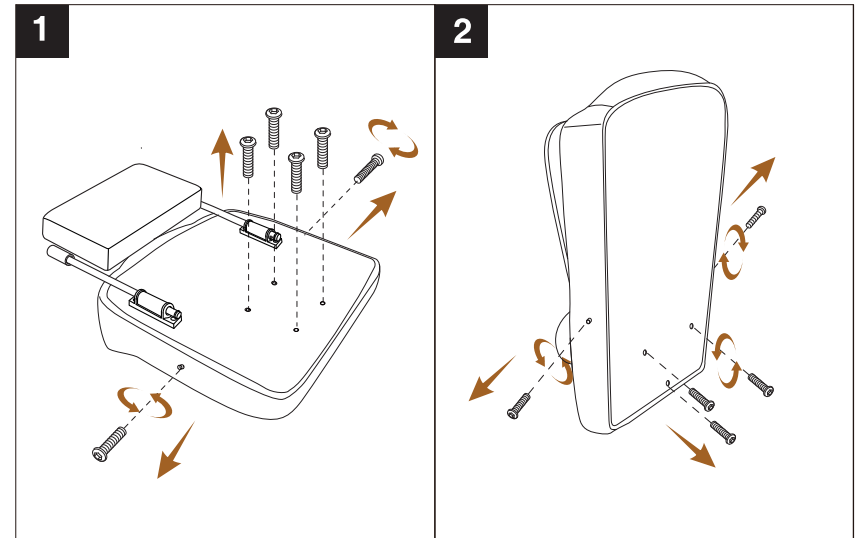



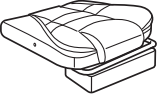

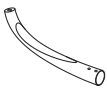

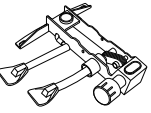

Some screws are pre-installed on the chair and are NOT included in the hardware pack.

Please check the screw number according to the instruction manual and look for it on the chair!

**Please remove  
the pre-installed  
screws before  
installation**

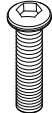
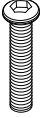

## PACKING LIST

A*1 	B*1 	C*1 	D*5 	N*1 
F*1 	H*5 	P*1 	Q*1 	U*1 
R*1 	G-R*1 	G-L*1 	J*4  8*40mm	K*3  6*40mm
M*4 	Z*4  6*20mm	L*10  6x14mm		

## INSTALLATION

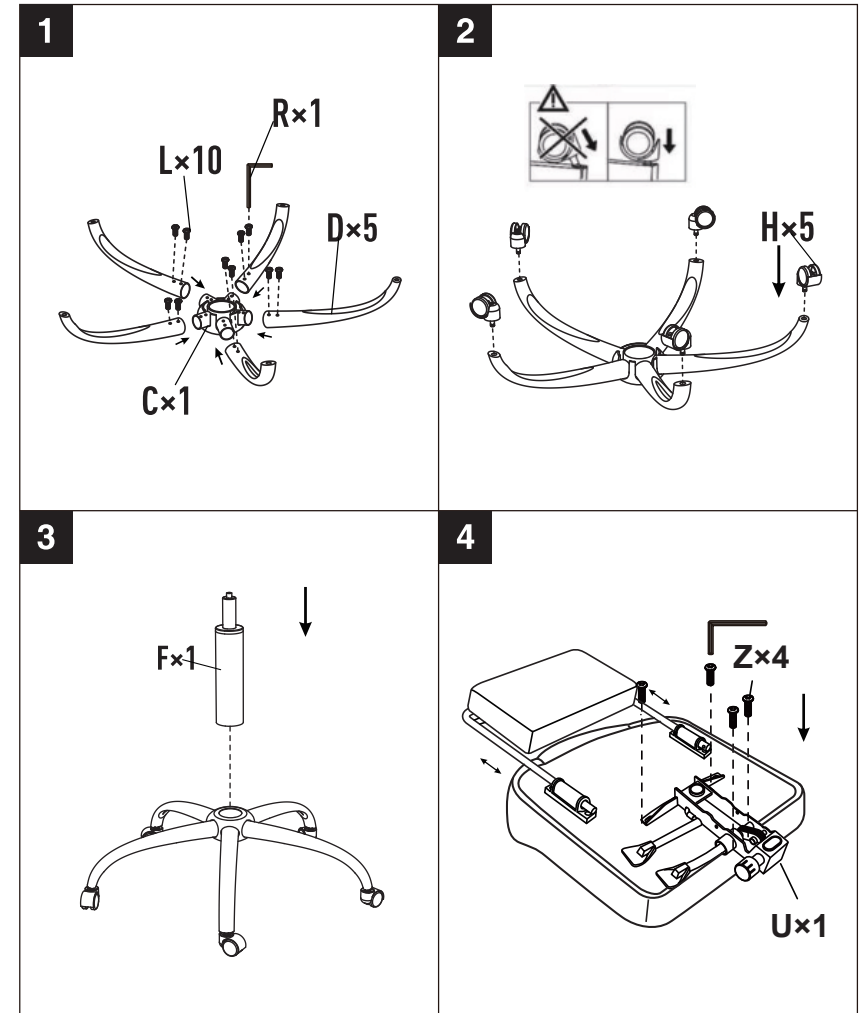

**Note:** All screws have been preassembled to the accessories. Please remove them from the accessories before assembling.

## INSTALLATION

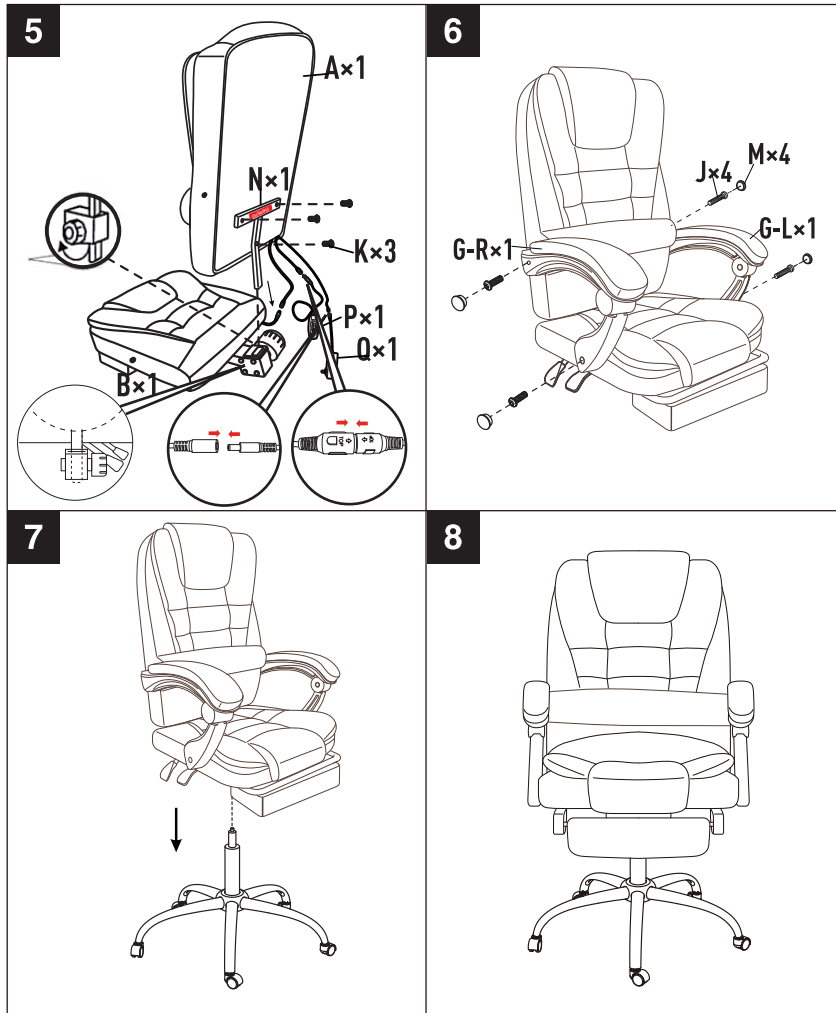

**Note:** All screws have been preassembled to the accessories. Please remove them from the accessories before assembling.

## TROUBLESHOOTING

Fault conditions	Possible causes	Exclusion method
The product is shaking and unstable	<ol style="list-style-type: none"> <li>1. Wrong screw installation</li> <li>2. The screw is broken</li> <li>3. Check that the screws are not tightened in place</li> </ol>	<ol style="list-style-type: none"> <li>1. According to the instruction manual, install the correct screw in the correct position</li> <li>2. To replace, use the included spare screws</li> <li>3. Tighten the loose screws</li> </ol>
The light strip is off	<ol style="list-style-type: none"> <li>1. Not plugged in</li> <li>2. The lighting pattern is not saved correctly</li> </ol>	<ol style="list-style-type: none"> <li>1. Confirm that the product is powered on normally</li> <li>2. Please read the instructions of the remote control carefully (page 6), and follow the operation</li> </ol>
Audio doesn't work	<ol style="list-style-type: none"> <li>1. Bluetooth connection failed</li> <li>2. Bluetooth connection error</li> </ol>	<ol style="list-style-type: none"> <li>1. Turn on your phone's bluetooth to connect</li> <li>2. Turn off the phone's Bluetooth and reconnect (Bluetooth name: HuaBox)</li> </ol>
Remote control not working	<ol style="list-style-type: none"> <li>1. The remote control gasket is not pulled out and cannot work</li> <li>2. The battery is in poor contact or the battery is installed backwards</li> <li>3. The battery is dead</li> </ol>	<ol style="list-style-type: none"> <li>1. Check whether the remote control gasket is pulled out</li> <li>2. Check whether the battery is installed incorrectly and adjust</li> <li>3. Replace the new battery to make the remote control work normally</li> </ol>

## WARRANTY & SUPPORT

Thanks for purchasing our product. For any advice about the product or wanna know other products.

Please visit official website Amazon.

Your purchase and support will be our driving force!