

Item No.	Cat Litter Box Enclosure	Height	
		500 × 965 × 460 mm	

No.	Description	Measurement in mm	Quantity
No. 1	Door Plate	762 × 476 × 18	1
No. 2	Drawer Front Panel	124 × 476 × 18	1
No. 3	Front Panel	55 × 480 × 18	1
No. 4	Right Side Panel	949 × 434 × 16	1
No. 5	Left Side Panel	949 × 434 × 16	1
No. 6	Top Panel	500 × 460 × 16	1
No. 7	Bottom Plate	448 × 434 × 16	1
No. 8	Top Shelf Panel	448 × 418 × 16	1
No. 9	Bottom Shelf Panel	448 × 400 × 16	1
No. 10	Back Drawer Panel	448 × 55 × 16	1
No. 11	Drawer Back Panel	389 × 85 × 16	1
No. 12	Drawer Right Side Panel	350 × 85 × 16	1
No. 13	Drawer Left Side Panel	350 × 85 × 16	1
No. 14	Drawer Bottom Panel	401 × 346 × 5	1
No. 15	Back Panel	888 × 458 × 5	1
No. a	Cam Lock	∅ 15 × 12	36
No. b	Bolt for Cam Lock	M8 × 40	36
No. c	Sticker		36
No. d	Dowel 8*40mm	∅ 8 × 40	18
No. e	Countersunk screw 4*14mm	M4 × 14	28
No. f	Hinge		2
No. g	Closing Latch, Magnetic		1
No. h	Screw 4*20mm	M4 × 20	2
No. i	Knob		2
No. j	Drawer slides	D350	1
No. k	Adjustable feet		4

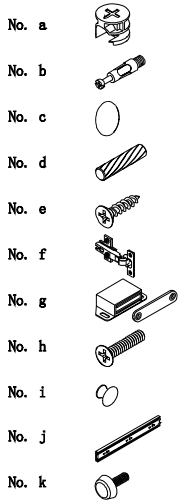

Advice:
Do not sit or stand on this product.
It is intended for pets only.
This product should be assembled by
an adult.

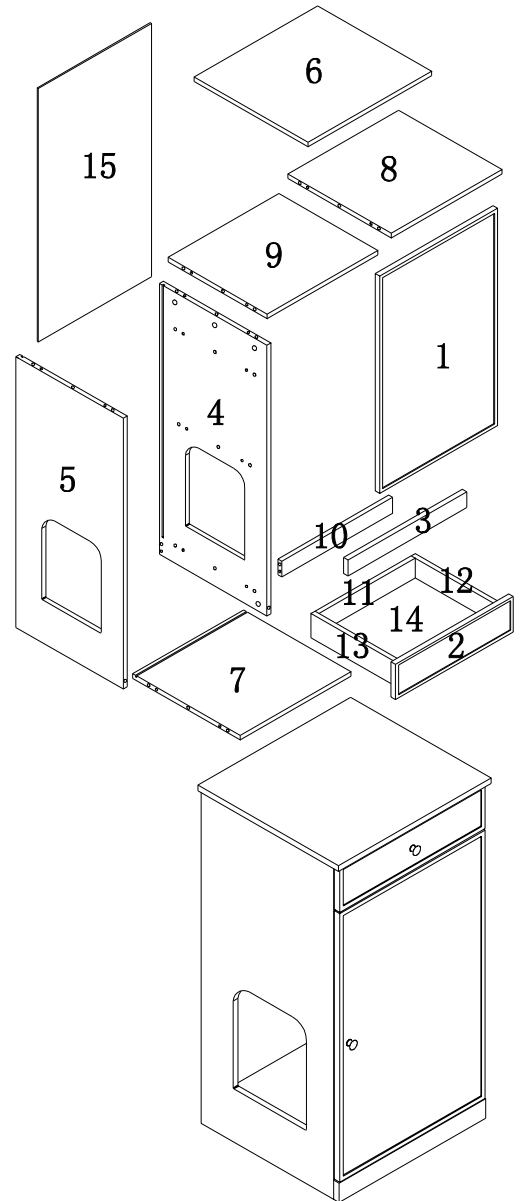
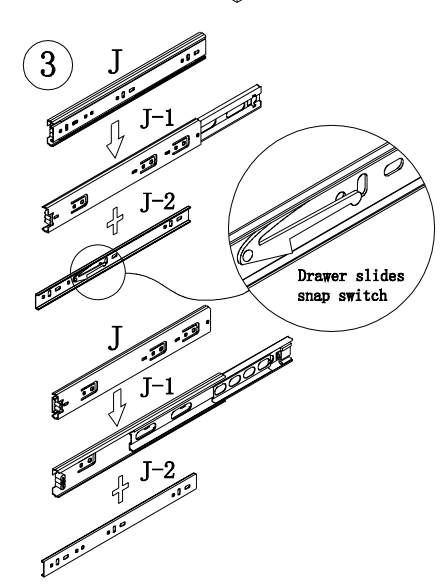
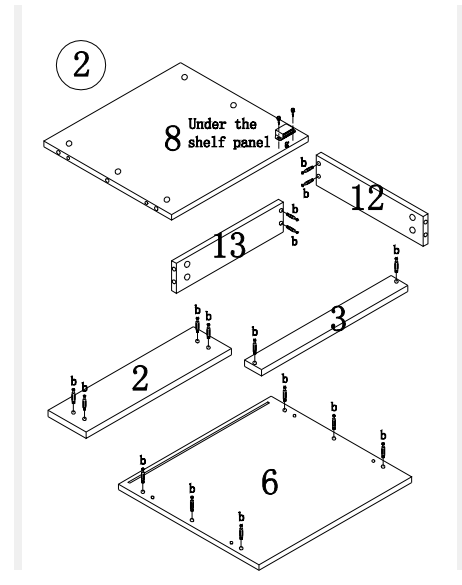
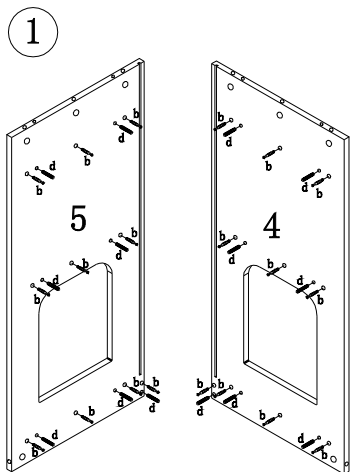

nails are recommended
to be mounted at the
guide hole location

