

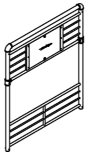

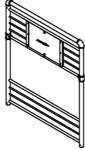

ASSEMBLY INSTRUCTION

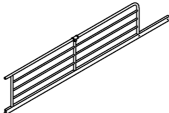

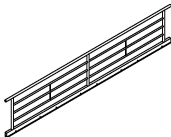

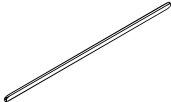
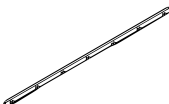
Twin/Twin Bunk Bed

Thank you for purchasing this quality product. Be sure to check all packing materials carefully for small parts which may have come loose inside the carton during shipment. Separate, identify, and count all parts and metal hardware. Compare with parts list to be sure all parts are present. If any part(s) are missing or damaged, please contact your local furniture dealer. For efficient and speedy service, please indicate the model number and code letter of the part(s) needed.

***** Do not fully tighten screws until fully assembled *****

COMPONENT PARTS		
DECERPTION	PART NAME	Q'TY(PCS)
①	Left HB 	1pc
②	Right HB 	1pc
③	Front Guardrail 	1pc
④	Back Guardrail 	1pc
⑤	Side Bed Board 	2pcs
⑥	Middle Bed Board 	2pcs
⑦	Front Bed Board Tube 	1pc
⑧	Back Bed Board Tube 	1pc
⑨	Bed Board Tube 	7pcs

10	Ladder		1pc
----	--------	---	-----

HARDWARE REQUIRED:	
(A) 	Bolt 1/4"x1" - 16pcs
(B) 	Bolt 1/4"x1-3/8" - 4pcs
(C) 	Bolt 1/4"x3" - 3pcs
(D) 	Bolt 1/4"x3" - 12pcs
(E) 	Allen Wrench M4 - 1pc

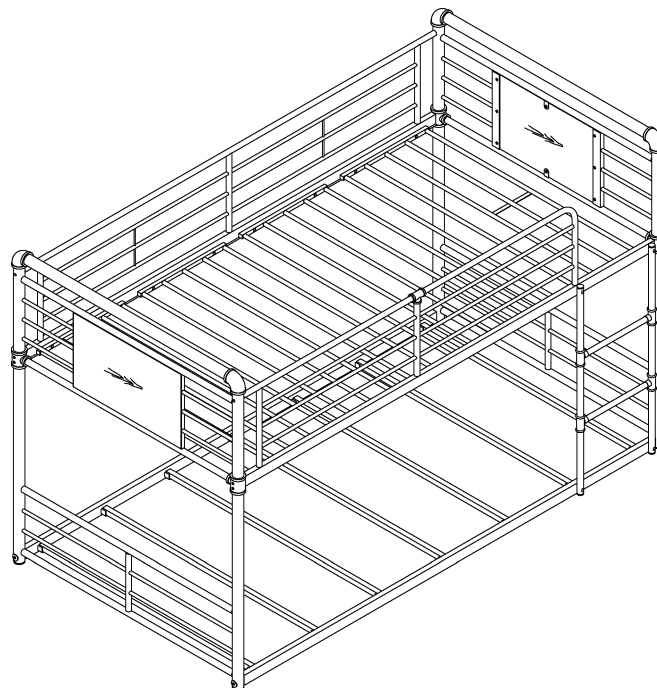

Attention:

***Mattresses not included.

***Some number parts listed on the instruction sheet may not be in parts bag as they may already be assemble.
Carefully check parts and packing materials prior to ordering replacements.

How to Assemble:

STEP 1.

Exploded View

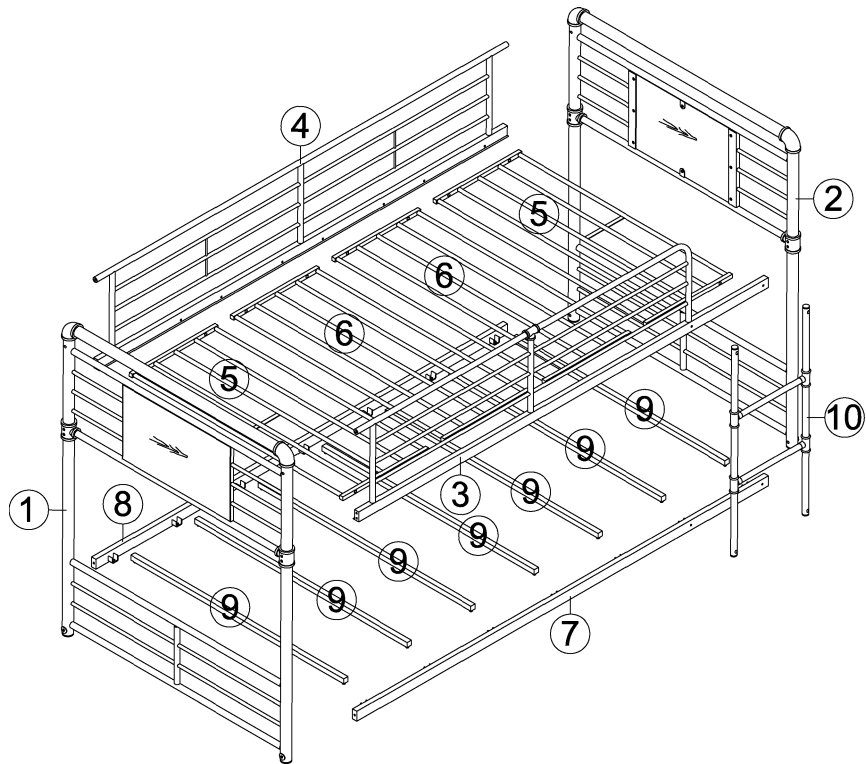

STEP 2.

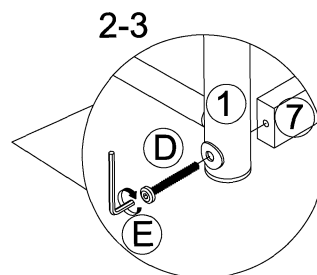
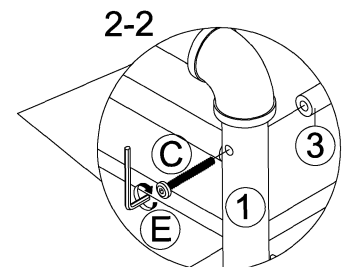
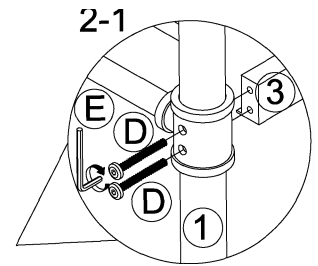
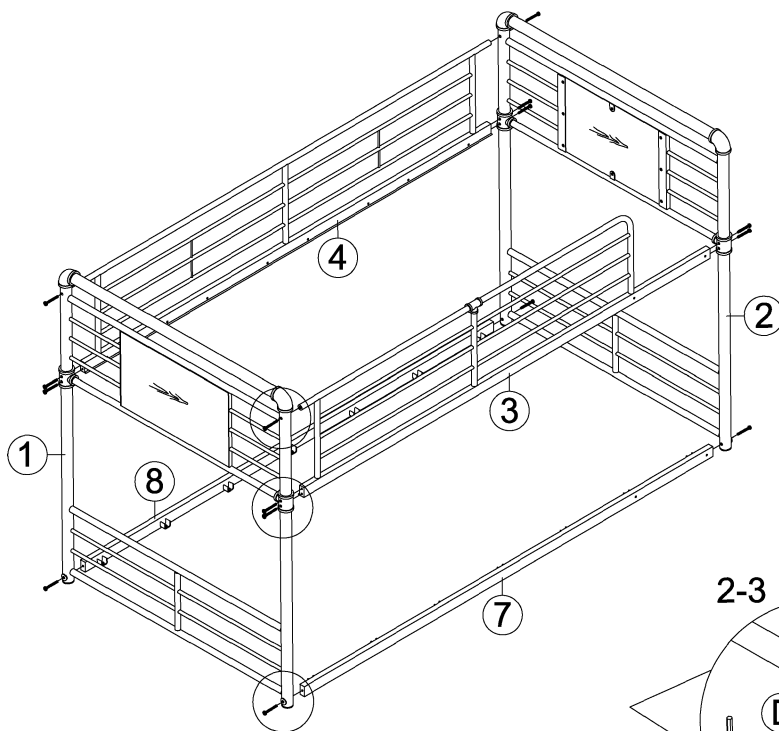

- C 3pcs
- D 12pcs

How to Assemble:

STEP 3.

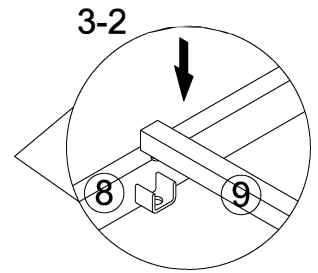
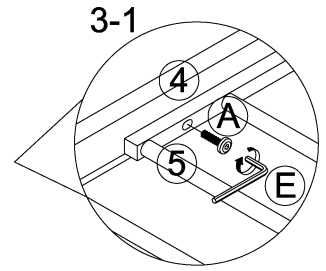
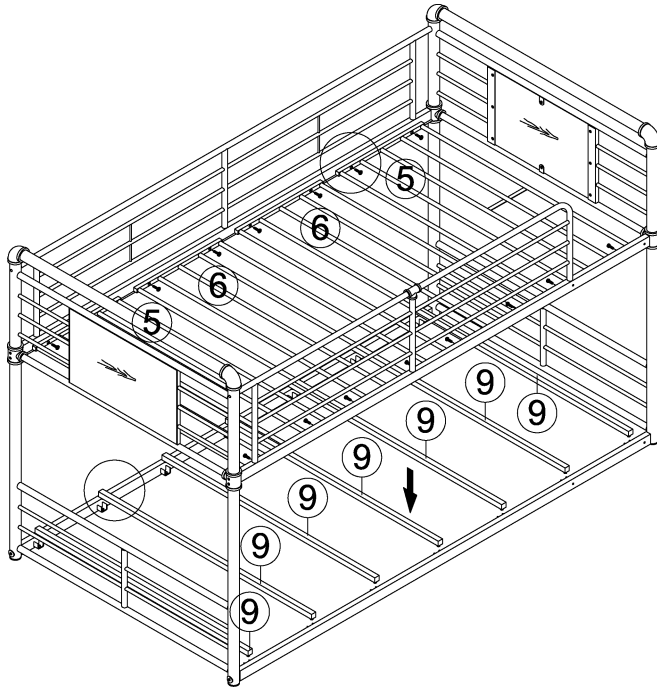

16pcs

STEP 4.

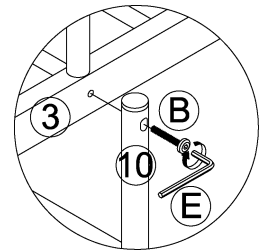
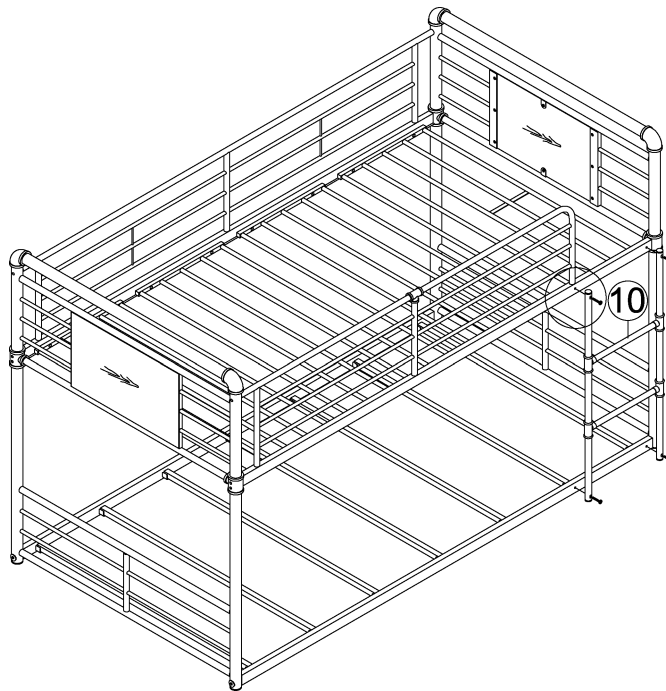

4pcs

Safety Warnings

1. Follow the information on the warnings appearing on the upper bunk end structure and on the carton . Do not remove warning label from bed.
2. Always use the recommended size mattress or/and mattress support to help prevent the likelihood of entrapment or falls.
3. Surface of mattress must be at least 5 in. below the upper edge of guardrails .
4. Do not allow children less than 6 years of age to use the upper bunk.
5. Periodically check and ensure that the guardrail, ladder ,and other components are in their proper position ,free from damage ,and that all connectors are tight .
6. Prohibit horseplay on/or under the bed and prohibit jumping on the bed.
7. Always use the ladder for entering and leaving the upper bunk.
8. Do not use substitute parts ,Contact manufacturer or dealer for replacement parts.
9. Use of a night light may provide added safety precaution for a child using the upper bunk.
10. Always use guardrails on both long sides of the upper bunk.
11. If the bunk bed will be placed next to a wall, the guardrail that runs the full length of the bed should be placed against the wall to prevent entrapment between the bed and the wall.
12. The use of water or sleep flotation mattress is prohibited .
13. Keep these instructions for future reference.
14. Use only mattress which is 74 3/4 "x39" x5" on upper bunk and for bottom bunk required 74 3/4 "x39" x5"mattress.
15. Prohibit more than one person on upper bunk.

STRANGULATION HAZARD:

16. Never attach or hang items to any part of the bunk bed that are not designed for use with the bed for example, but not limited to hooks, belts, and jump ropes.