

1.

Tighten the presser foot

① X5

2.

Place the ⑦ package in the middle of the ② base, align it with the screw holes, and fix it to the ⑥ base with the ② screw.

3.

Align the holes on the edge of the fabric strip of the ⑦ package with the screw holes on the bottom shelf

Align the holes of the fabric strip on the ⑦ and fix the backrest of the ⑧ with the corresponding screws

4.

Align the holes of the fabric strip on the ⑦ and fix the backrest of the ⑨ with the corresponding screws

Align the holes on the edge of the fabric strip of the ⑦ package with the screw holes on the bottom shelf

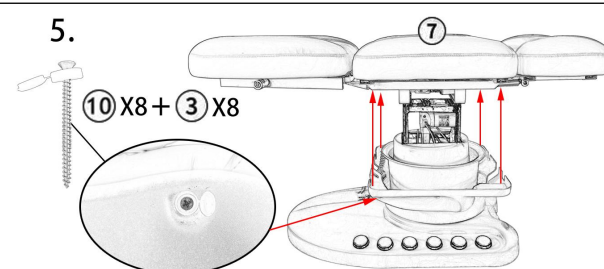
5.  **⑩ X8 + ③ X8**

Fix the bottom shell of the base at the bottom of ⑦

Adjust the bottom shell according to the hole position, and use ⑩ and ③ to fix the bottom shell to the middle package in the reserved position on the bottom shell

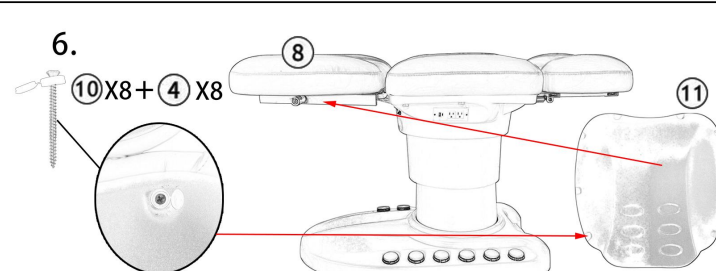
6.  **⑩ X8 + ④ X8**

Fix the bottom shell of ⑪ at the bottom of ⑧

Align according to the hole positions, and then fix the reserved positions with numbers ⑩ and ④ on the backpack in sequence

7.  **⑩ X5 + ③ X5**

Fix the bottom shell of ⑫ at the bottom of ⑨



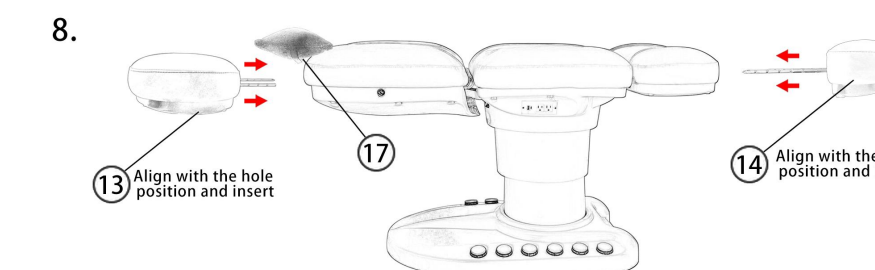



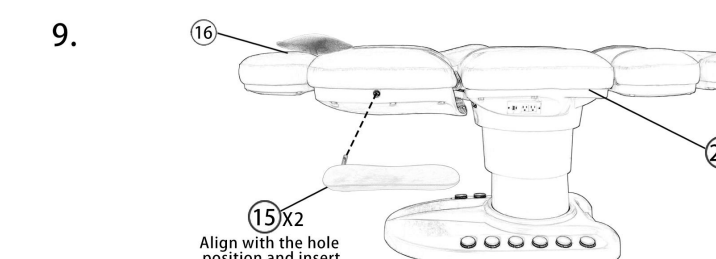



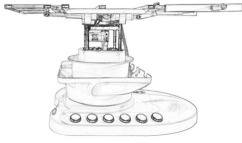

Align according to the hole positions, and then fix the reserved positions with numbers ⑩ and ③ on the backpack in sequence

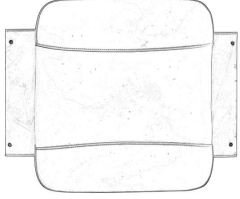
8.  **⑬** Align with the hole position and insert

**⑭** Align with the hole position and insert

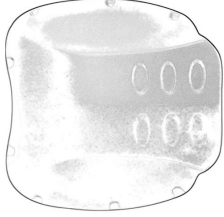
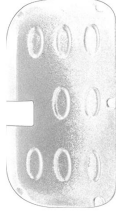
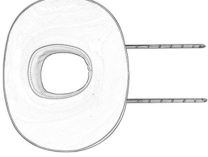
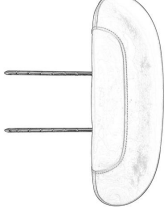
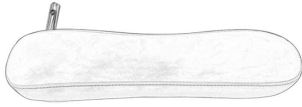
9.  **⑮ X2**

Align with the hole position and insert

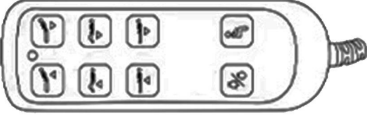
 <p>① X5+1</p>	 <p>②</p>	 <p>③ 4X50 13 Piece+2</p>	 <p>④ 4X70 8 Piece+1</p>	 <p>⑤ 8X20 2 Piece+1</p>	 <p>⑥ 8X40 10 Piece+1</p>
 <p>⑦</p>	 <p>⑧</p>	 <p>⑨</p>	 <p>⑩ 21 Piece+4</p>		
 <p>⑪</p>	 <p>⑫</p>	 <p>⑬</p>	 <p>⑭</p>		
 <p>⑮ X2</p>	 <p>⑯</p>	 <p>⑰</p>			
 <p>⑱</p>	 <p>⑲</p>	 <p>⑳</p>			