











Assembly Instructions

Caution: You must read this before you proceed

Care & Maintenance





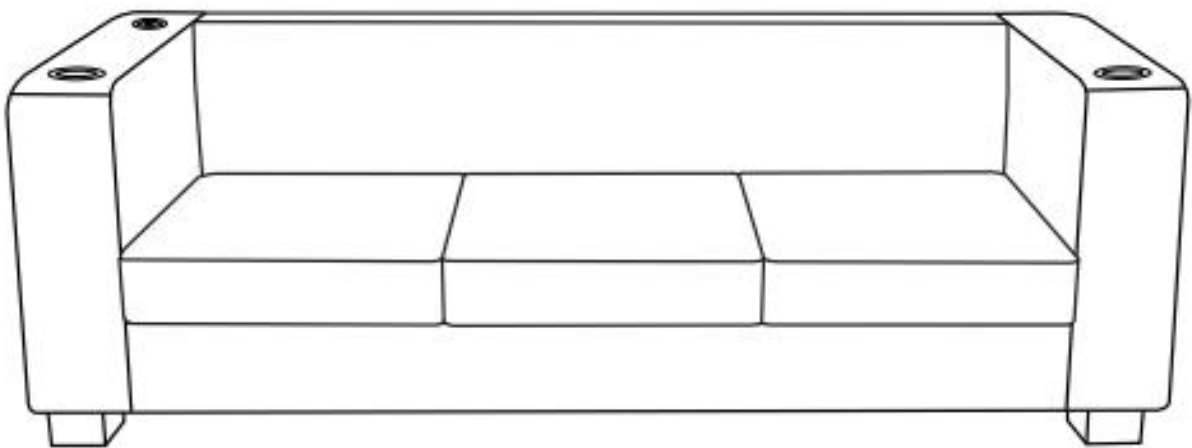

	<ul style="list-style-type: none">● Not for commercial use. For residential use only.
	<ul style="list-style-type: none">● Furniture may scratch floors. We recommend using furniture pads to protect your floors.
	<ul style="list-style-type: none">● Do not put hot items directly on furniture surface.
	<ul style="list-style-type: none">● Do not clean furniture with harsh cleansers or polish.
	<ul style="list-style-type: none">● Do not place furniture under direct sunlight.
	<ul style="list-style-type: none">● Do not place furniture near heating or cooling vents.
	<ul style="list-style-type: none">● Do not write on furniture without a padded barrier to protect the surface.
	<ul style="list-style-type: none">● Do not place furniture outside . For indoor use only.
	<ul style="list-style-type: none">● Stains may be removed with mild soap solution and damp cloth.
	<ul style="list-style-type: none">● Children should not climb or jump on the furniture.
	<ul style="list-style-type: none">● Dust and pick-up spills using a clean, non-colored, lint-free cloth.

Please look in the magic tape pouch for hardware packs and legs

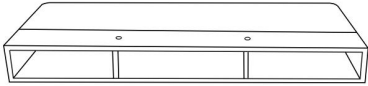

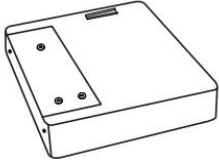
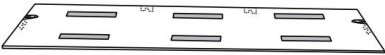
SOFA

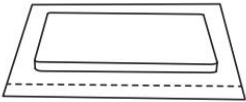

Part List

Label	Picture	Description	QTY
A		Backrest	1
B		Left Armrest	1
C		Right Armrest	1
D		Seat	1
E		Front Rail	1
F		Seat Cushion Package	3
G		Leg	4
H		Power Cord	1

Hardware List

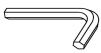
Label	Picture	Description	QTY
①		Bolt(M8*60MM)	5
②		Flat Washer Ring	5
③		Spring Washer Ring	5
④		Allen Wrench	1

Assembly Preparation

Before Beginning Assembly:

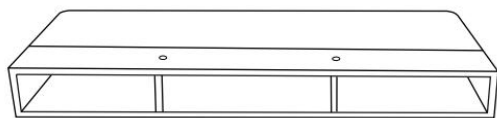

AX1



BX1



CX1



DX1



EX1



FX3



GX4



HX1



M8*60MM
X5



M8
X5



M8
X5

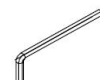

S5
X1



- Read instructions, cover to cover-



- Have 2 adults on hand for assembly-



- Do not assemble on flooring or carpet-



- Assemble on a clean non-marring surface (packing foam)-



- Save all packaging until finished-

Assembly Steps

OVERVIEW

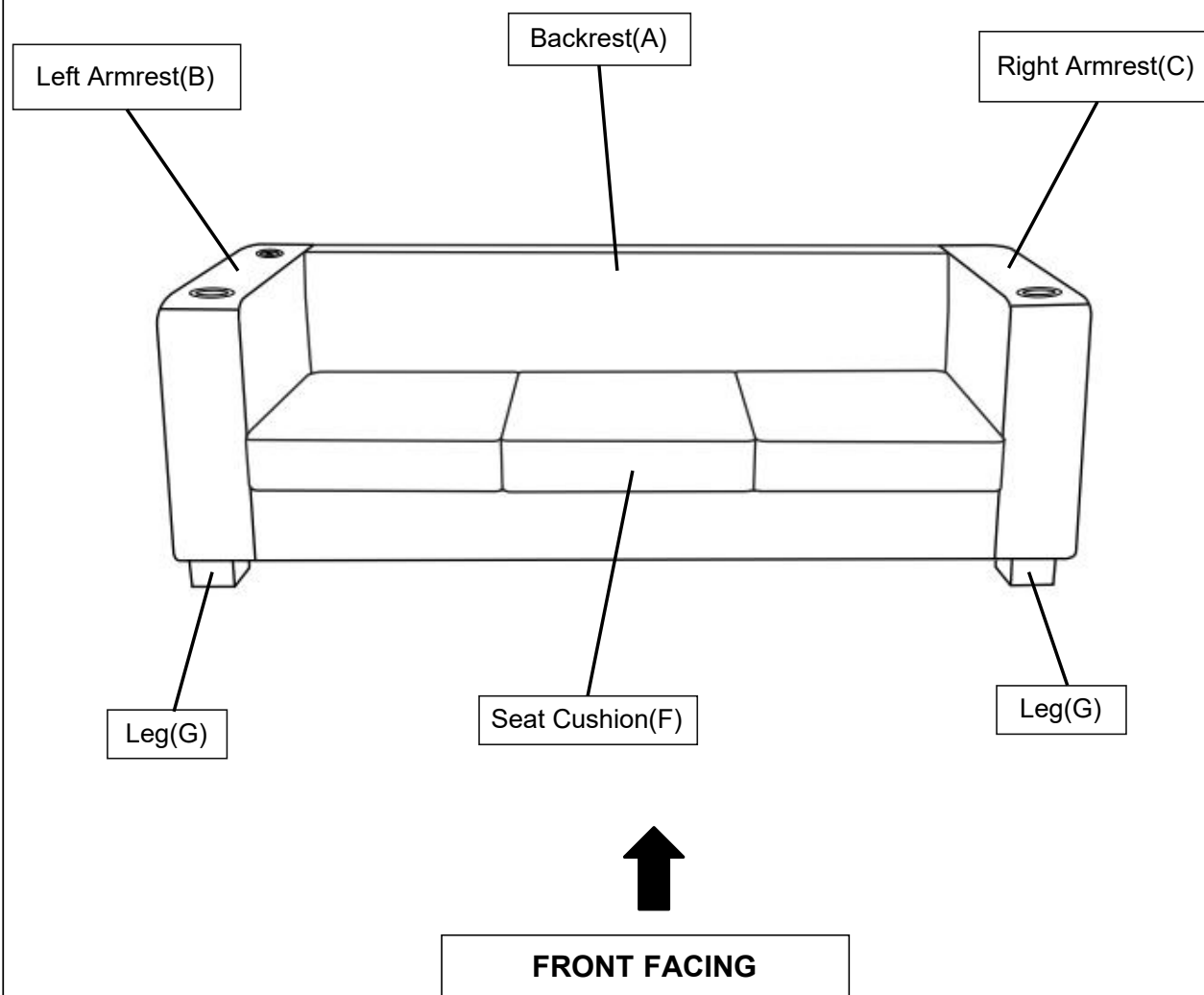

This Sofa has multiple parts and may require up to 60 minutes to assemble. To give you an overview of the Sofa parts, the above picture is to help you put the various parts into perspective. Please read through the instructions below to familiarise yourself with the parts and steps before assembly.

Note: It is recommended that you have an adult partner to assist during the entire assembly process.

Step 1

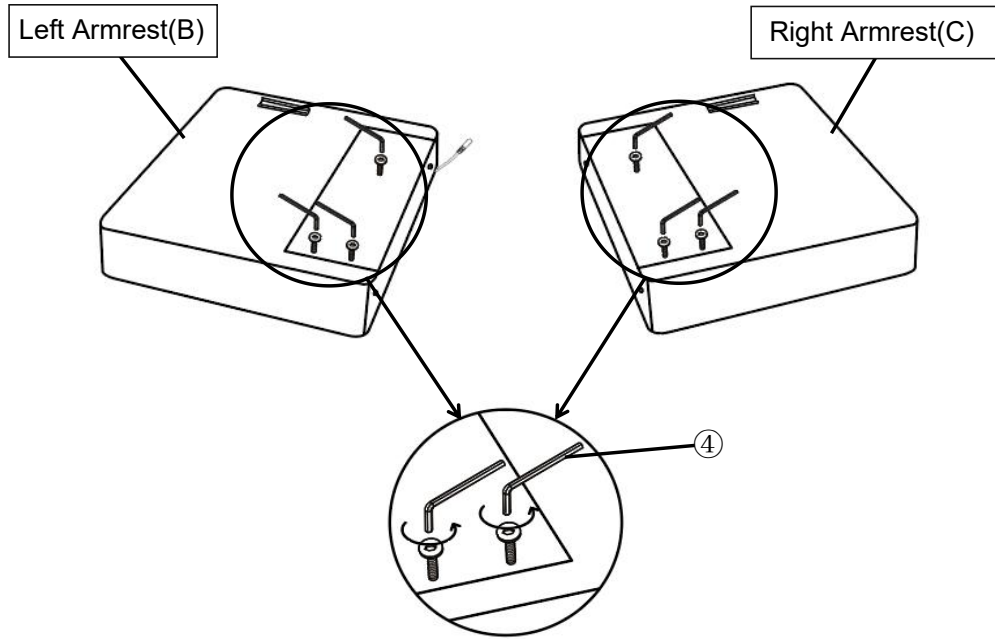

Loosen the 3 bolts in Left Armrest(B) around half inch by Allen Wrench(④).
Repeat the same step to loosen 3 bolts in Right Armrest(C).

Step 2

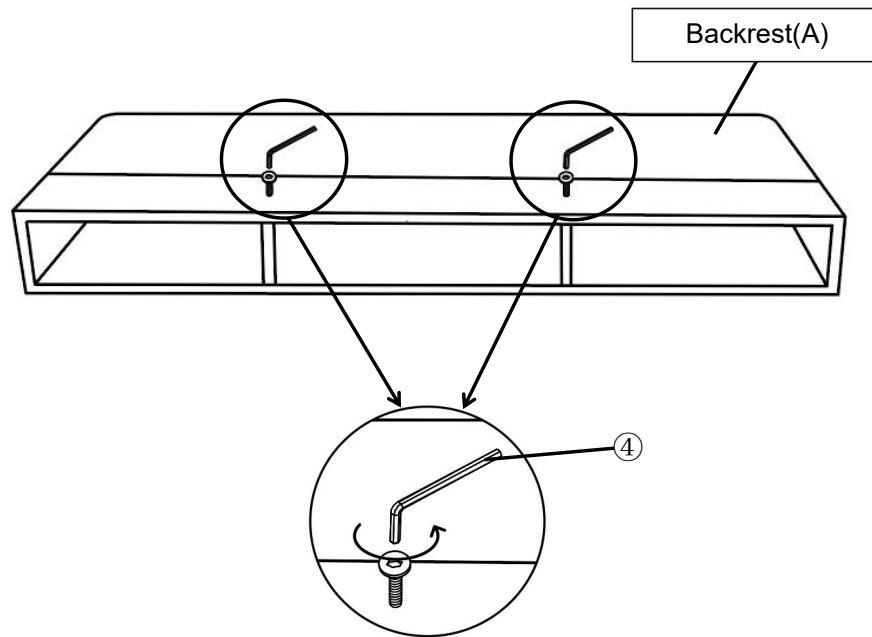

Loosen the bolt in Backrest(A) around half inch by Allen Wrench(④).

Step 3

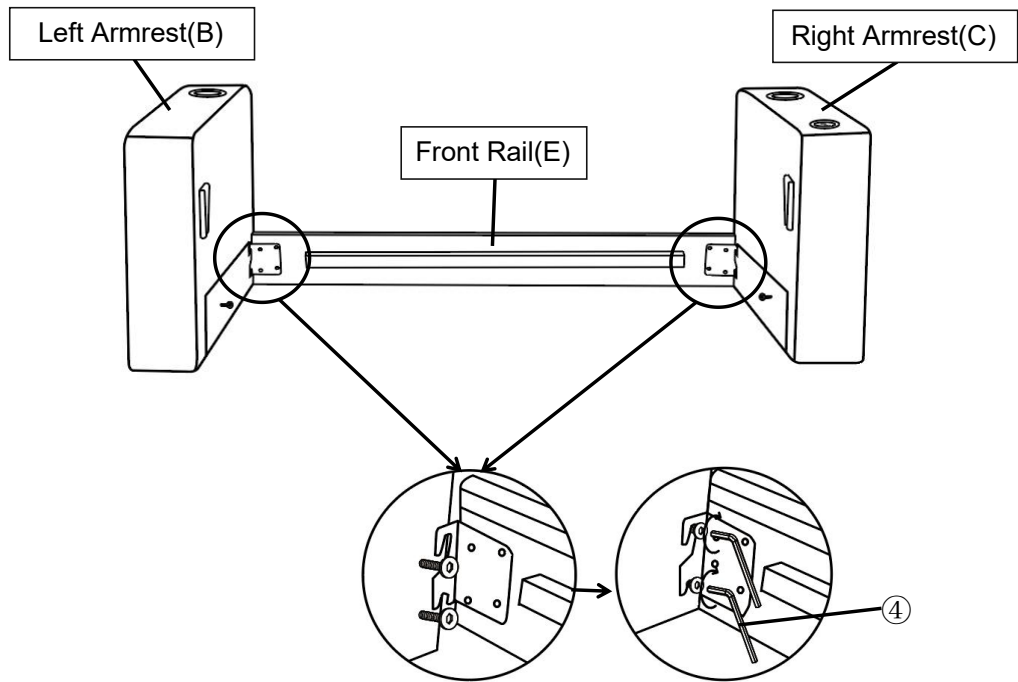

With the assistance of your partner, slide the hook in the end of Front Rail (E) into the bolts on the Left Armrest (B) and Right Armrest (C), as shown in Picture. Tighten the Bolts with Allen Wrench (④).

Step 4

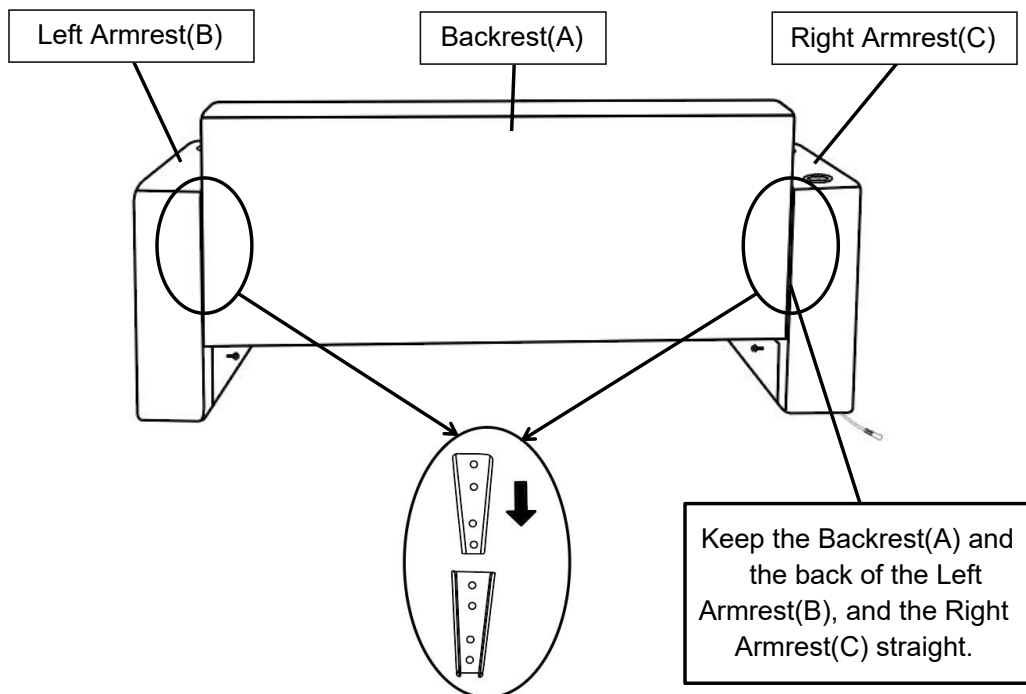

Slide the Tapered Connectors on the Backrest (A) into the Tapered Connectors on the Left Armrest (B) as shown in the picture.

Repeat the same step with the Right Armrest (C).

Note: Make sure the Tapered Connectors on the Backrest (A) lock into the Tapered Connectors on the Left Armrest (B) and the Right Armrest (C).

NOTE: Keep the Backrest (A) and the back of the Left Armrest (B), and the Right Armrest (C) flat. Assistance from an adult partner is necessary for this assembly process.

During this assembly process - do exercise caution. You may need to use your hand to press down and or pave away the padded surface to facilitate the 'slip and slide' assembly.

Caution: Ensure that your fingers do not get caught or pinched in the assembly process.

Step 5

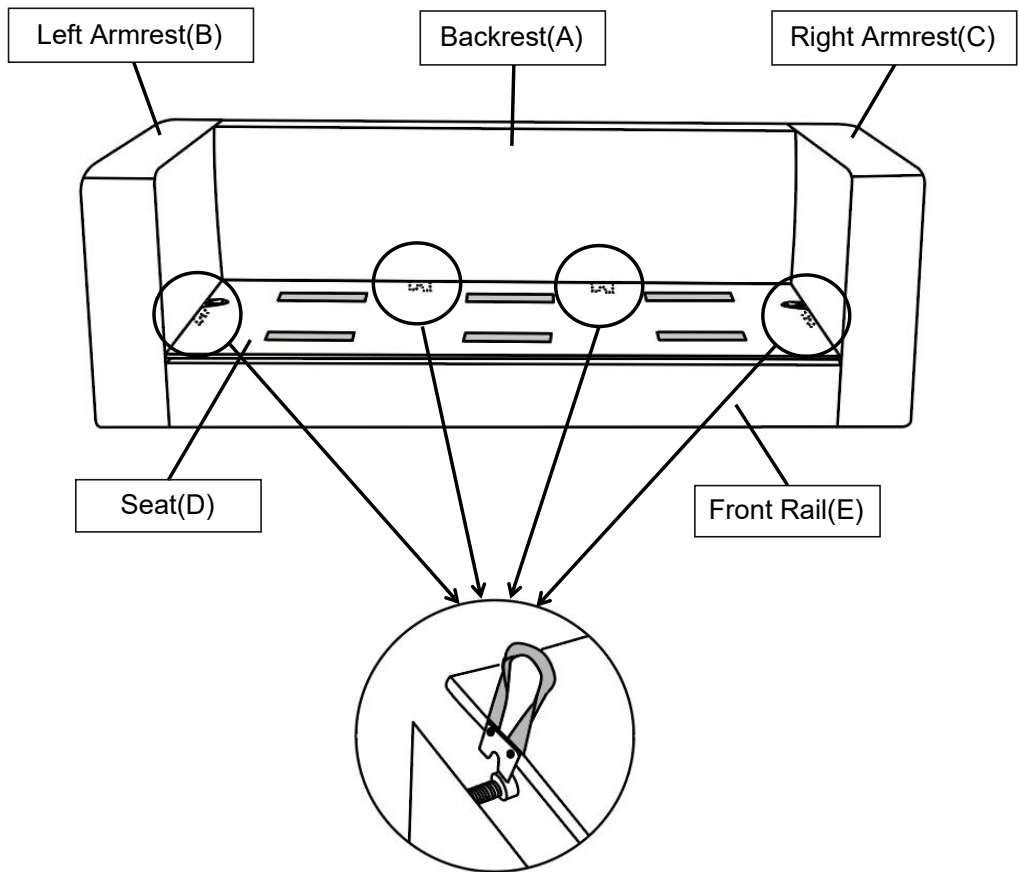

With the assistance of your adult partner, lift the rope on the two sides of Seat(D) by hand. Place the Seat(D) over the wooden bar on the back side of the Front Rail(E) and then slowly place it down on it as shown above.

Note: All the u-shaped iron sheets need to be clamped to the bolt.

Step 6

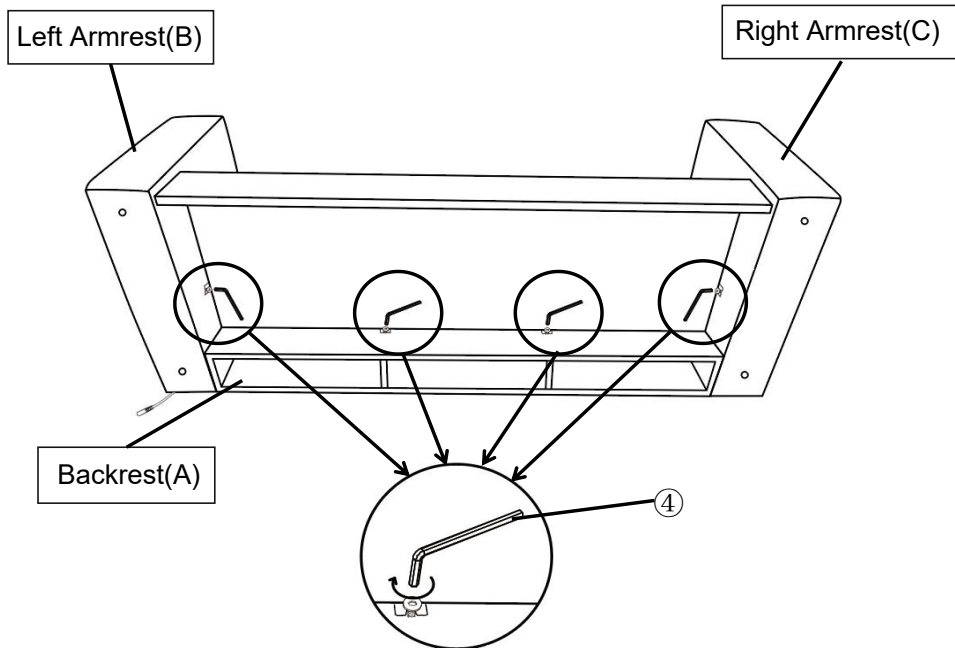

Tilt and lay the Sofa onto a flat surface.
 Tighten the Bolts in the bottom of Backrest(A), the Left Armrest(B) and the Right Armrest(C) by Allen Wrench(④) as pictured above.
 Tighten the Bolts fully in a sequential manner.

Step 7

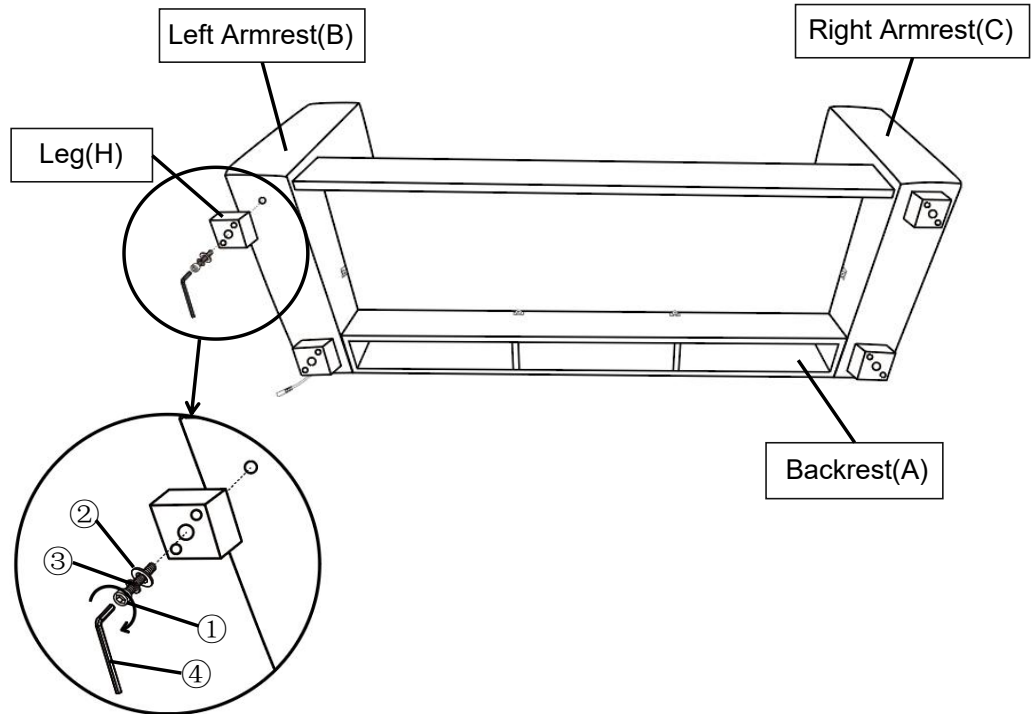

Install the Leg(H) to the Left Armrest(C) using a Bolt(①), a Spring Washer Ring(③), a Flat Washer Ring (②), with the Allen Wrench(④) turning clockwise until tight.
 Repeat the same step with the remaining Legs(H).

Step 8

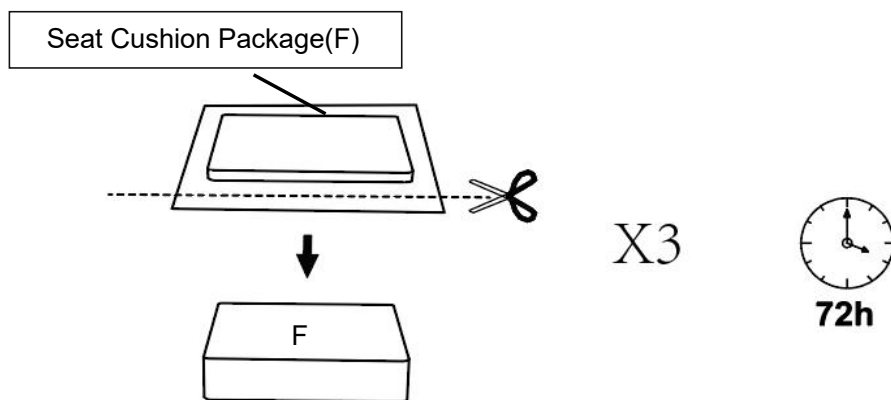

Cut the 3 pcs Seat Cushion Package(F), and remove 3 pcs Seat Cushion(F).
 Please be patient and wait for the cushion to return to its fluffy state, it might take up to 72 hours.

Step 9

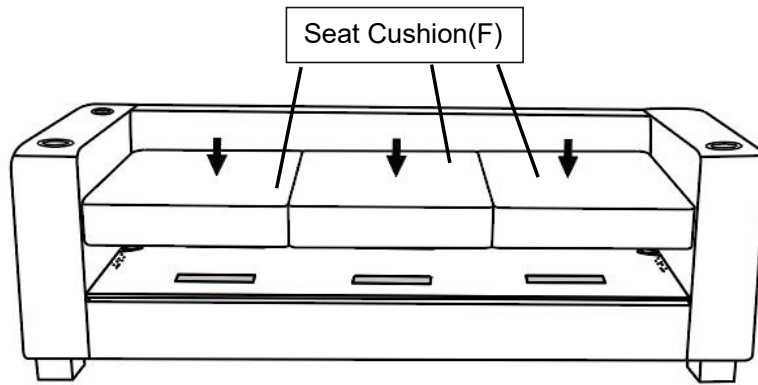

Place the Seat Cushions(F) on the Sofa.

Step 10

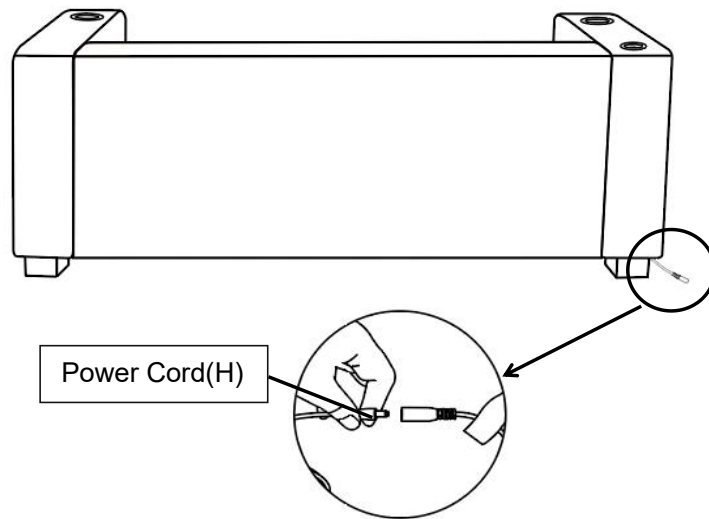

As shown in the picture, the Power Cord(H) can be used normally.

Step 11

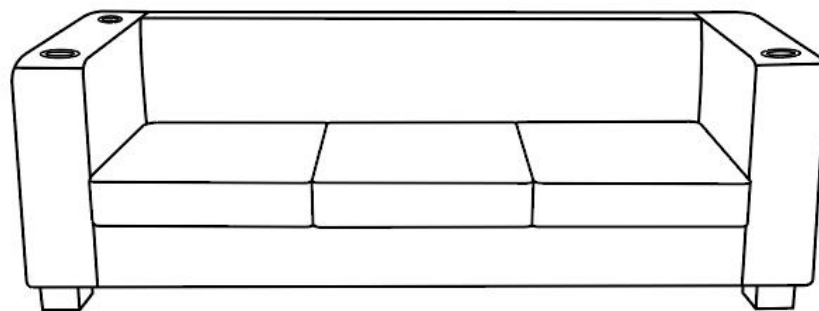

Your Sofa is ready for use.
This Sofa can only be used on a flat, level surface.