

ASSEMBLY INSTRUCTION

MF320584

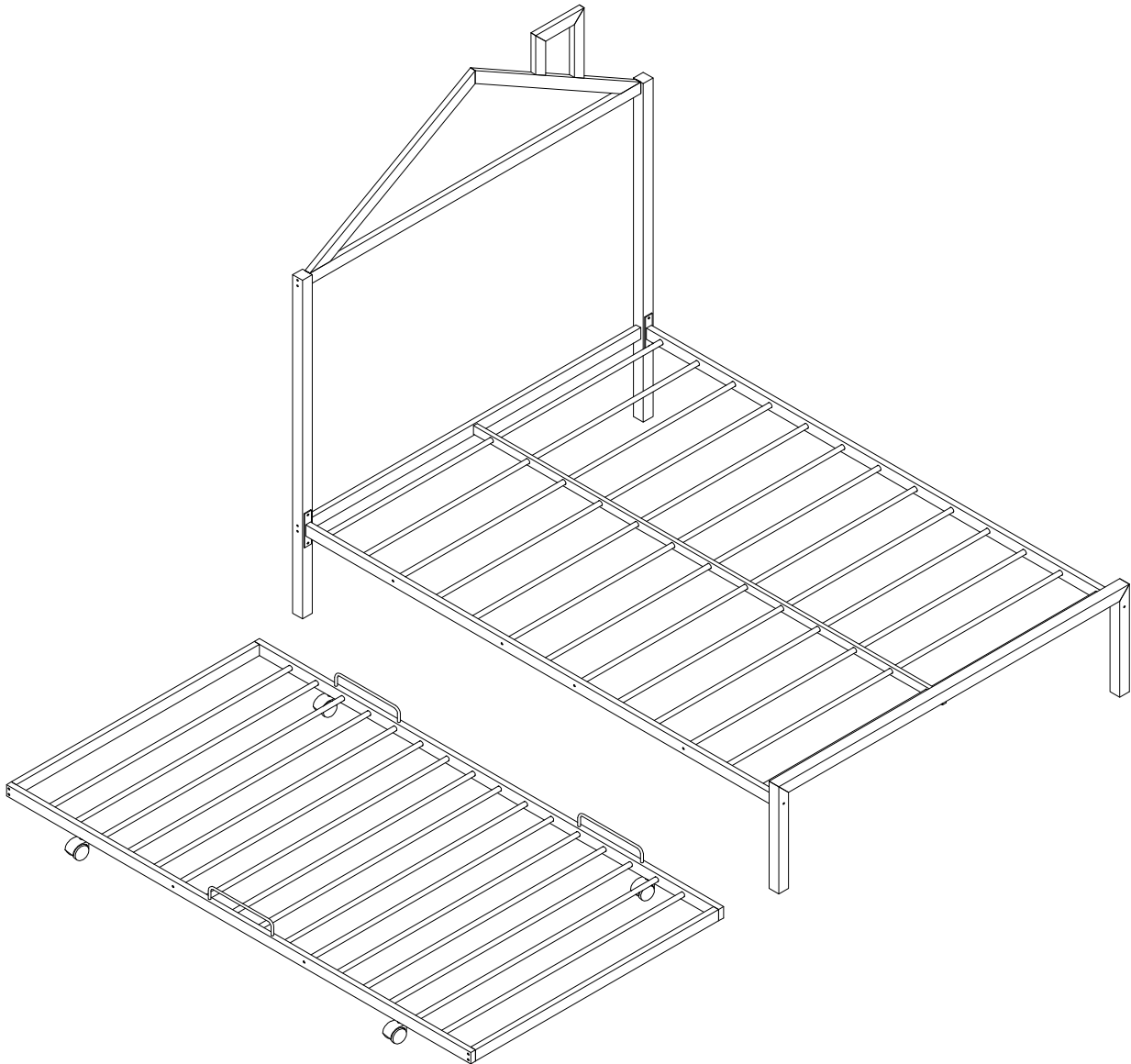

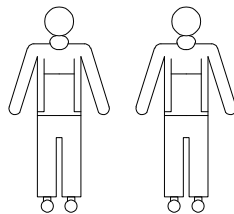

Minimum no. 2 of people
recommended to assemble
this product: Approx.
assembly time: 60 mins

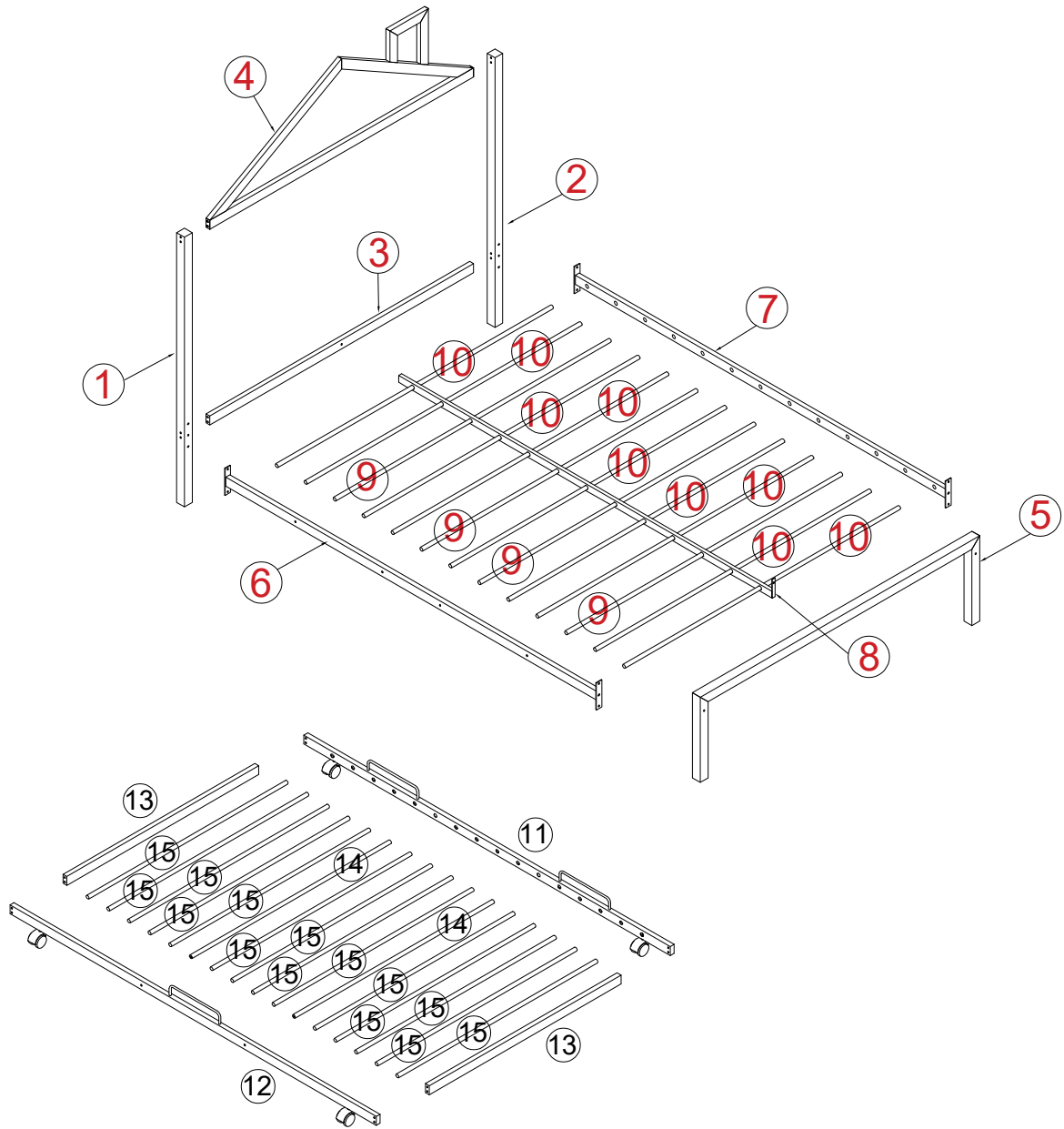





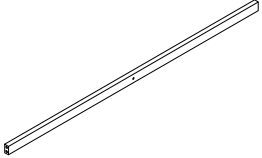
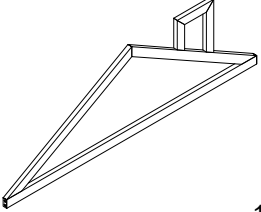
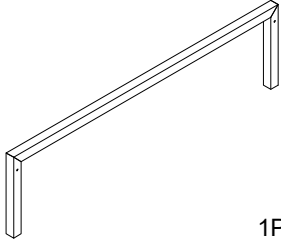
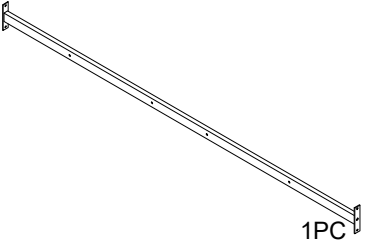
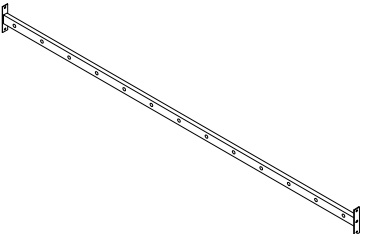
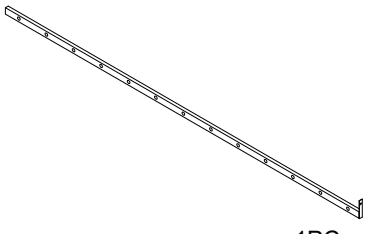
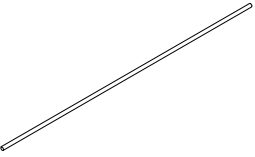
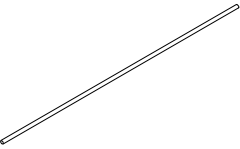
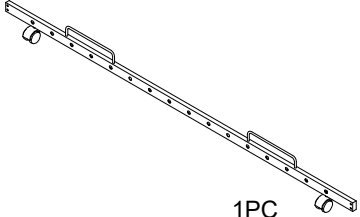
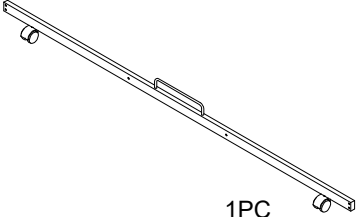
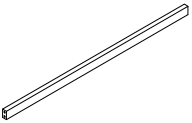
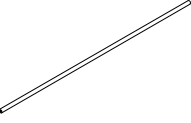
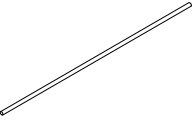



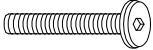

PART LIST MF320584

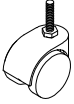
<p>1</p>  <p>1PC</p>	<p>2</p>  <p>1PC</p>	<p>3</p>  <p>1PC</p>
<p>4</p>  <p>1PC</p>	<p>5</p>  <p>1PC</p>	<p>6</p>  <p>1PC</p>
<p>7</p>  <p>1PC</p>	<p>8</p>  <p>1PC</p>	<p>9</p>  <p>4PCS</p>
<p>10</p>  <p>9PCS</p>	<p>11</p>  <p>1PC</p>	<p>12</p>  <p>1PC</p>
<p>13</p>  <p>2PCS</p>	<p>14</p>  <p>2PCS</p>	<p>15</p>  <p>14PCS</p>

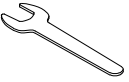
HARDWARE LIST MF320584

<p>A</p>  <p>12PCS M$\frac{1}{4}$"X55</p>	<p>B</p>  <p>9PCS M$\frac{1}{4}$"X35</p>	<p>C</p>  <p>21PCS M$\frac{1}{4}$"X15</p>	<p>D</p>  <p>4PCS #40x40x16</p>
<p>E</p>  <p>2PCS M8xØ50x70H</p>	<p>F</p>  <p>2PCS M8xØ50x70H</p>	<p>G</p>  <p>1PC M4X23X57</p>	<p>H</p>  <p>1PC 13mm</p>

STEP 1

A	D
	
M $\frac{1}{4}$ "x55	#40x40x16
8 PCS	2 PCS

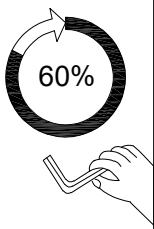
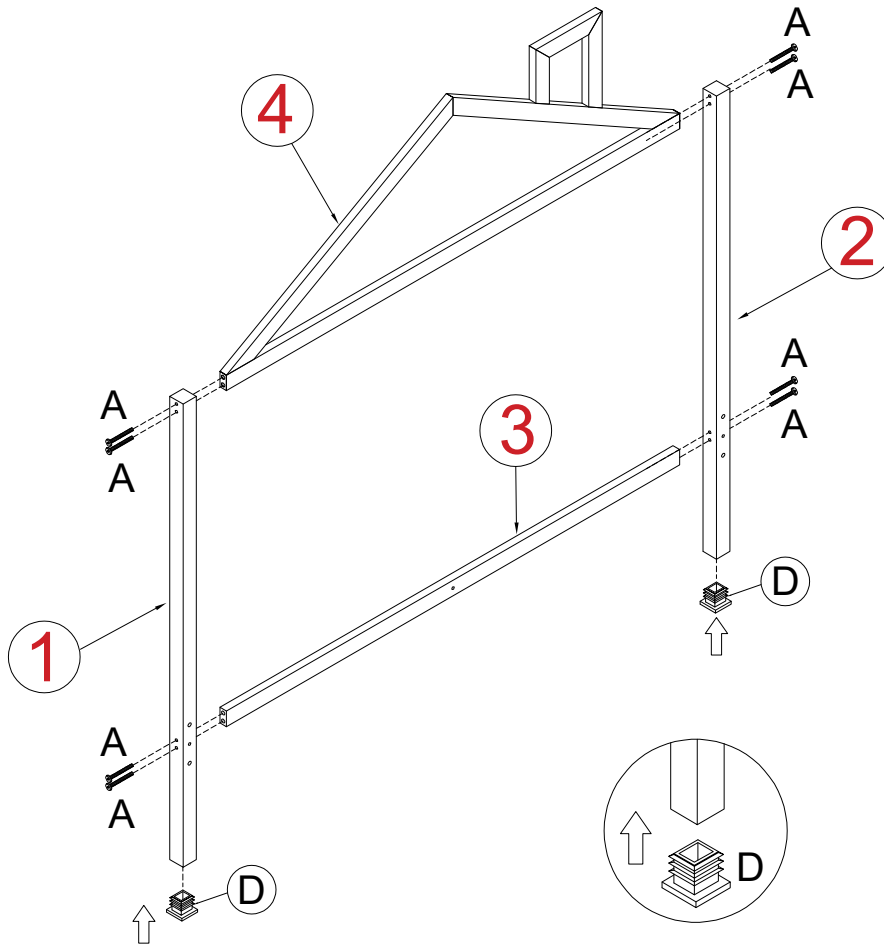



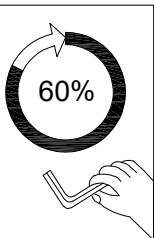
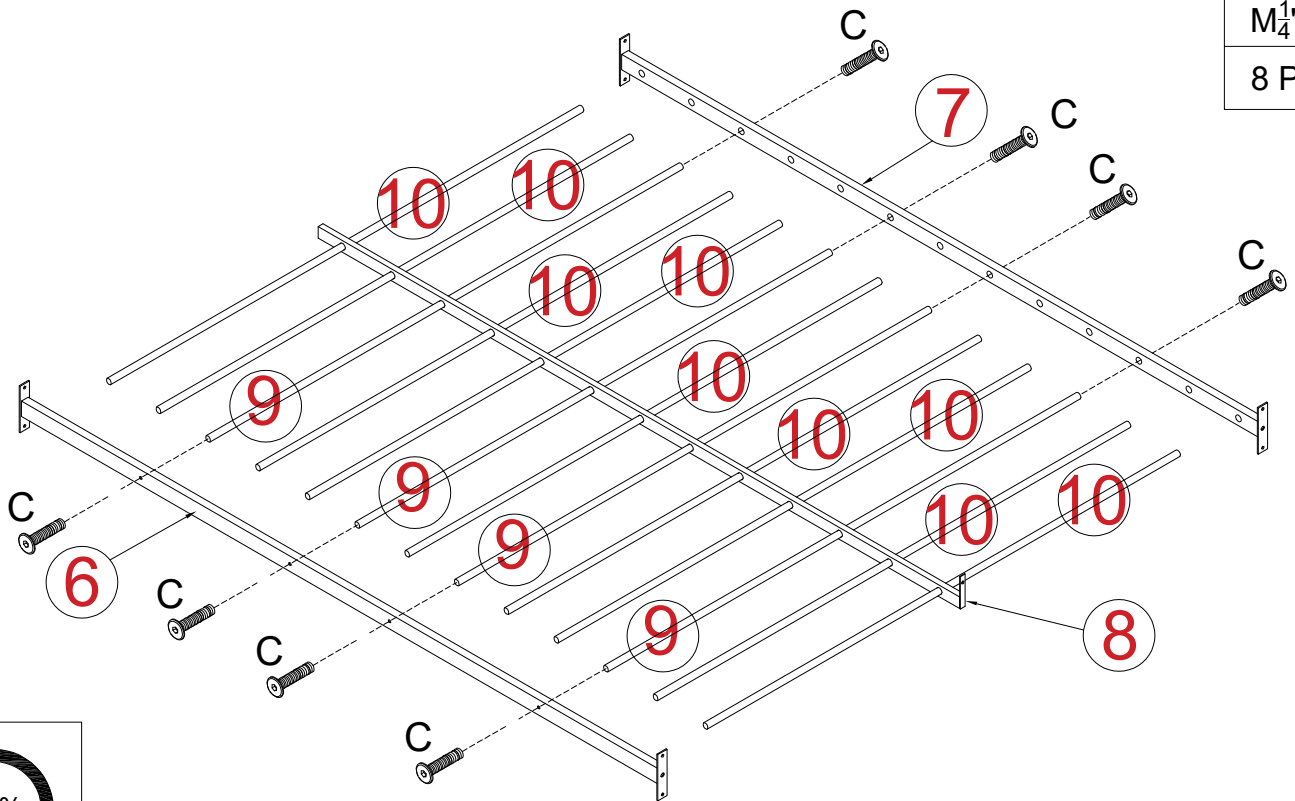

STEP 2

C

M $\frac{1}{4}$ "x15
8 PCS



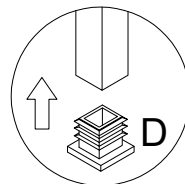
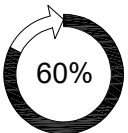
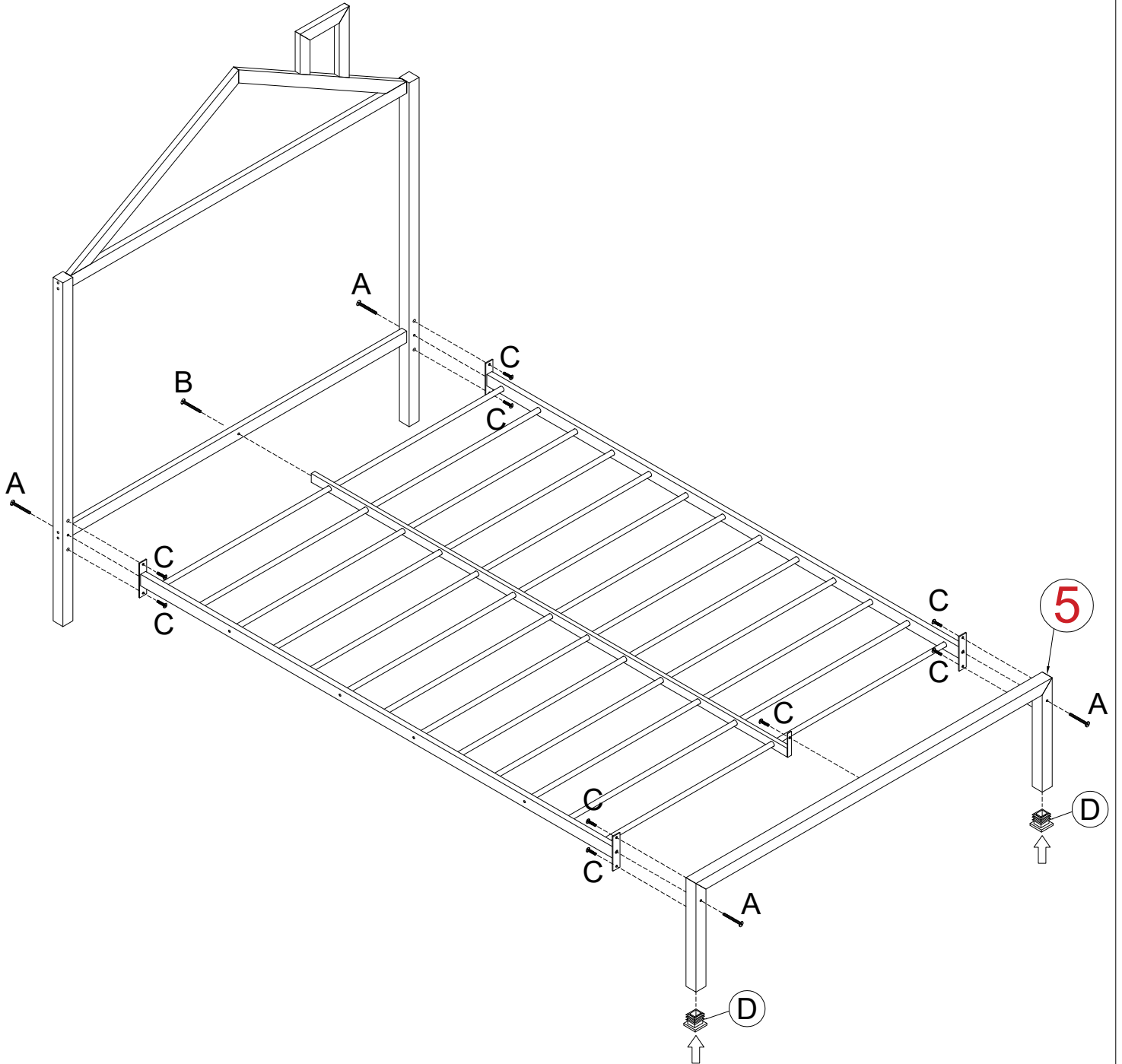

STEP 3

A	B	C	D
 M $\frac{1}{4}$ "x55	 M $\frac{1}{4}$ "x35	 M $\frac{1}{4}$ "x15	 #40x40x16
4 PCS	1 PC	9 PCS	2 PCS



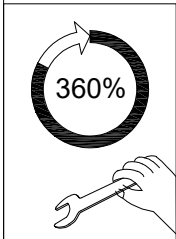
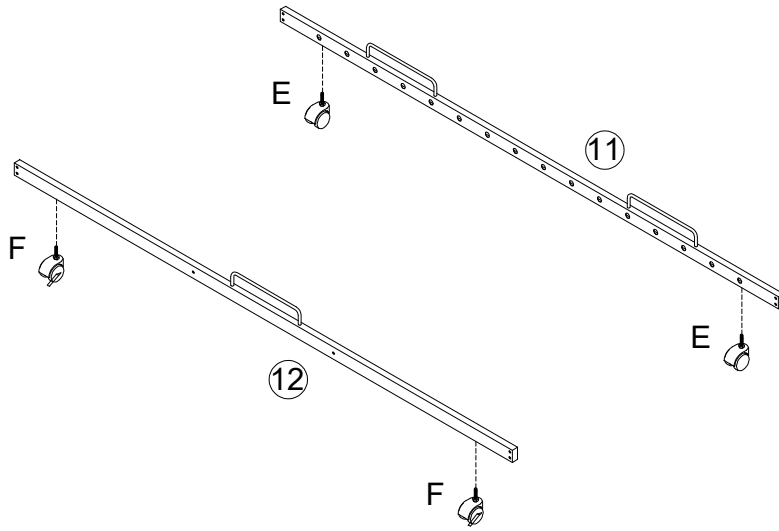

STEP 4

E	F
 M $\frac{5}{16}$ "xØ50x70H	 M $\frac{5}{16}$ "xØ50x70H
2 PCS	2 PCS



STEP 5

B	C
 M $\frac{1}{4}$ "x35	 M $\frac{1}{4}$ "x15
8 PCS	4 PCS

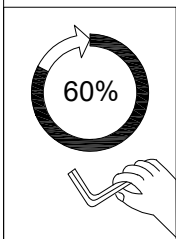
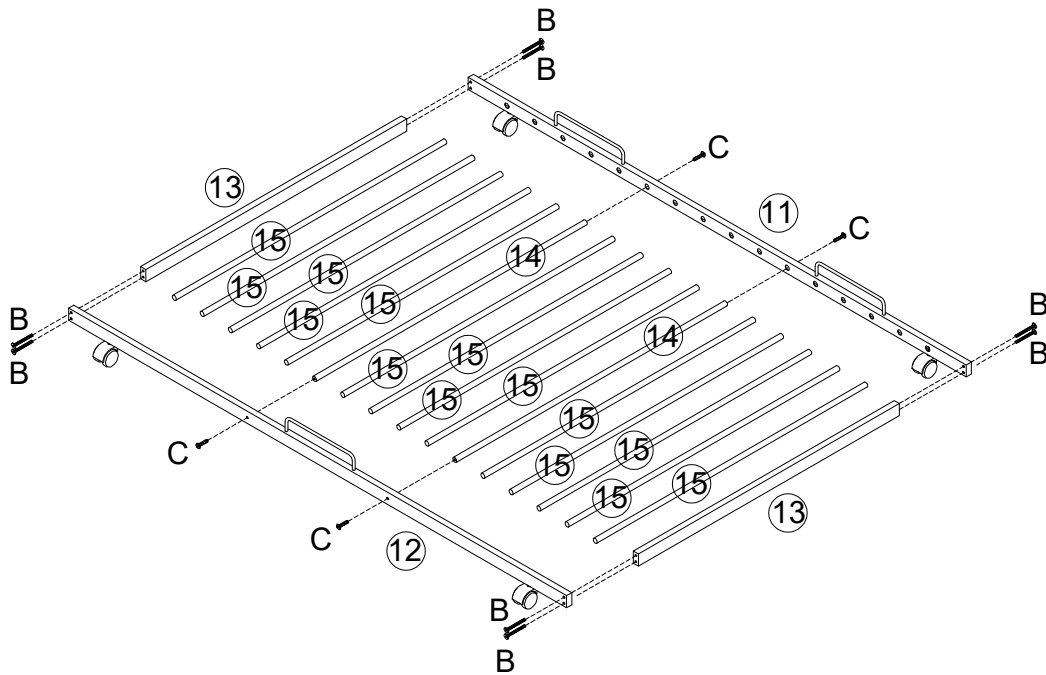

STEP 6

