

ASSEMBLY INSTRUCTION

TABLE

TABLE DE SALLE À MANGER

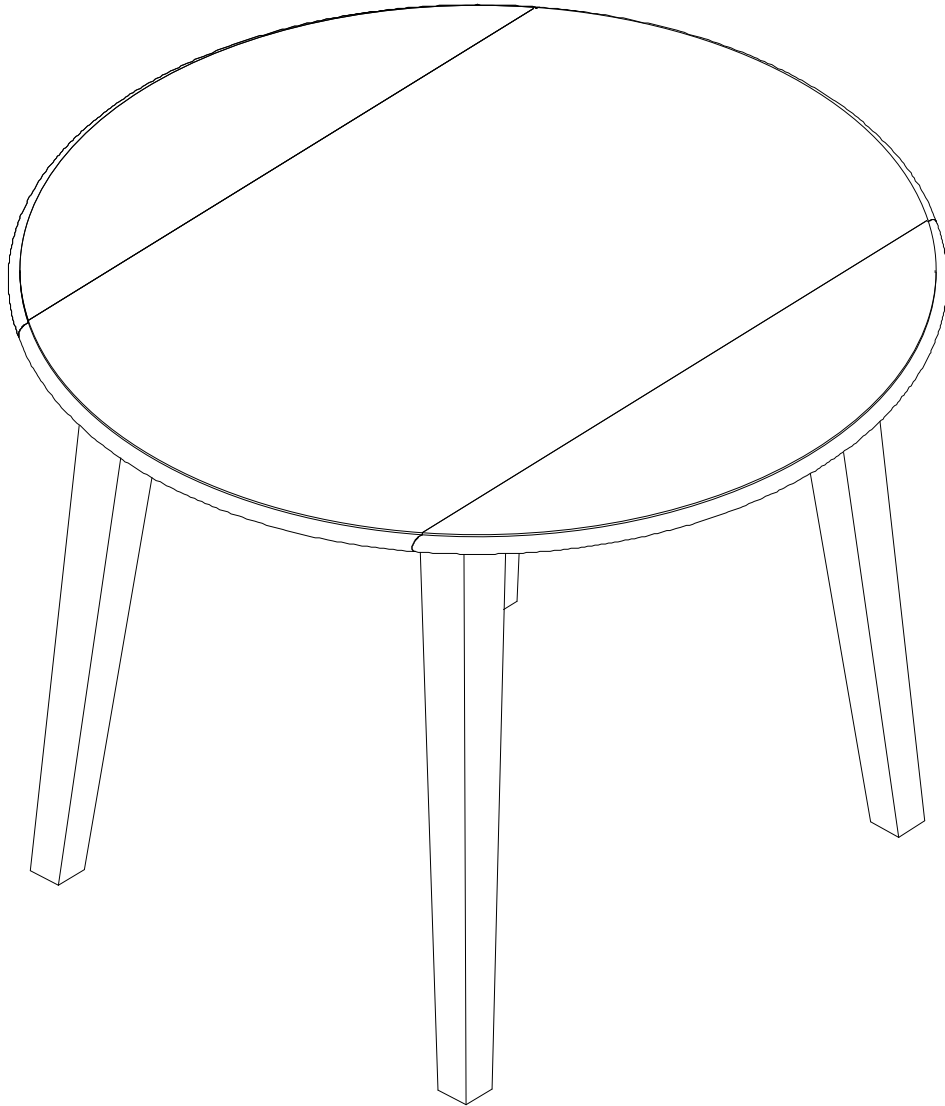



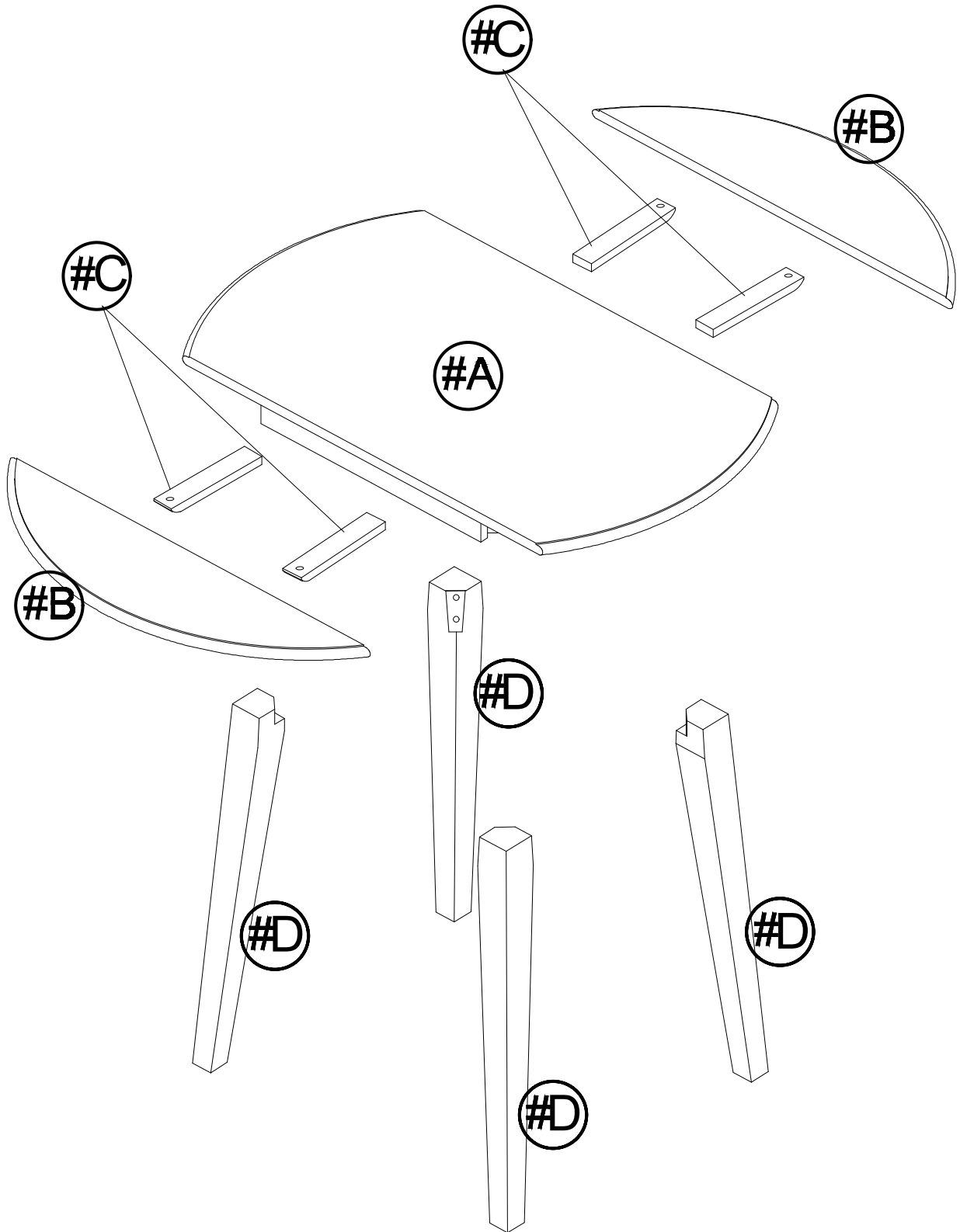

Detail View
(Vue détaillée)

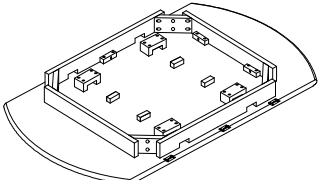
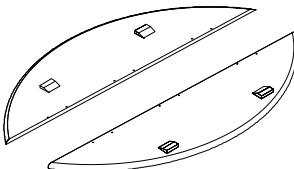
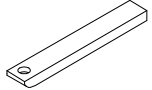
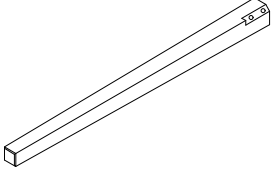

Part List : (Liste des pièces)

<div style="border: 1px solid black; padding: 5px; width: 40px; margin-bottom: 5px; text-align: center; font-weight: bold;">A</div>  <p style="text-align: center;">Table top-1pc Plateau de table -1pc</p>	<div style="border: 1px solid black; padding: 5px; width: 40px; margin-bottom: 5px; text-align: center; font-weight: bold;">B</div>  <p style="text-align: center;">Leaf -2pcs Rallonge de table - 2pcs</p>	<div style="border: 1px solid black; padding: 5px; width: 40px; margin-bottom: 5px; text-align: center; font-weight: bold;">C</div>  <p style="text-align: center;">Support bar - 4pcs Barre de renfort - 4pcs</p>
<div style="border: 1px solid black; padding: 5px; width: 40px; margin-bottom: 5px; text-align: center; font-weight: bold;">D</div>  <p style="text-align: center;">Legs - 4pcs Pied de table - 4pcs</p>		

Hardware List: (Liste du matériel)

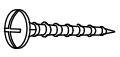
<div style="border: 1px solid black; padding: 5px; width: 40px; margin-bottom: 5px; text-align: center; font-weight: bold;">1</div>  <p style="text-align: center;">Ø5/16" x 55mm Bolt=8pcs Boulon =8pcs</p>	<div style="border: 1px solid black; padding: 5px; width: 40px; margin-bottom: 5px; text-align: center; font-weight: bold;">2</div>  <p style="text-align: center;">Ø5/16" Lock Washer =8pcs Rondelle élastique =8pcs</p>	<div style="border: 1px solid black; padding: 5px; width: 40px; margin-bottom: 5px; text-align: center; font-weight: bold;">3</div>  <p style="text-align: center;">Ø5/16" Flat washers =8pcs Rondelles plates =8pcs</p>
<div style="border: 1px solid black; padding: 5px; width: 40px; margin-bottom: 5px; text-align: center; font-weight: bold;">4</div>  <p style="text-align: center;">K4mm Allen key - 1pc clé Allen -1pc</p>	<div style="border: 1px solid black; padding: 5px; width: 40px; margin-bottom: 5px; text-align: center; font-weight: bold;">5</div>  <p style="text-align: center;">#3.5 x 15mm Screw =12pcs Vis =12pcs</p>	

PLEASE BE CAREFUL DO NOT DAMAGE THE HOLE POSITION WHEN YOU USE POWER TOOLS !
(FAITES ATTENTION À NE PAS ENDOMMAGER LA POSITION DU TROU LORSQUE VOUS UTILISEZ DES OUTILS ÉLECTRIQUES !)

STEP 1:
(ÉTAPE 1)

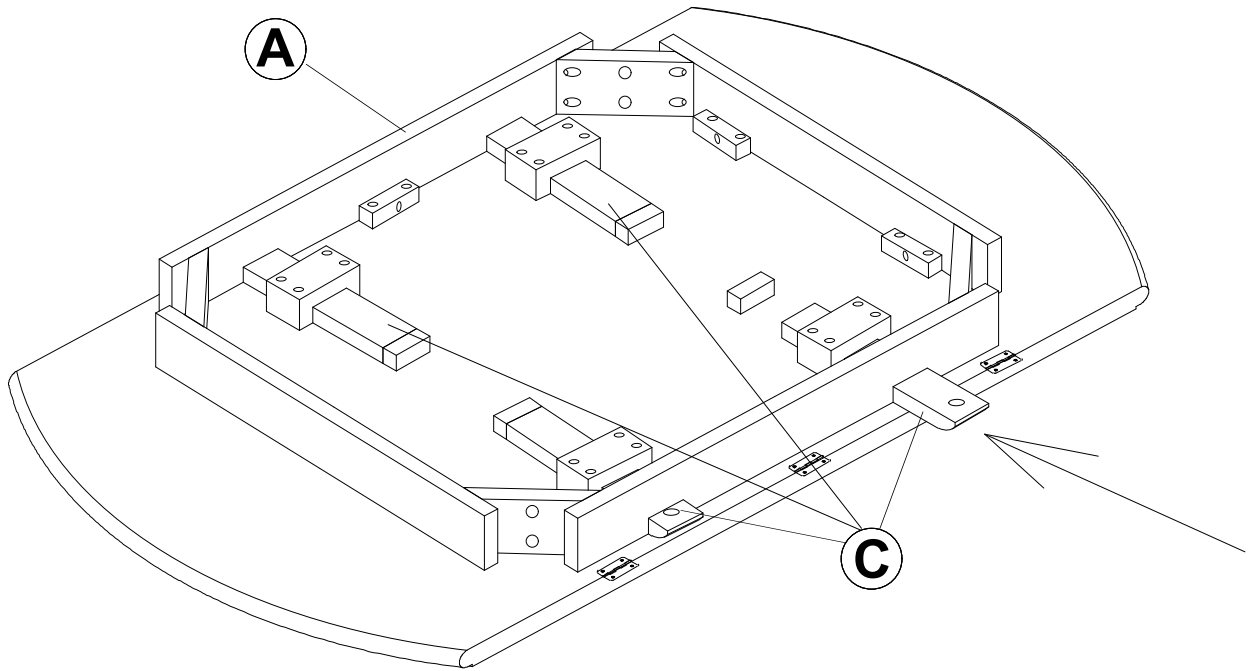



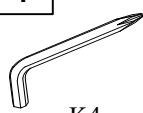

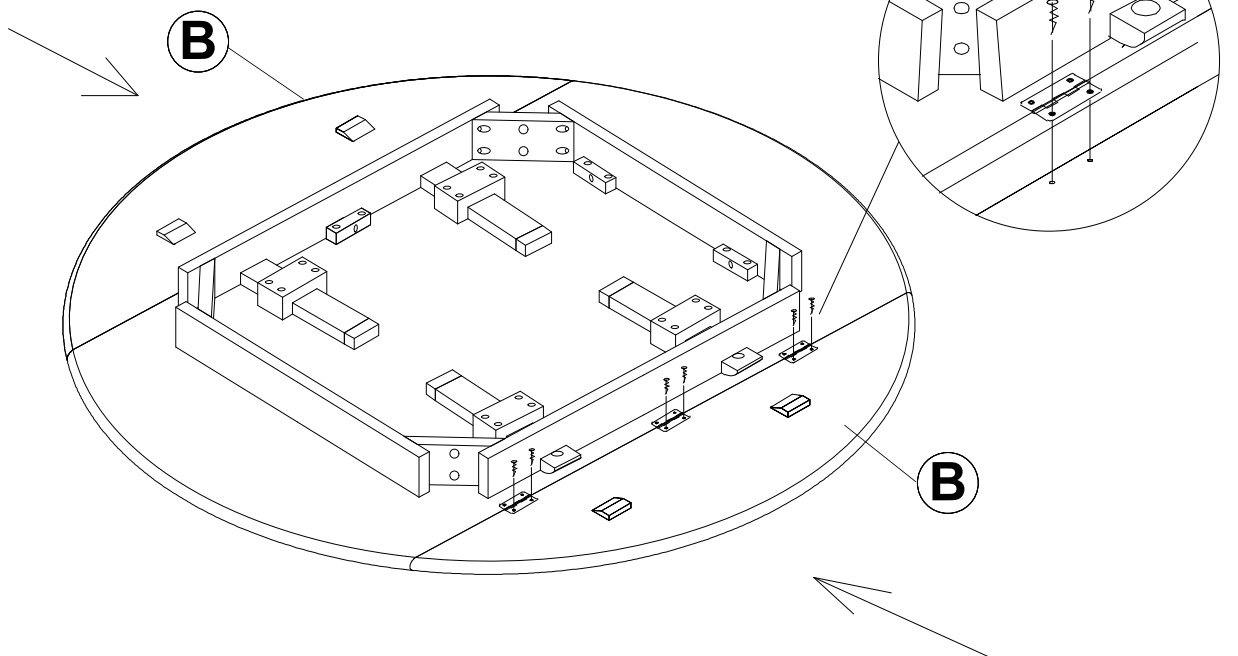
STEP 2:
(ÉTAPE 2)

5	4
	
#3.5 x 15mm 12pcs	K4 1pc

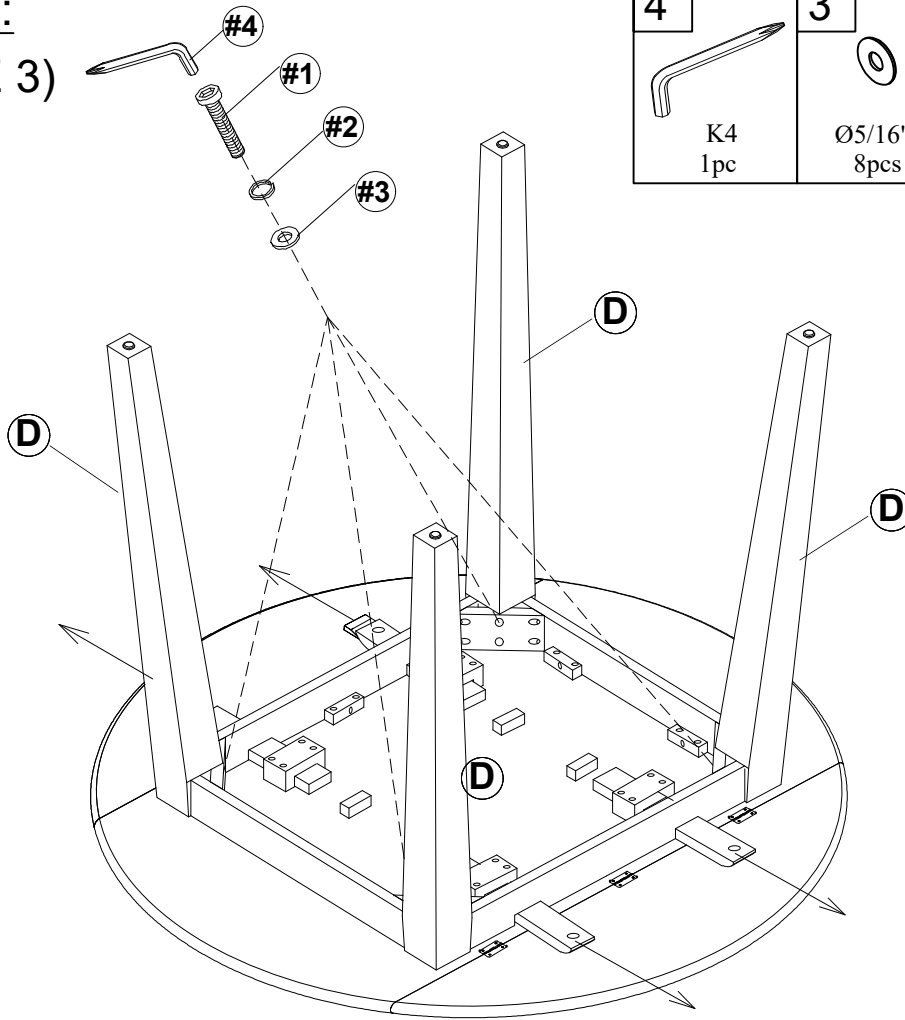

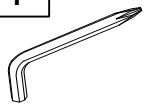
STEP 3:
(ÉTAPE 3)



4  K4 1pc	3  Ø5/16" 8pcs	2  Ø5/16" 8pcs	1  Ø5/16"x55mm 8pcs
--	---	---	--

STEP 4:
(ÉTAPE 4)

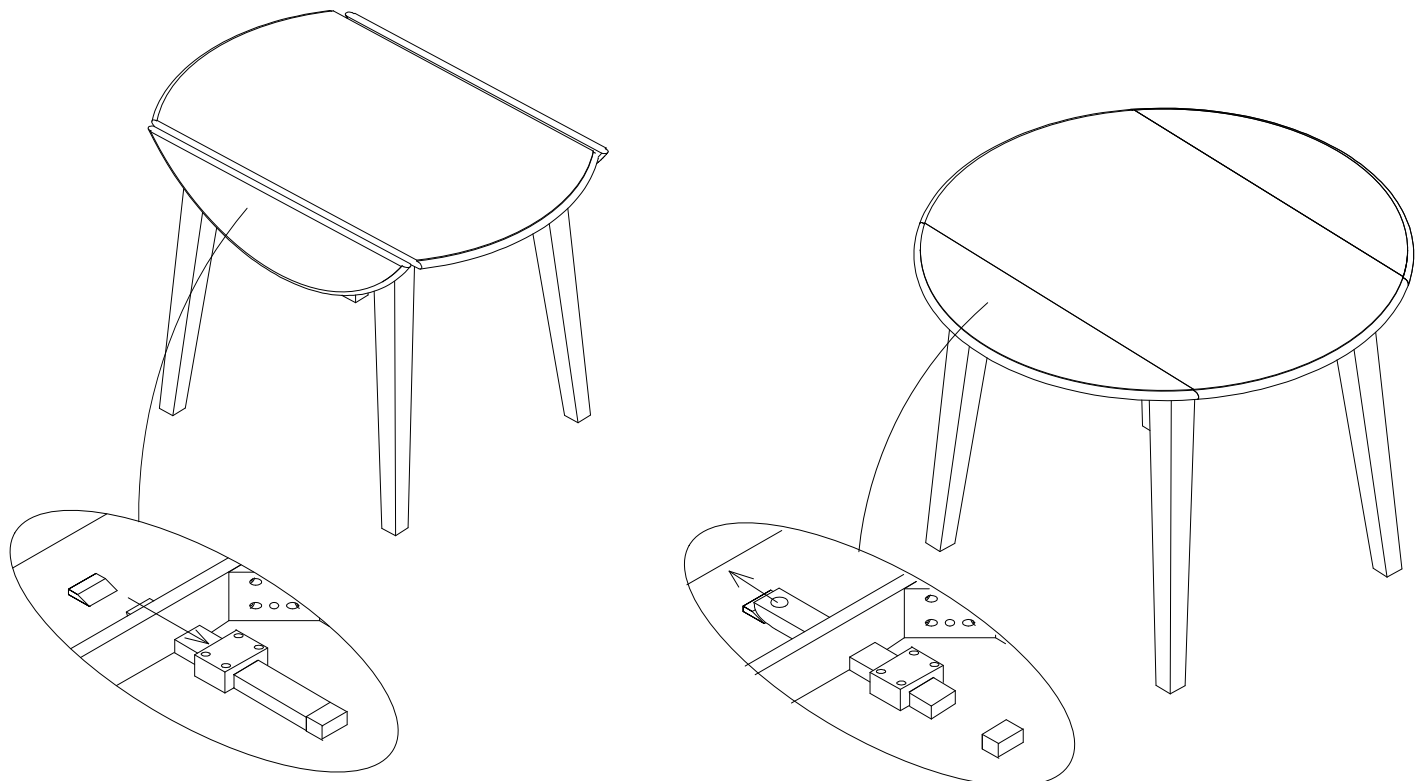

STEP 5:
(ÉTAPE 5)

COMPLETED ASSEMBLY

