

# Shower Base

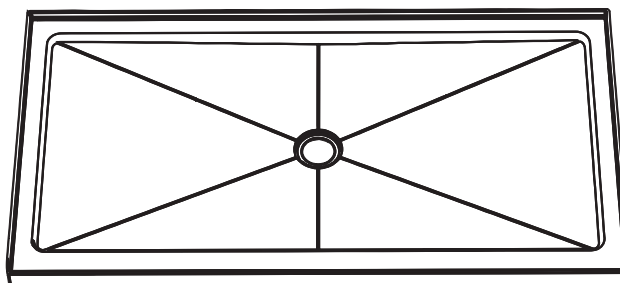

**PACKAGE CONTENTS**

PART	DESCRIPTION	QUANTITY
1	Solid Surface Shower Base	1
2	Stainless Steel Drain	1

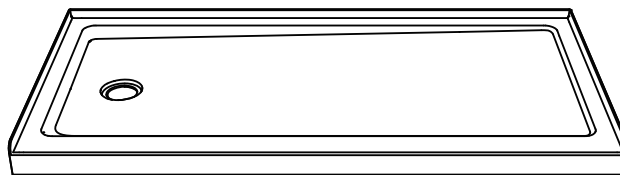
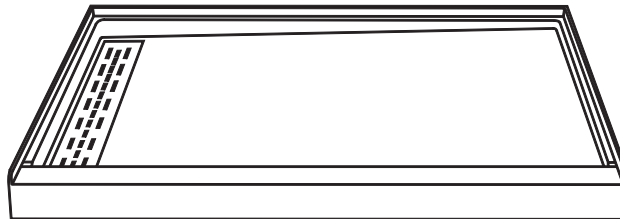
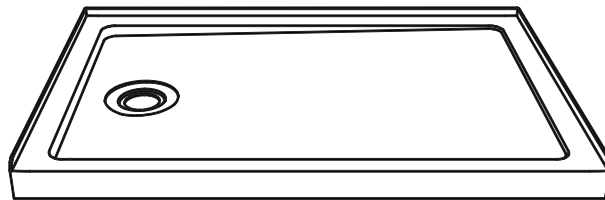
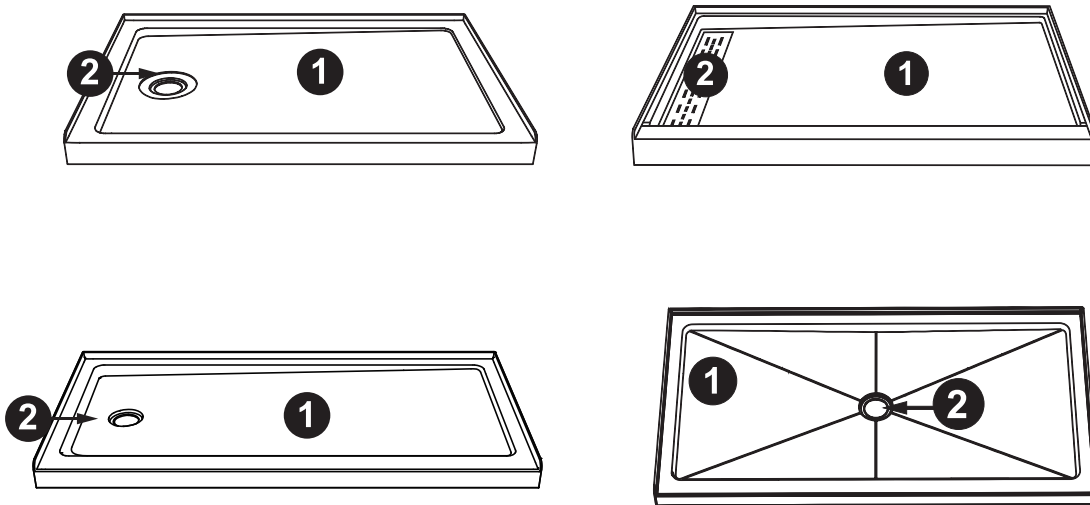

**SHOWER FLOOR & DRAIN OPENING - CONSTRUCTION DIMENSIONS**

We can not anticipate every possible installation situation or condition. The variety of installations possible for this shower floor may require procedures other than those shown. Plan ahead to ensure that wall framework construction is correctly sized, plumb, and square.

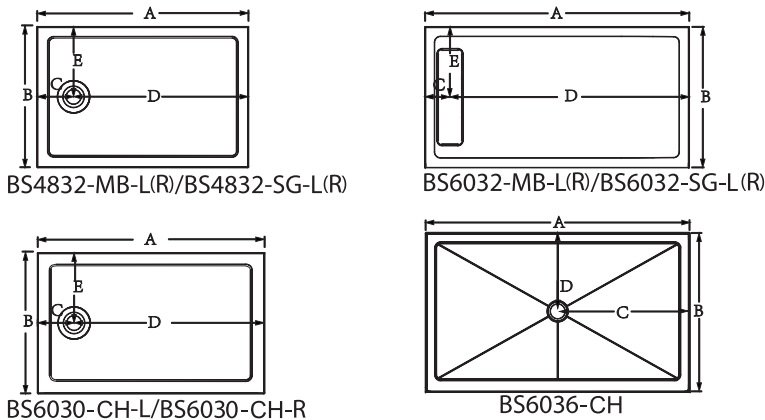

ITEM:	Dim. A	Dim. B	Dim. C	Dim. D	Dim. E
BS4832-MB-L/BS4832-SG-L	48"	32"	8.27"	39.73"	15.87"
BS4832-MB-R/BS4832-SG-R	48"	32"	8.27"	39.73"	15.87"
BS6032-MB-L/BS6032-SG-L	60"	32"	5.75"	54.25"	15.71"
BS6032-MB-R/BS6032-SG-R	60"	32"	5.75"	54.25"	15.71"
BS6036-CH	60"	36"	29.92"	17.72"	/
BS6030-CH-L/BS6030-CH-R	60"	30"	8.27"	51.73"	14.39"

\*Measurements are ± 1/8" and subject to change without notice

\* Make sure the drain hole in the subfloor or slab is large enough (6" diameter recommended) and aligns with the hole in the shower floor.

## INSTRUCTIONS

### (1) SUGGESTED TOOLS AND MATERIALS

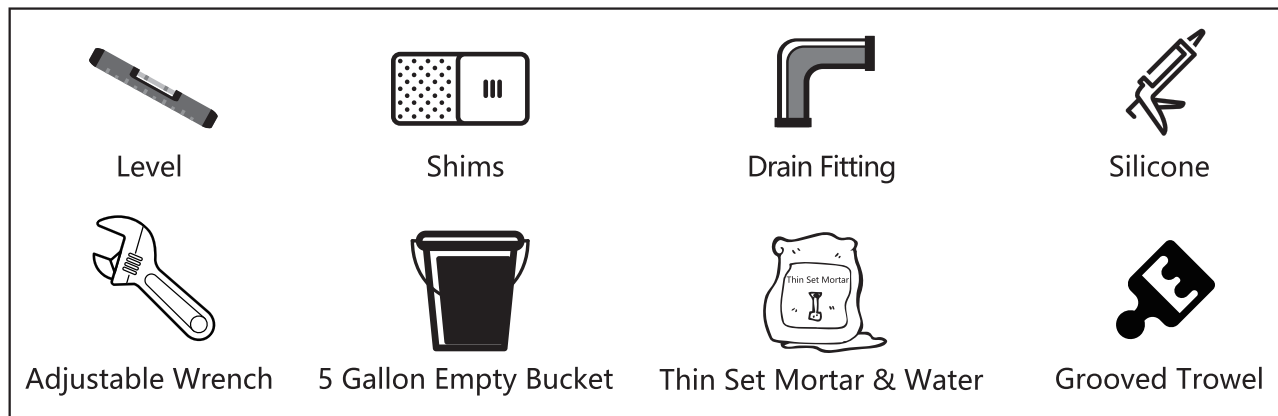

- Installation tools are not provided, please prepare by yourself.

### (2) Tips before your installtion

- The stud preparation is critical for the installation of the shower base. It is essential the stud pocket be constructed square and plumb according to the roughing in information provided.
- Please inspect the shower base for breakage and report any damage to the store of purchase. Allow the shower base to acclimate to room temperature before installing.
- Clean and scrape the floor of the shower base alcove. This space must be free of any debris in order to get a proper adhesion with the thinset mortar.
- Measure the size of the alcove to insure that the base and panels fit properly.
- Perform a trial fitting of the base within the alcove, ensuring precise alignment of the drain location with the shower base. Place a level on the base to verify that it sits perfectly level on the floor. If adjustments are required, employ shims to achieve the desired level within the alcove. Take note of the shim placements before removing the base. Tilt the base back or carefully remove it from the alcove.

## (4) INSTALLATION STEPS

● **STEP 1:**

Install the drain fitting into the shower pan.

Follow the installation instructions that came with the drain. The plumber's putty or silicone is acceptable to use with the drain.

Mix and apply thinset mortar to the floor, using the notched trowel. Spread the mixture to achieve the depth necessary to fill the voids in the floor and enable the pan to sit level. A 50 lb bag of thinset should provide at least 45-50 square feet of coverage. All supporting points should have contact with the thinset mortar.

1

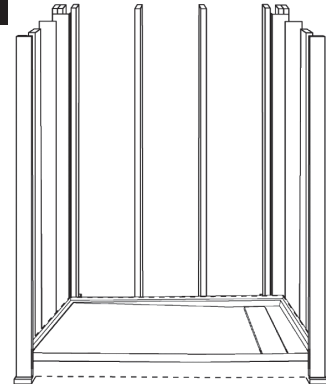

● **STEP 2:**

After applying the thinset, replace the shims (if necessary) in the proper location and set the pan into place. Make sure the pan is resting level on the thinset and shims and centered in opening.

2

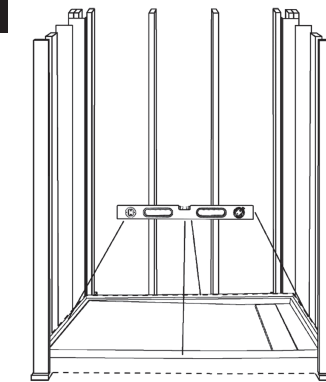

● **STEP 3:**

Clean the area at the threshold of any excess thinset. Allow the thinset and shower pan to cure for 24 hours before working in the pan area. Be sure to protect the pan floor after installation, using cardboard sheeting or a like material, until the complete project is finished.

● **STEP 4:**

Before proceeding to install the wall system, flood test the shower pan for proper drainage.

## (5) CARE AND MAINTENANCE

Simply wipe the surface with a damp towel to remove watermarks and residues. For basic stains, clean with mild detergent or general purpose cleaner. For cleaning corners and seams, spray with mildew cleaner.

**LIMITED WARRANTY COVERAGE**

**3 YEARS LIMITED WARRANTY(SHOWER BASE)  
1 YEAR LIMITED WARRANTY(DRAINER)**

The products are made with quality materials and excellent craftsmanship to provide the customers a long-lasting product. In the case of any defects in materials or craftsmanship under regular use were inspected in the third year of delivery of shower base or in the first one year of delivery of drainer, We will provide replacement parts at no charge, or at its option, replace any product or part of the product that is deemed defective, under normal installation, use, service and maintenance. This warranty applies only to the original purchaser. Proof of purchase will be required in the case of a claim. **SCRATCHES ARE NOT COVERED UNDER WARRANTY.**

The manufacturer warrants this product to be free of manufacture defects during the above mentioned warranty time. Please keep a copy of the original invoice as proof of purchase.

Optional can be provided:(1) repair or replace the defective part(s) or product(s) at no charge; (2) issue a refund of the original purchase price of the product(s) (Valid within 30 days from the date of delivery); or (3) issue a credit to be applied toward the purchase of a new The product shipping/delivery charges may apply and are in our sole discretion.

For installation, it is recommended that the installation be carried out by a licensed professional plumber. We will not be held responsible for any damage or product failure due to improper installation, misuse, or failure to use a licensed professional. And is not responsible for any removal or installation cost.

This limited warranty shall not apply to goods which have been subject to accident, negligence, improper installation, product abuse, product misuse, or use of cleaners containing abrasives, alcohol or other organic solvents, whether performed by a contractor, service company, or yourself, are excluded from this warranty.

The responsibility under this limited warranty is limited to only to replacement parts and no other costs. And will not be responsible for labor charges and/or damage incurred by installation, repair or replacement, nor for any indirect incidental or consequential damages, losses, injury or costs of any nature relating to this product Except as provided by law, this limited warranty is in lieu of and excludes all other warranties, conditions, and guarantees, whether expressed or implied, statutory or otherwise, including without restriction those merchantability of fitness for use.

**RESPONSIBILITIES OF OTHERS**

Inspecting the unit prior to installation is the responsibility of the installer or building contractor who acts on behalf of the user. They are responsible for ensuring the unit is free of defect or damage.

Notices are placed on and in the unit and on the shipping carton advising the installer of this responsibility.

In the event of a problem, the unit must not be installed. It is not responsible for failures or damage that could have been discovered, repaired, or avoided by proper inspection and testing prior to installation.

Damage occurring in transit is the responsibility of the carrier. The user or installer **MUST** open the crate and inspect the unit for damage when it is delivered. If damage is discovered, it must be reported immediately to the seller and the carrier in writing, and an inspection requested. Failure of the carrier to respond should be reported to the seller and the carrier. Your freight claims should be filed promptly thereafter.

**LIMITATIONS AND EXCLUSIONS**

This warranty does not cover instances of negligence, misuse, abuse, improper installation, carelessness, accident, hard water or mineral deposits, exposure to corrosive materials, misapplication, damages caused by improper maintenance, alteration of the product, or failure to follow care or installation instructions enclosed with your product. This warranty is void if We are subject to alteration, or if repairs are attempted by anyone other than an authorized agent of us. This warranty does not extend to plumbing or components installed by dealers, installers or by any party of company.

It will not be liable for loss of use of the inconvenience, or any other incidental or consequential costs, expense or damages. Please note that some states do not allow the exclusion or limitation of incidental damages.

**DISCLAIMER**

Except as expressly provided, there shall be no warranty or obligation, express or implied, oral or statutory. No dealer or other person has the authority to make any warranties or representations concerning Company's brand or its products. In no event shall We be held responsible for any such warranties or representations.

**WARRANTY SERVICE**

NOTE: When requesting warranty, be sure to have the following:

- Copy of original invoice
- Date of installation
- Description and pictures of defect
- Model number or description of model

To obtain warranty service and replacement part, please contact the Customer Service. We will determine whether to repair or replace your product, issue a refund, or issue a credit.