

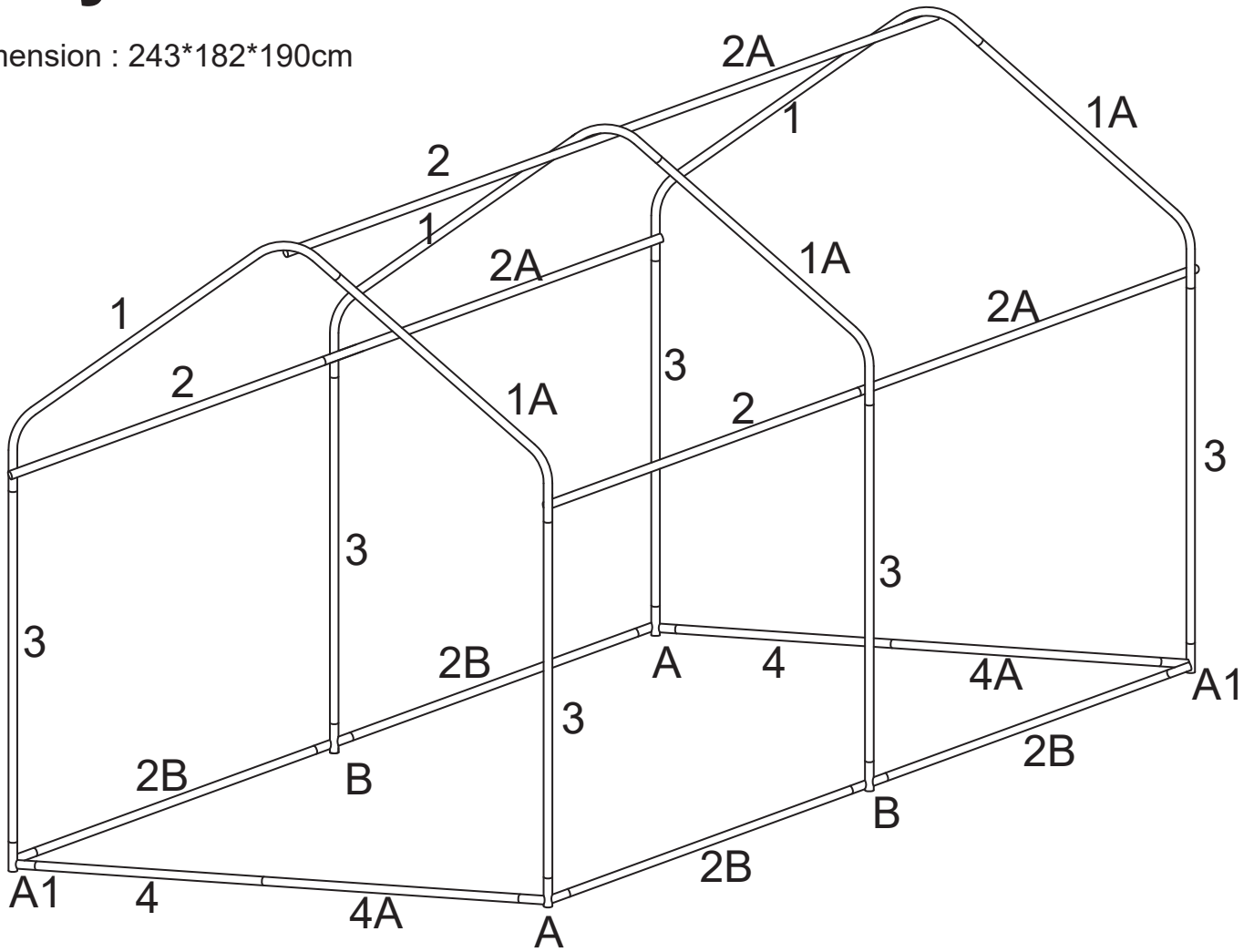









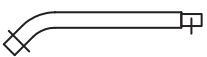
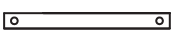
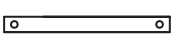

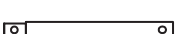
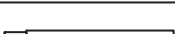

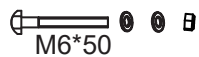

# Bicycle Shed

Dimension : 243\*182\*190cm



1#		3PCS
1A#		3PCS
2#		3PCS
2A#		3PCS
2B#		4PCS
3#		6PCS
4#		2PCS
4A#		2PCS
A#	 90°	2PCS
A1#	 90°	2PCS

B#		2PCS
	 M6*30	2PCS
	 M6*50	9PCS
		16PCS
		4PCS
		4PCS
		1PC
		1PC
		1PC

If you have any questions, please contact us : [info@sumolulife.com](mailto:info@sumolulife.com)

M6\*30mm 2pcs

1

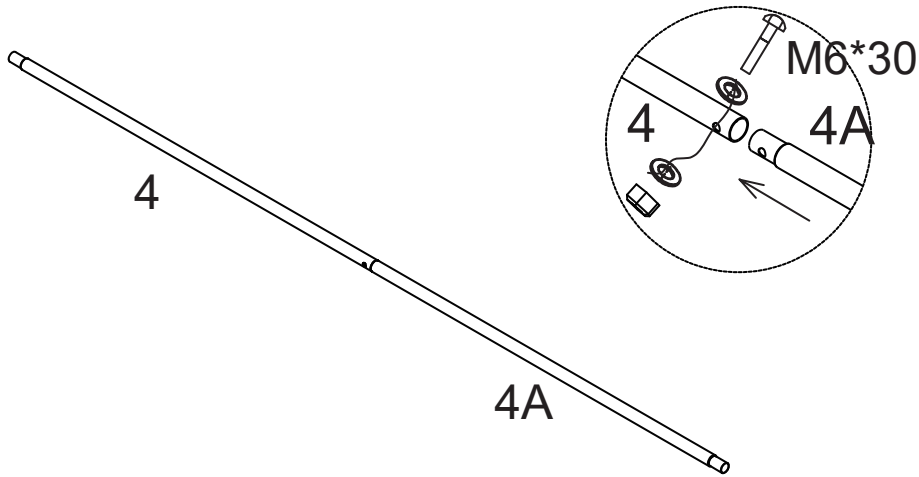

2

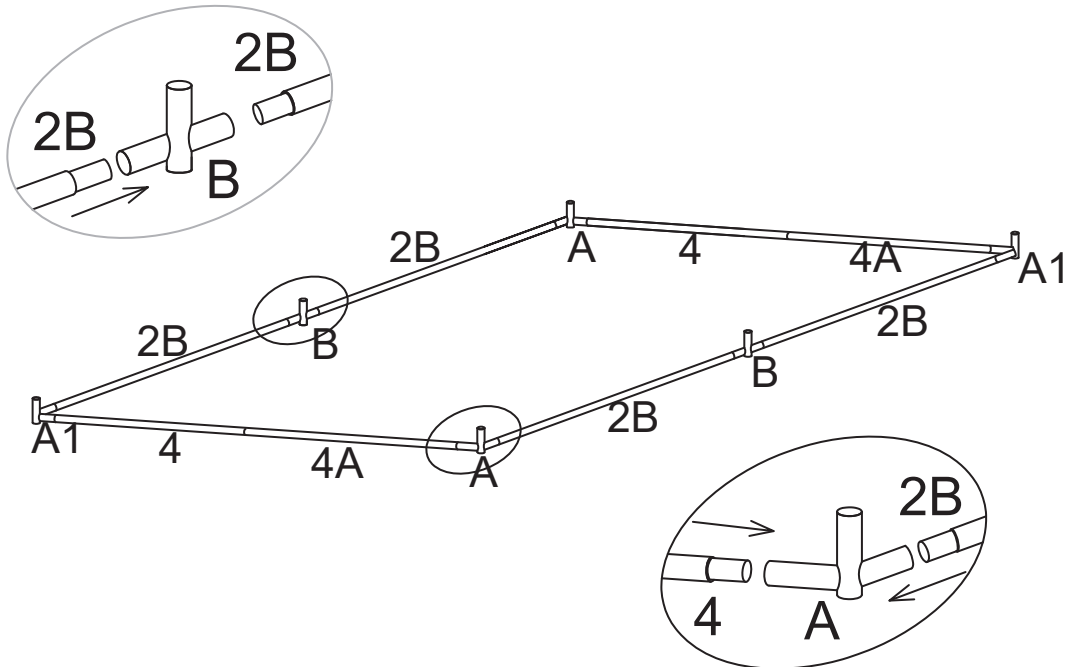

3

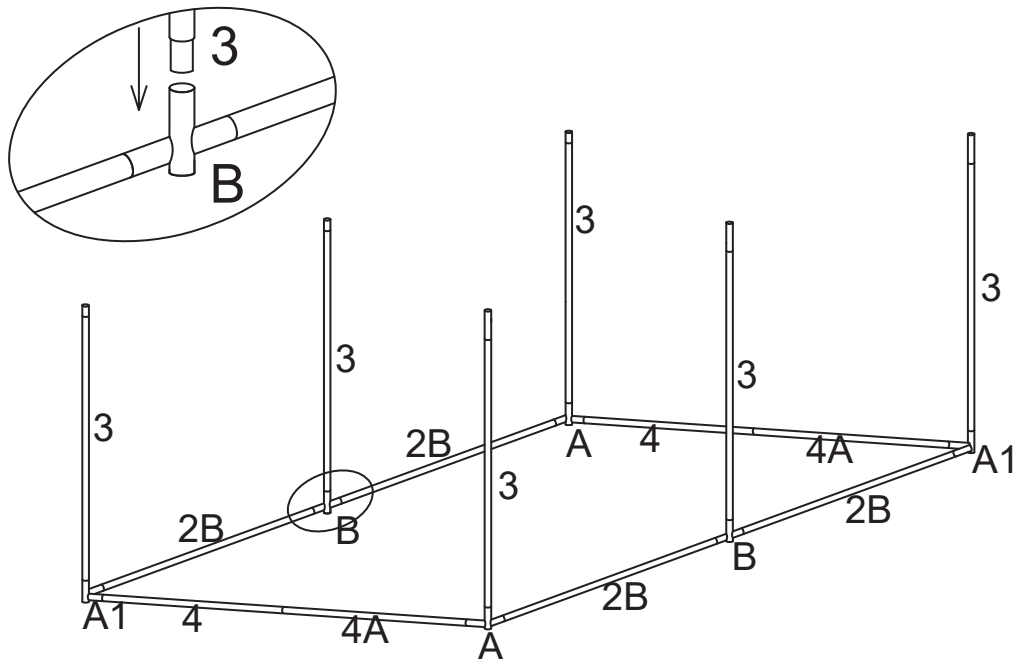

M6\*50mm 3pcs

4

Note : Make sure the nut is installed in the right direction

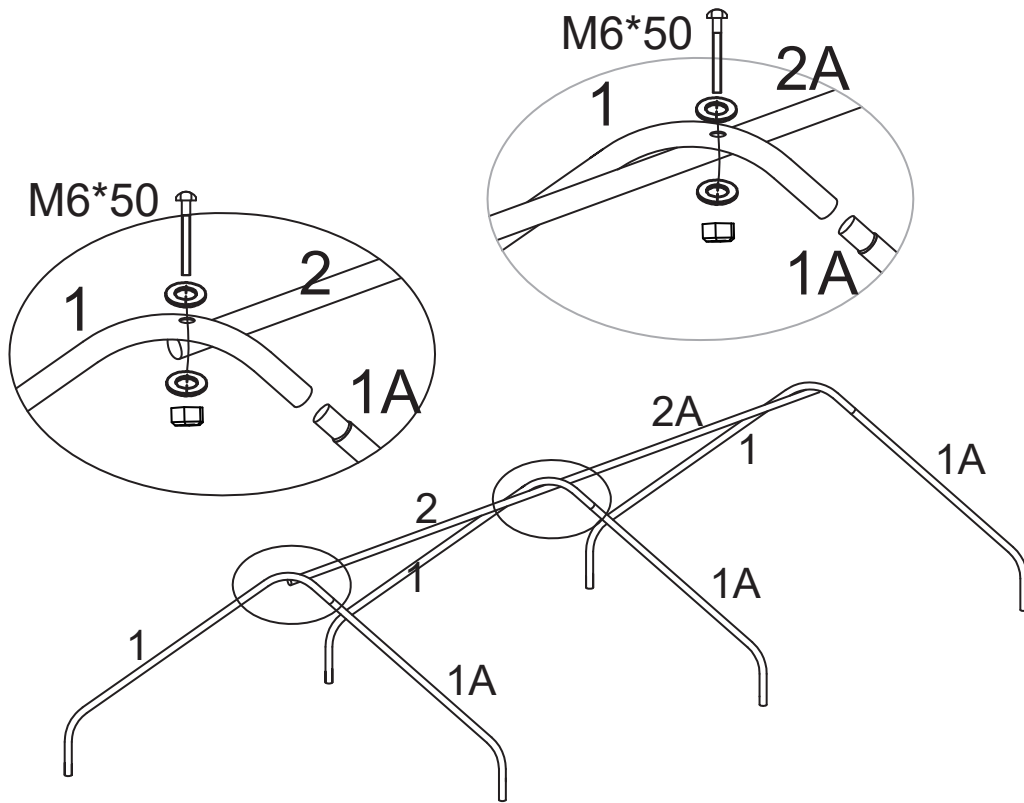

M6\*50mm 6pcs

5

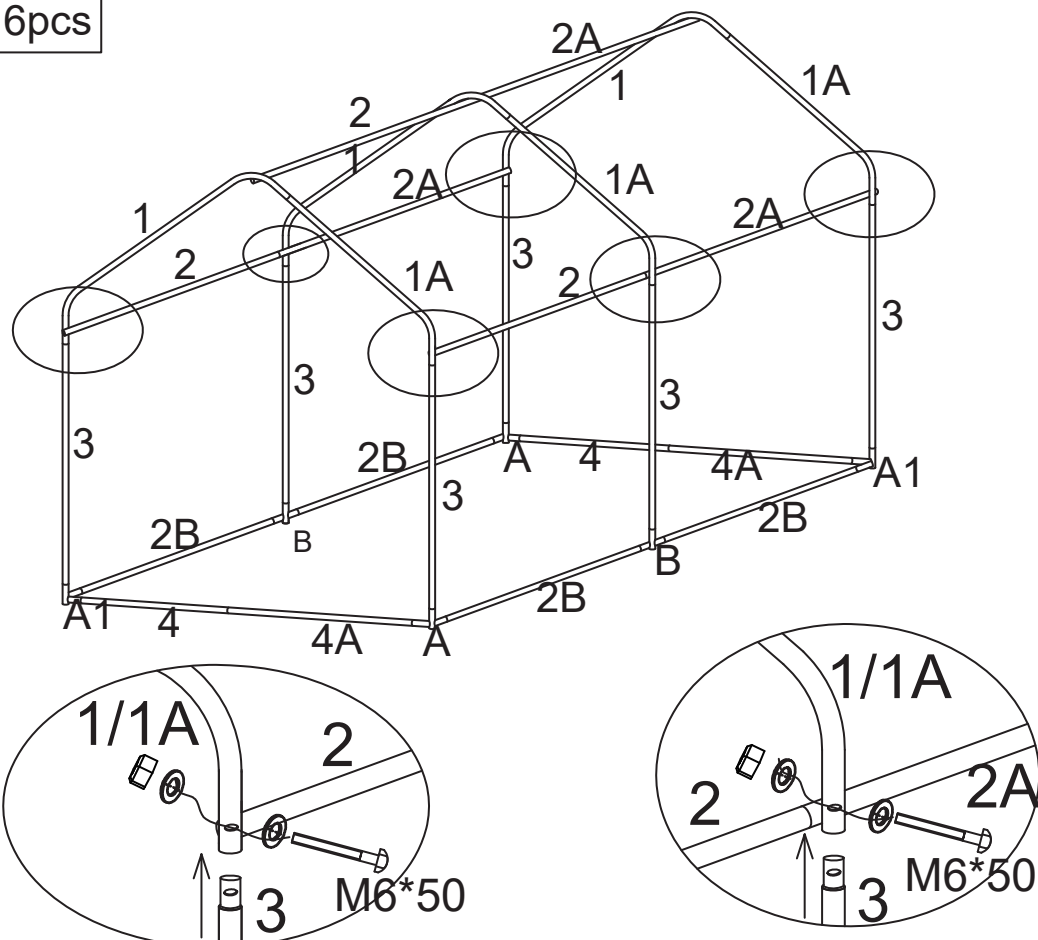

Note : Make sure the nut is installed in the right direction

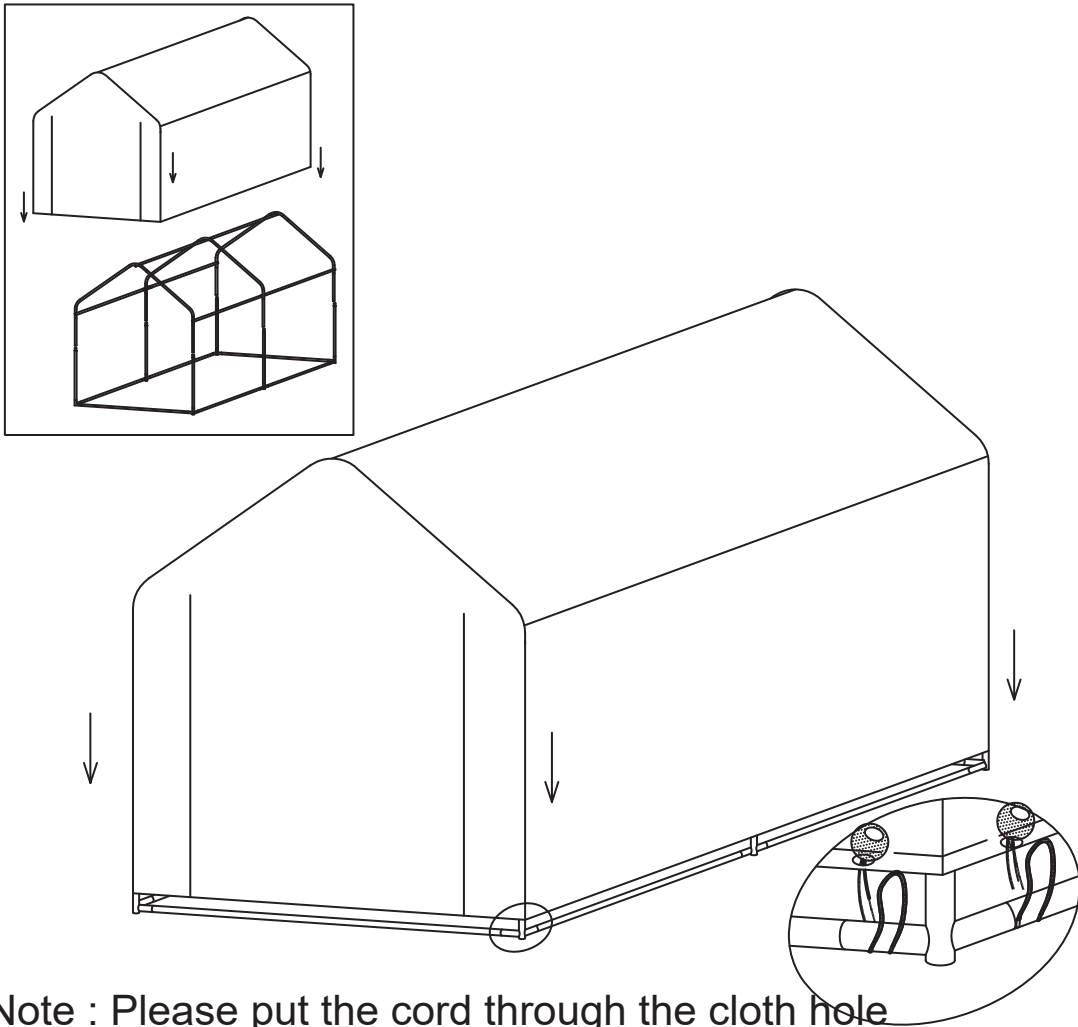

Note : Please put the cord through the cloth hole

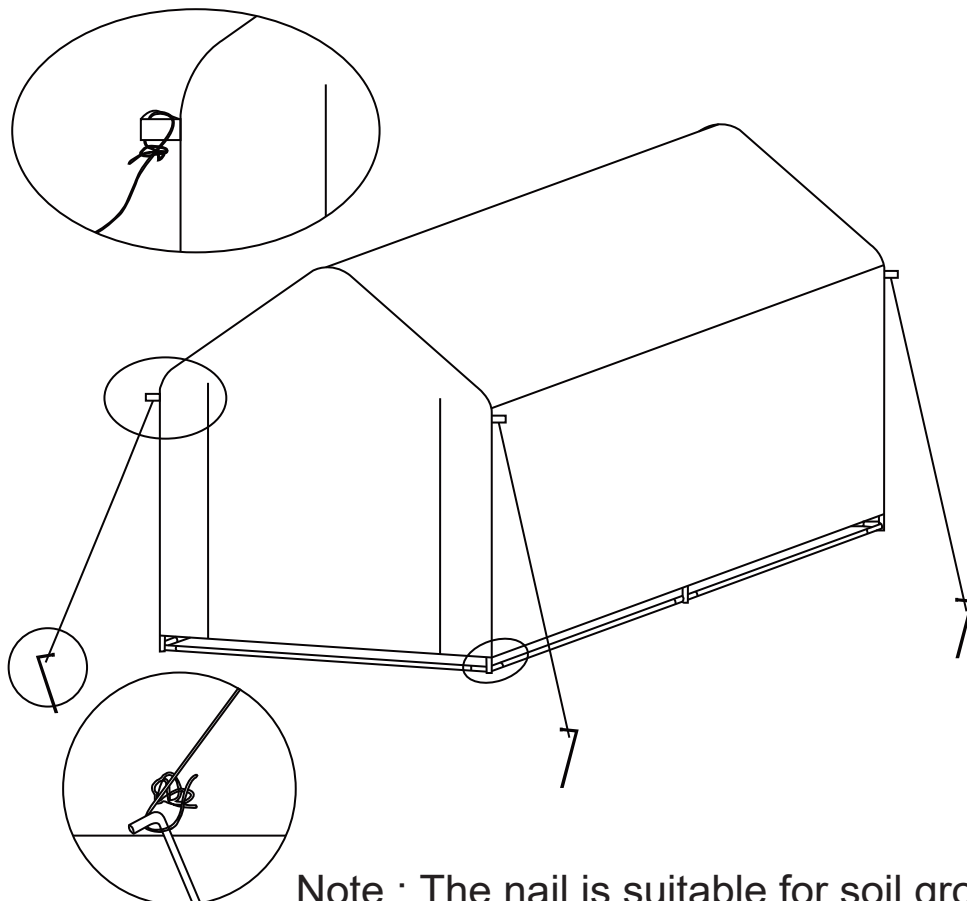

Note : The nail is suitable for soil ground.  
Need to pay attention when using in concrete floor!