

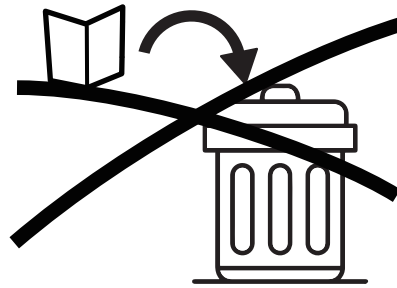

# **ASSEMBLY INSTRUCTIONS**

# NOTICE

IMPORTANT, RETAIN FOR FUTURE REFERENCE: READ CAREFULLY  
WICHTIG, FÜR SPÄTERE NACHSCHLAGE AUFBEWAHREN: SORGFÄLTIG LESEN  
IMPORTANTE, GUARDAR PARA REFERENCIA POSTERIOR: LEER ATENTAMENTE  
IMPORTANTE, CONSERVARE PER RIFERIMENTI FUTURI: LEGGERE ATTENTAMENTE  
IMPORTANT, À CONSERVER POUR RÉFÉRENCE FUTURE : LIRE ATTENTIVEMENT

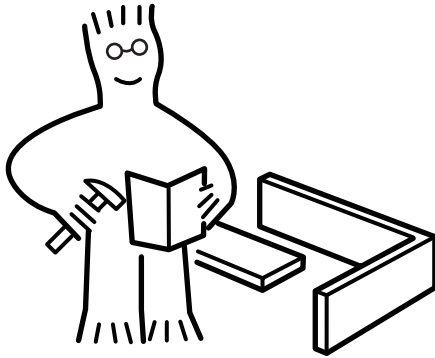

Assemble on a flat, clean and soft surface.  
Auf einer flachen, sauberen und weichen Oberfläche zusammenbauen.  
Assembler sur une surface plate, propre et douce.  
Assemblare su una superficie piatta, pulita e morbida.  
Ensamblar sobre una superficie plana, limpia y suave.

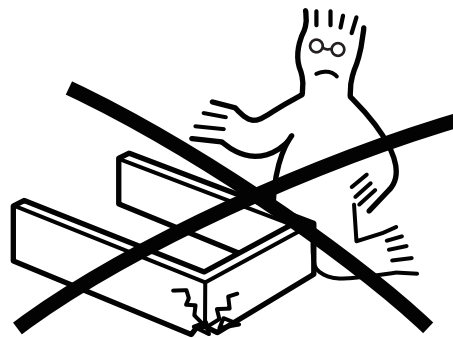
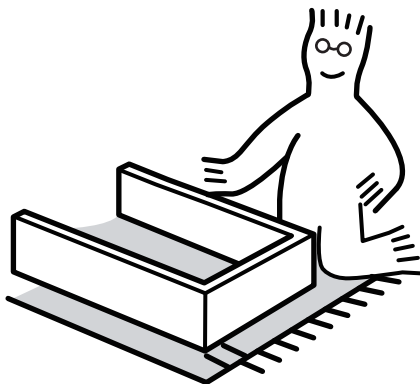

Professional installation is highly recommended.  
Eine professionelle Installation wird dringend empfohlen.  
Une installation professionnelle est fortement recommandée.  
Si raccomanda vivamente l'installazione professionale.  
Se recomienda altamente la instalación profesional.



Periodically Check That All Components Are Tightly Secured.  
Überprüfen Sie Regelmäßig, Dass Alle Komponenten Fest Gesichert Sind.  
Vérifiez Périodiquement Que Tous Les Composants Sont Bien Fixés.  
Controllare Periodicamente Che Tutti I Componenti Siano Ben Fissati.  
Verifique Periódicamente Que Todos Los Componentes Estén Bien Asegurados.



---

## **SOLAR LIGHT**

### **How These Solar Lights Work**

During the day, the solar panel converts sunlight into electricity and recharges the battery. At night, the lights turn on automatically using the electricity stored during the day. The number of lighting hours depends on geographical location, weather condition and exposure time under sunlight. Under normal conditions, if the light is charged in full sunlight for about 8 hours every day, the light should last for at least 6 hours at night.

### **Choosing a Location**

Choose an outdoor location in full direct sunlight where the solar panel can receive at least 6 hours of light each day. Shadowed locations will not allow the batteries to charge fully and will reduce the hours of night-time lighting. The selected location should not be near other night-time light sources such as porch light or streetlight, as they may cause the solar light to turn off automatically.

### **First-time Use**

The solar lights should be charged in full sunlight for 24 hours with the switch in the "ON" position. This allows the rechargeable battery to reach its maximum capacity.



### **Using Solar Lights**

1. Press the power switch from "OFF" into the "ON" position so that the battery can be charged. (The "OFF" position means the solar lights are completely turned off and can't be charged.)
2. Then choose a suitable location, and the light will automatically turn on at dusk and off at dawn.

### **WARNING**

Do not dispose of the batteries in the regular trash, municipal waste streams or by fire, as the batteries may leak or explode. Do not open, short-circuit or mutilate the batteries, as this could result in injury. Preserve our environment by recycling the batteries or disposing of them in accordance with local, state or federal regulations.

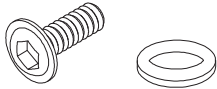
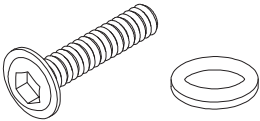
# PARTS

Item no. Nr. N° d'article Articolo No. Artículo No.	Reference Image Referenzbild Image de référence Immagine di riferimento Imagen de referencia	Qty. Menge Qté. Qtà Cant.	Item no. Nr. N° d'article Articolo No. Artículo No.	Reference Image Referenzbild Image de référence Immagine di riferimento Imagen de referencia	Qty. Menge Qté. Qtà Cant.
<p style="text-align: center;">A</p>	<div style="text-align: center;">  <p>M6 X 16MM</p> </div>	<p>X48</p>			
<p style="text-align: center;">B</p>	<div style="text-align: center;">  <p>M6 X 35MM</p> </div>	<p>X8</p>			
<p style="text-align: center;">-</p>	<div style="text-align: center;">  </div>	<p>X1</p>			

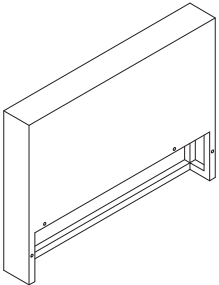
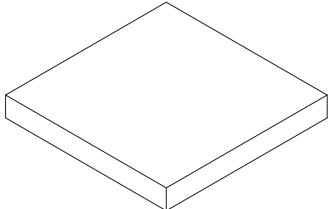
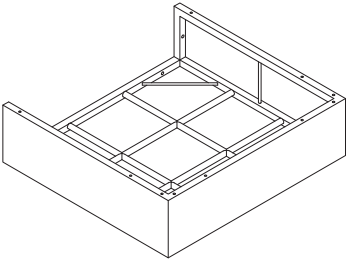
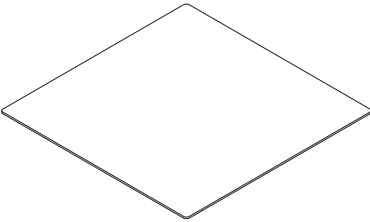
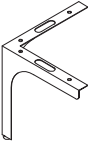
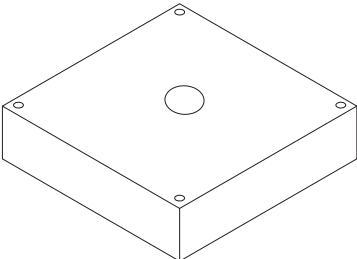
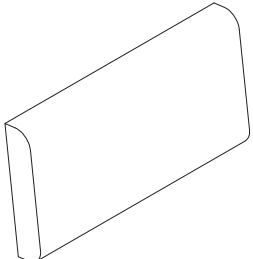
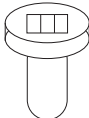
Item no. Nr. N° d'article Articolo No. Artículo No.	Reference Image Referenzbild Image de référence Immagine di riferimento Imagen de referencia	Qty. Menge Qté. Qtà Cant.	Item no. Nr. N° d'article Articolo No. Artículo No.	Reference Image Referenzbild Image de référence Immagine di riferimento Imagen de referencia	Qty. Menge Qté. Qtà Cant.
1		X2	5		X2
2		X2	6		X1
3		X12	7		X1
4		X2	8		X1

# EXPLODED VIEW

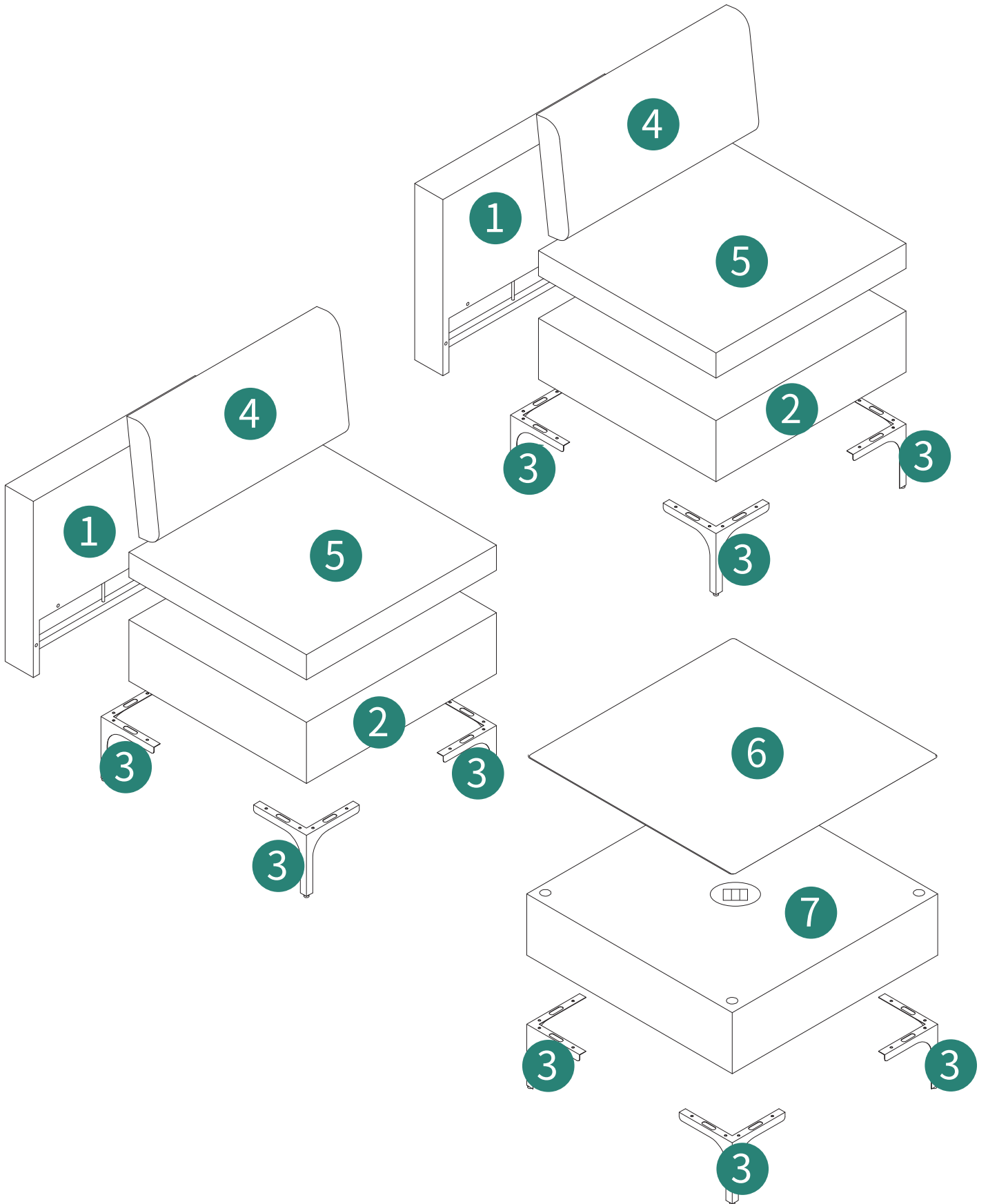

# ASSEMBLY

1

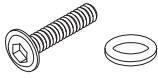

(B)x8

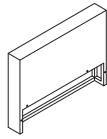

①x2

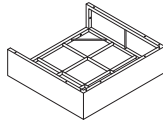

②x2

Repeat step1 twice

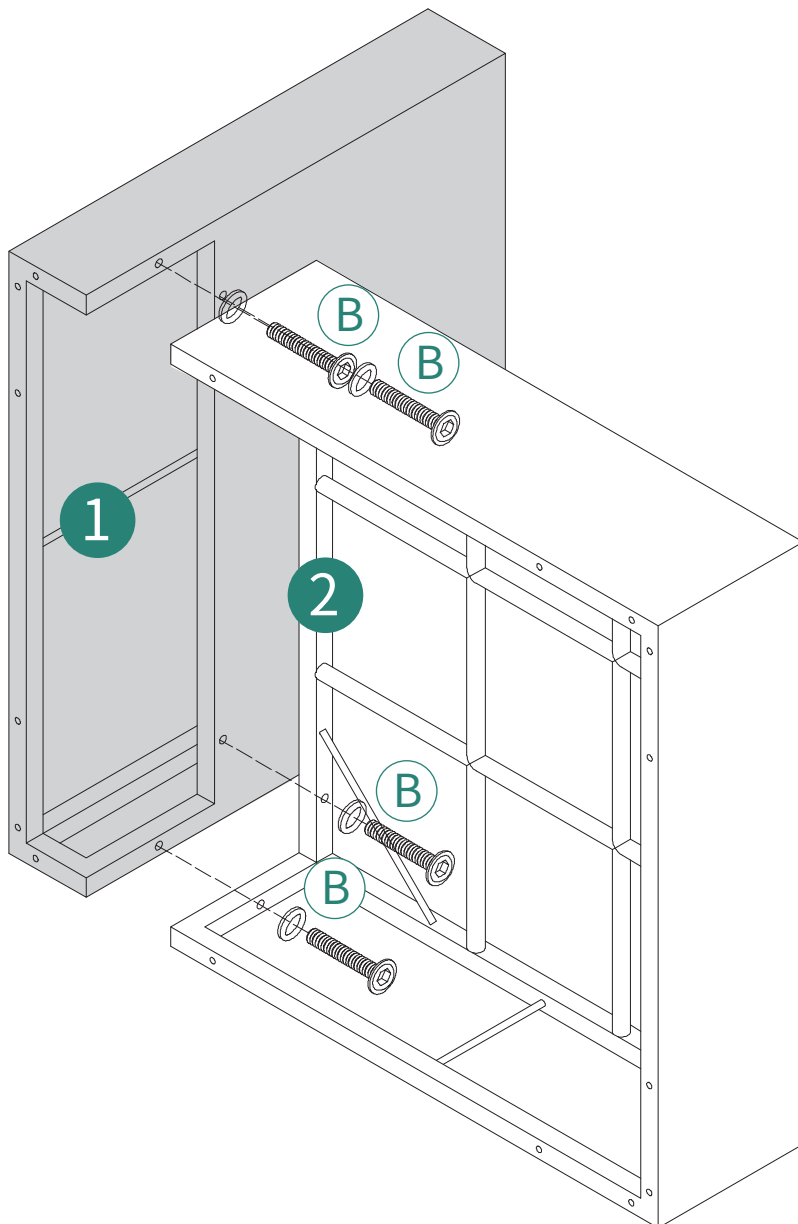
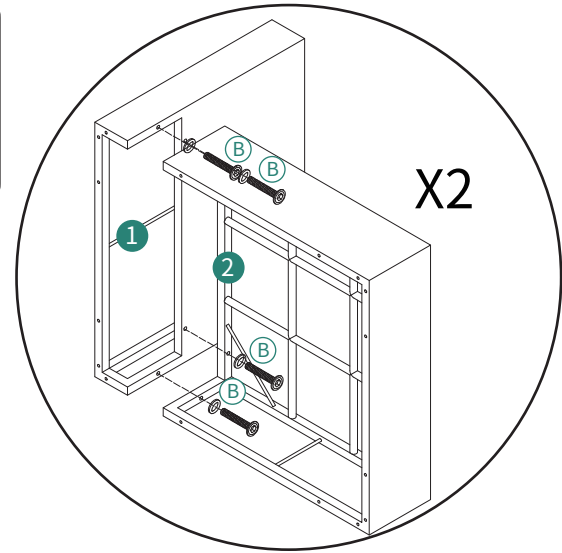

2

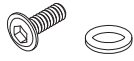

A x 32

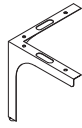

3 x 8

Repeat step 2 twice

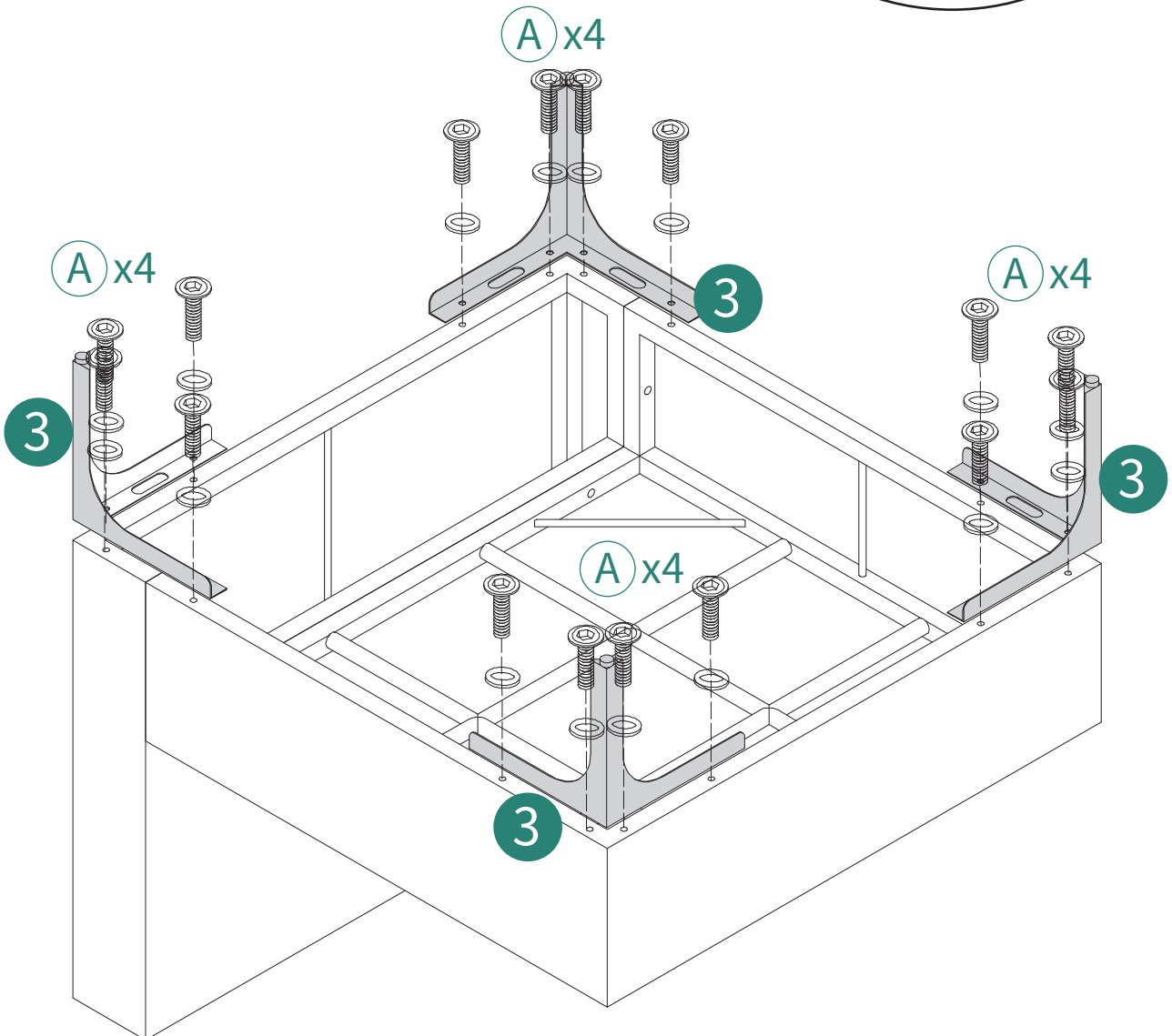
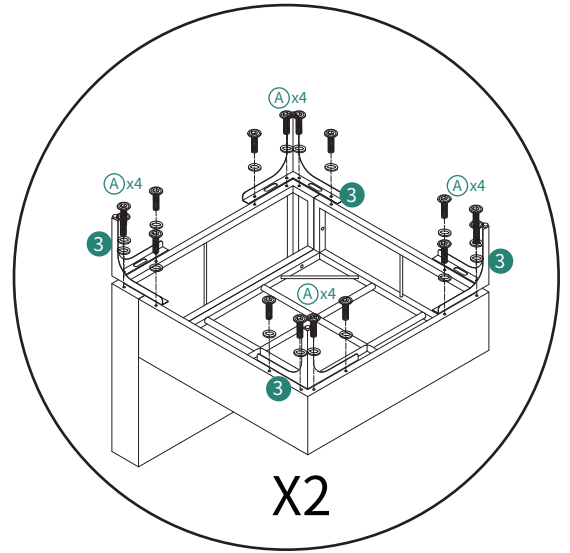

3

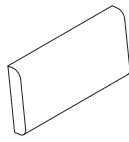

④x2

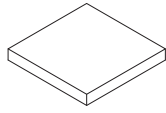

⑤x2

Repeat step 3 twice

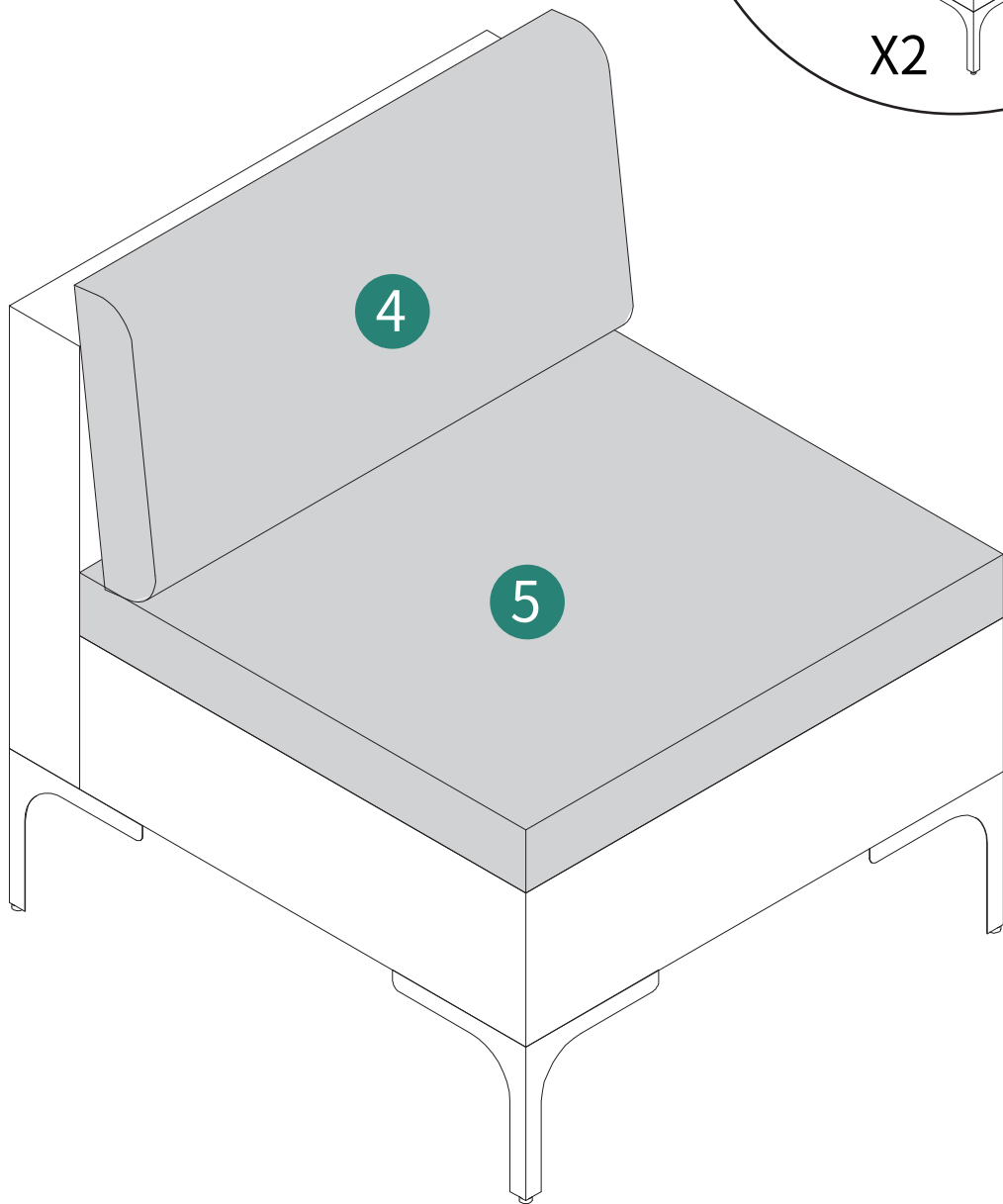
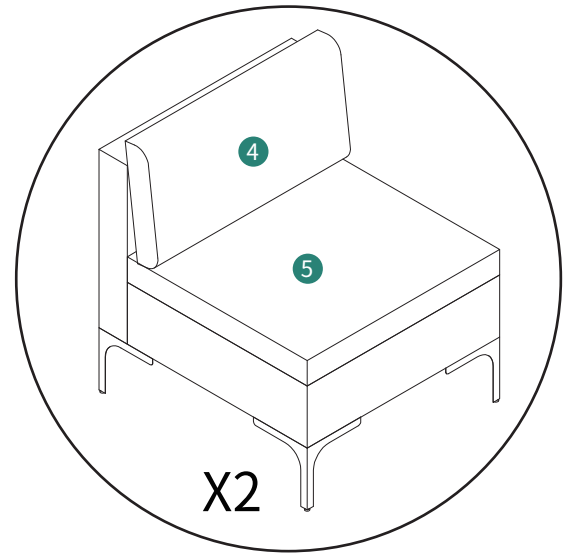

4



(A)x16

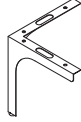

(3)x4

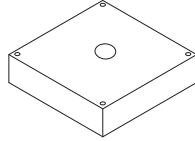

(7)x1

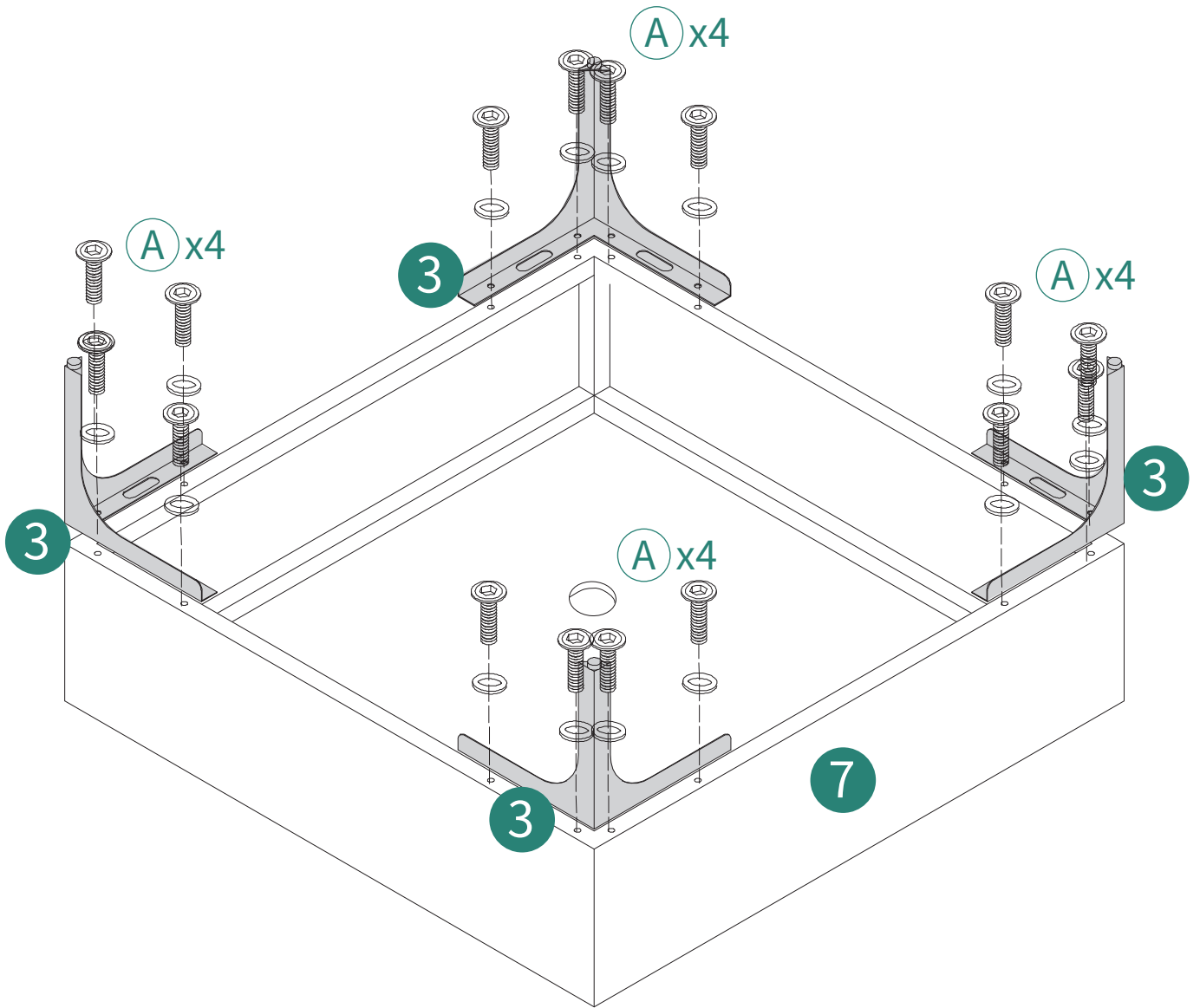

5

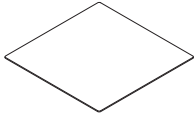

⑥x1



⑧x1

The solar lights should be charged in full sunlight for 24 hours with the switch in the "ON" position, and then put it in the coffee table.

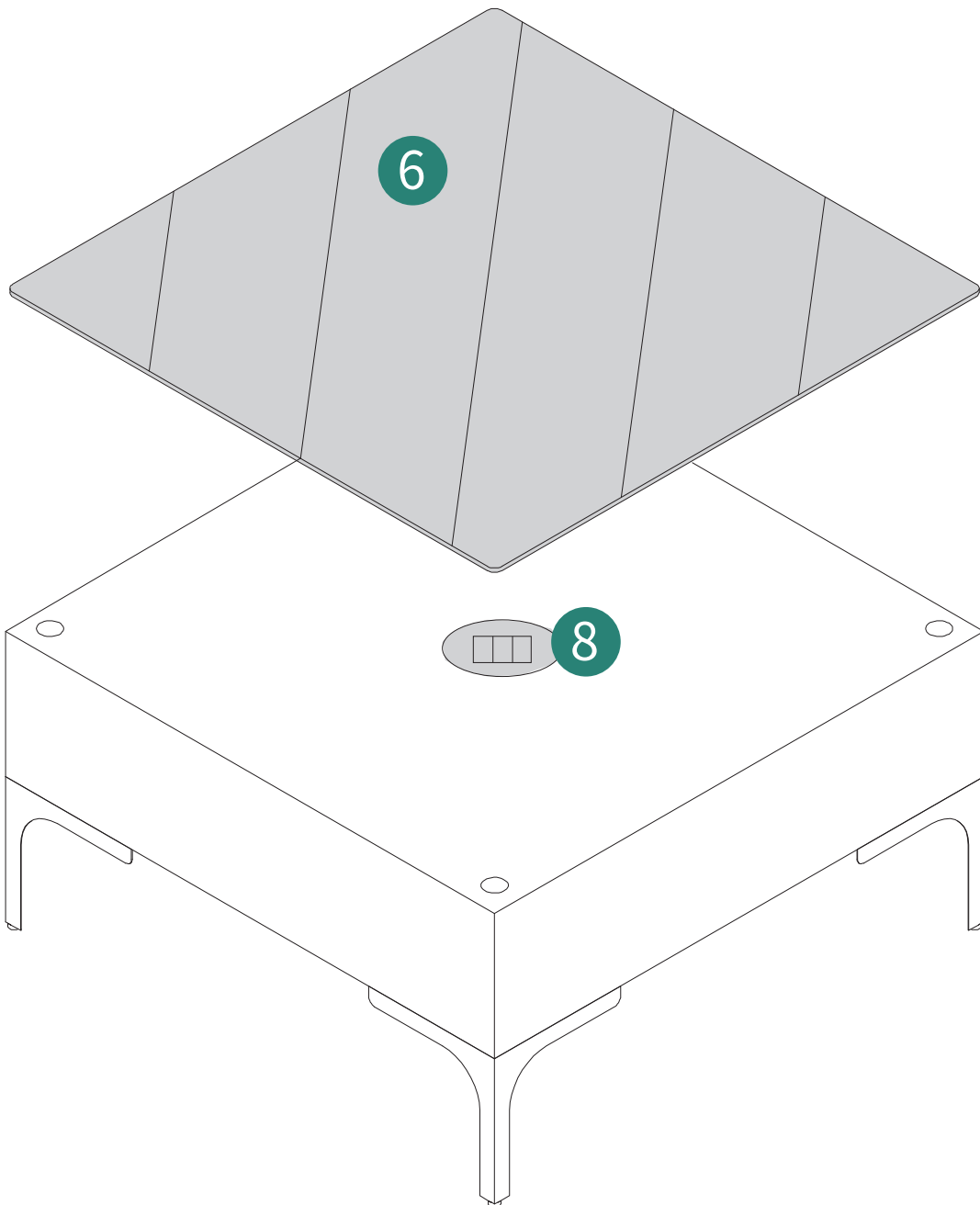

6

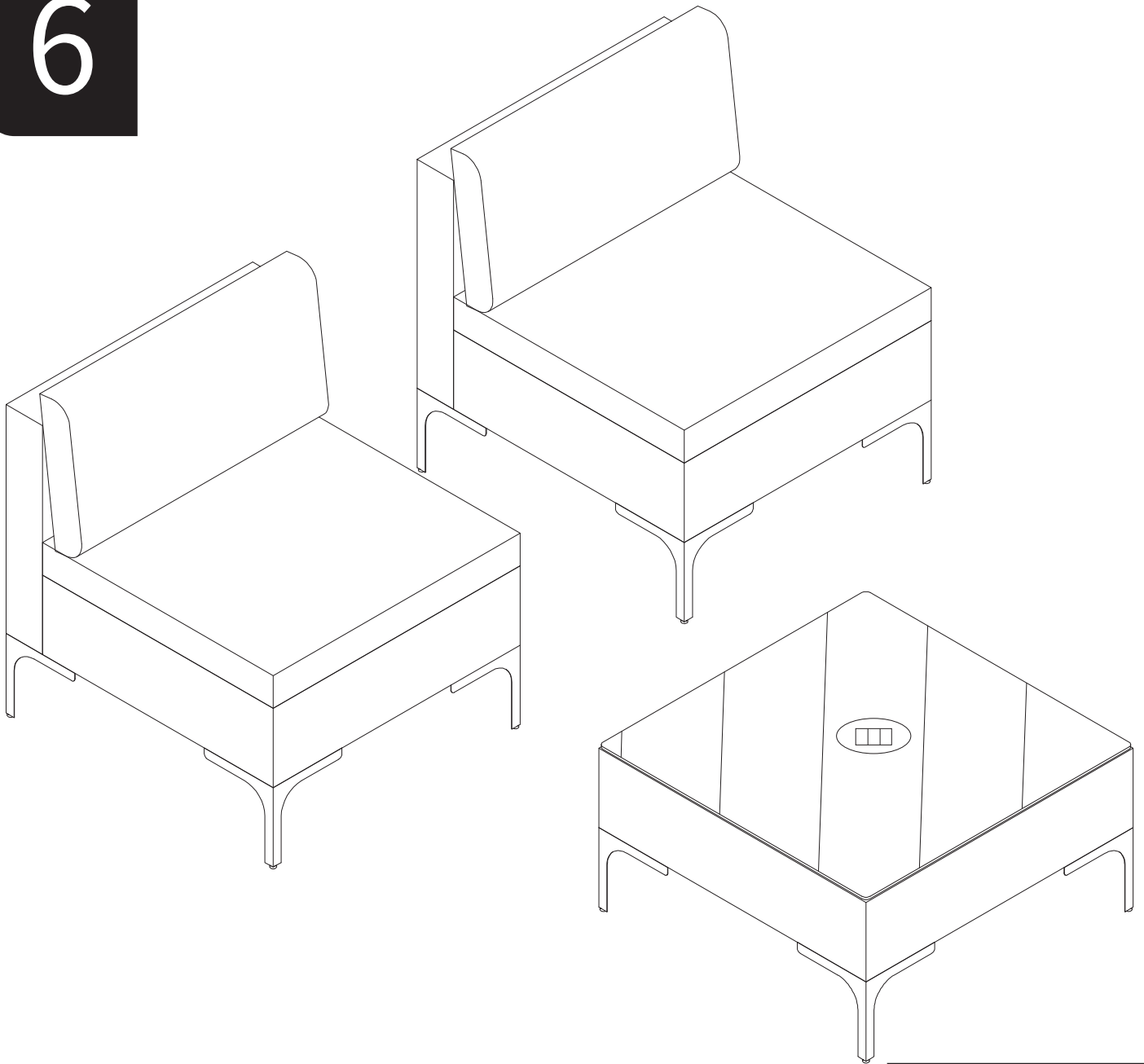

Installation Completed

Installation Abgeschlossen

Installation Complétée

Installazione Completata

Instalación Completada

# HELP CENTER



Inquiry



Assembly issue



Missing parts

If you encounter any difficulties during assembly, please contact us.  
Wenn Sie während der Montage auf Schwierigkeiten stoßen, kontaktieren Sie uns bitte.  
Si vous rencontrez des difficultés lors du montage, veuillez nous contacter.  
Se incontri difficoltà durante il montaggio, ti preghiamo di contattarci.  
Si encuentras alguna dificultad durante el ensamblaje, por favor contáctanos.

# DISCLAIMER

Manufacturer and seller expressly disclaim any and all liability for personal injury, property damage or loss, whether direct, indirect, or incidental, resulting from the incorrect attachment, improper use, inadequate maintenance, unapproved modification, or neglect of this product.

Der Hersteller und Verkäufer lehnen ausdrücklich jegliche Haftung für Personenschäden, Sachschäden oder Verluste ab, egal ob direkt, indirekt oder zufällig, die durch falsche Anbringung, unsachgemäßen Gebrauch, unzureichende Wartung, nicht genehmigte Änderungen oder Vernachlässigung dieses Produkts entstehen.

El fabricante y vendedor renuncian expresamente a toda responsabilidad por lesiones personales, daños materiales o pérdidas, ya sean directos, indirectos o incidentales, derivados de la incorrecta colocación, uso inadecuado, mantenimiento insuficiente, modificación no aprobada o negligencia de este producto.

Il produttore e il venditore declinano espressamente ogni responsabilità per lesioni personali, danni materiali o perdite, dirette, indirette o incidentali, derivanti dall'errato fissaggio, uso improprio, manutenzione inadeguata, modifica non autorizzata o negligenza di questo prodotto.

Le fabricant et le vendeur déclinent expressément toute responsabilité en cas de blessures corporelles, de dommages matériels ou de pertes, qu'ils soient directs, indirects ou accessoires, résultant de la fixation incorrecte, de l'utilisation inappropriée, de l'entretien insuffisant, de la modification non approuvée ou de la négligence de ce produit.