

Assembly Instructions

Caution: You must read this before you proceed

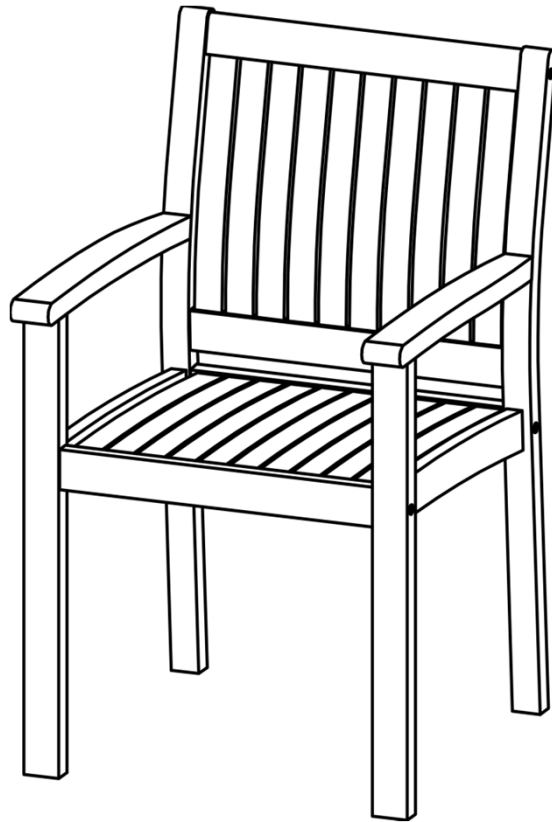

Chair

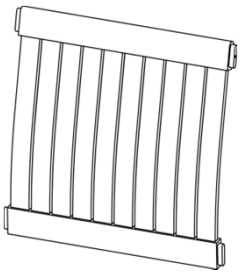
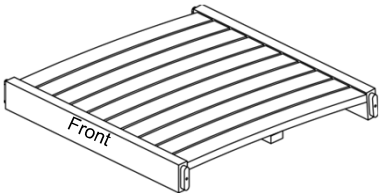
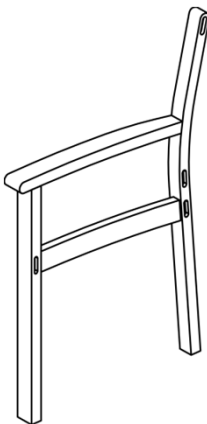
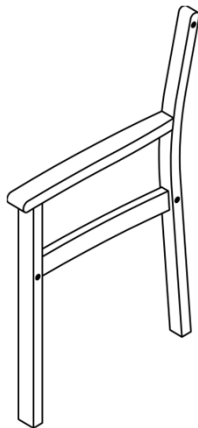

Parts List

Label	Picture	Description	QTY
A	 A line drawing of a rectangular backrest panel with vertical slats and a curved top edge.	Backrest Panel	1
B	 A line drawing of a rectangular seat panel with horizontal slats. The word "Front" is written on the left side.	Seat Panel	1
C	 A line drawing of a chair leg panel showing the front and side legs connected by a horizontal crossbar.	First Leg Panel	1
D	 A line drawing of a chair leg panel showing the back and side legs connected by a horizontal crossbar.	Second Leg Panel	1

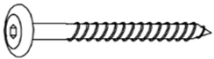
Hardware

Label	Picture	Description	QTY
①	 A line drawing of a screw with a hexagonal head and a threaded shaft.	Screw (M6x80mm)	7
②	 A line drawing of an L-shaped Allen key.	Allen Key	1

Assembly Preparation

Before Beginning Assembly:

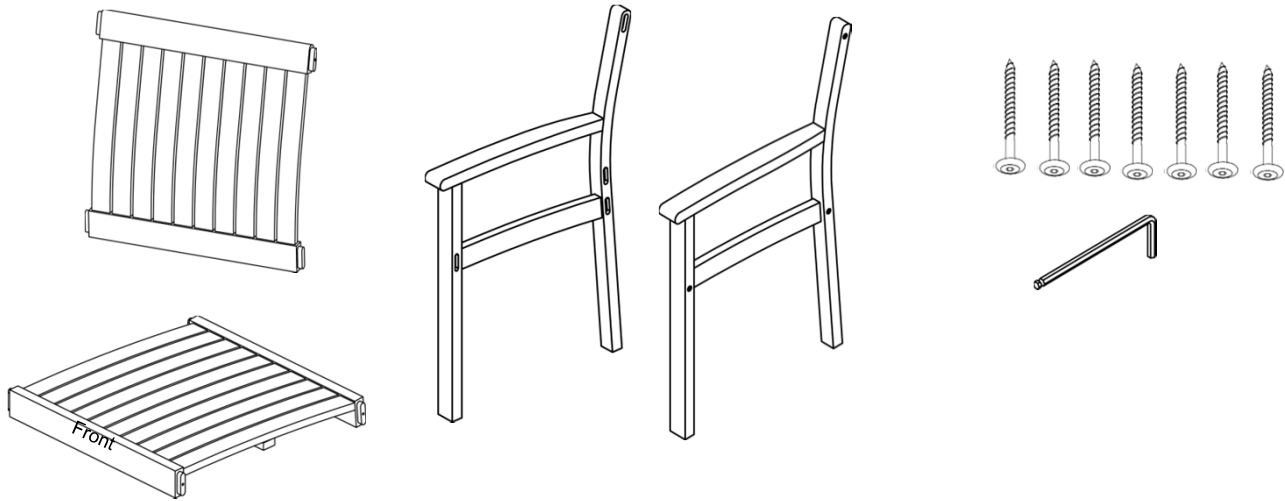

- Read instructions, cover to cover-



- Have 2 adults on hand for assembly-



- Do not assemble on flooring or carpet-



- Assemble on a clean non-marring surface (packing foam)-



- Save all packaging until finished-

Assembly Steps

Overview

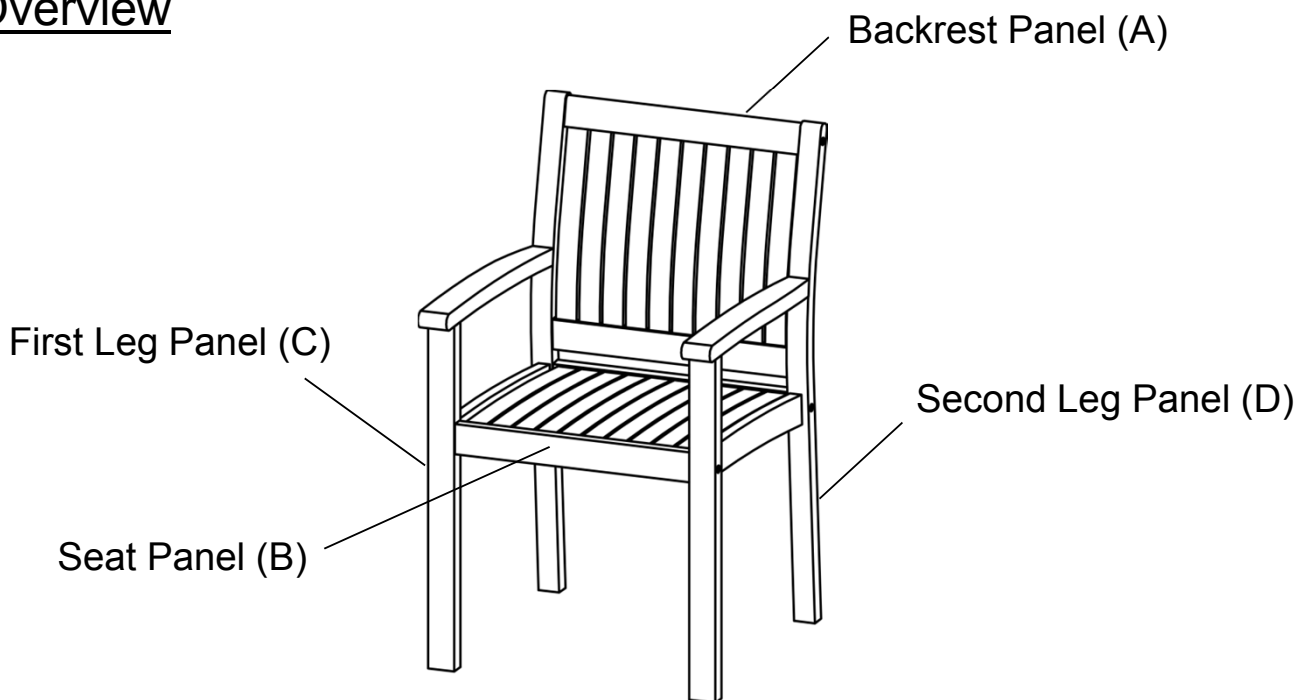

This Chair has multiple parts and may require up to 30 minutes to assemble. To give you an overview of the Chair parts, the above picture is to help you put the various parts into perspective. Please read through the instructions below to familiarise yourself with the parts and steps before assembly.

Step 1

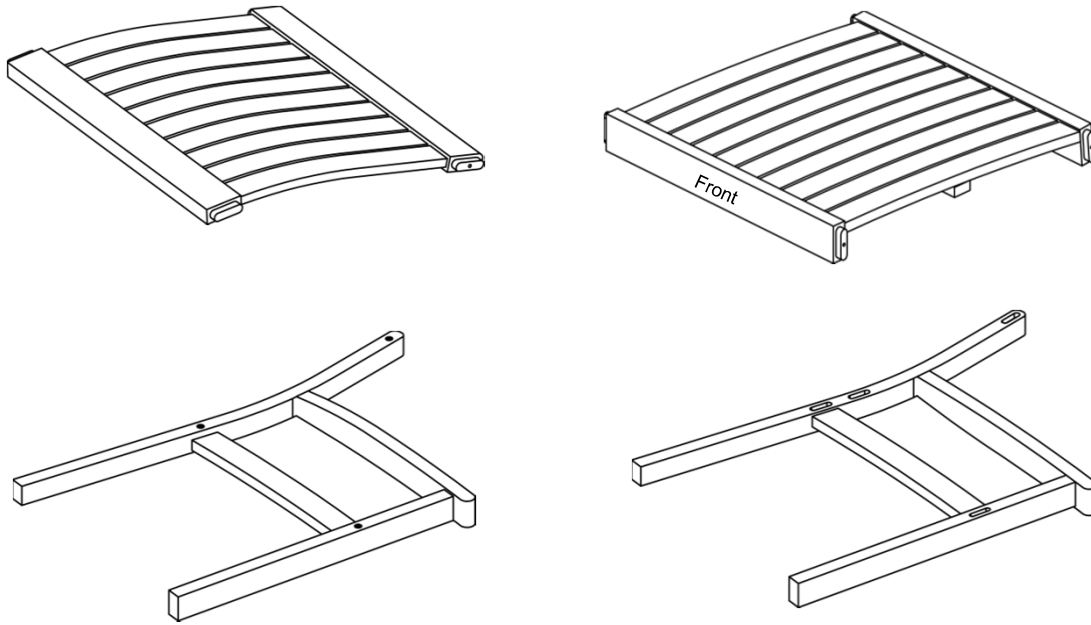

Unpack and place all parts on a clean, non-marring surface.

Step 2

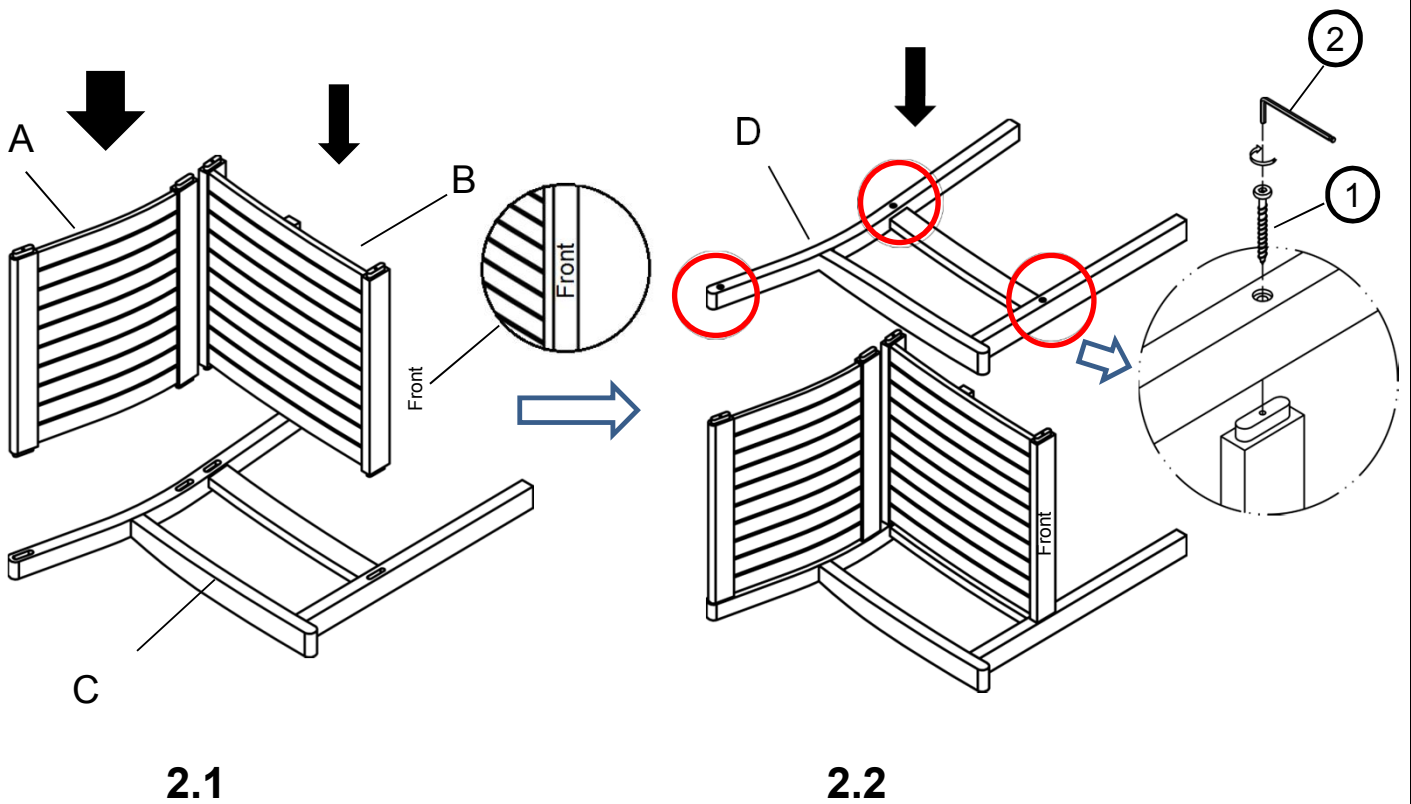

2.1) Position First Leg Panel(C) and Backrest Panel(A) to Seat Panel(B).

2.2) Attach Second Leg Panel(D) to Backrest Panel(A), and Seat Panel(B) using Screws(①) with Allen Key(②).

Do not fully tighten the Screws.

Note: Be sure to position the Seat Panel correctly as indicated by the label "Front"

Step 3

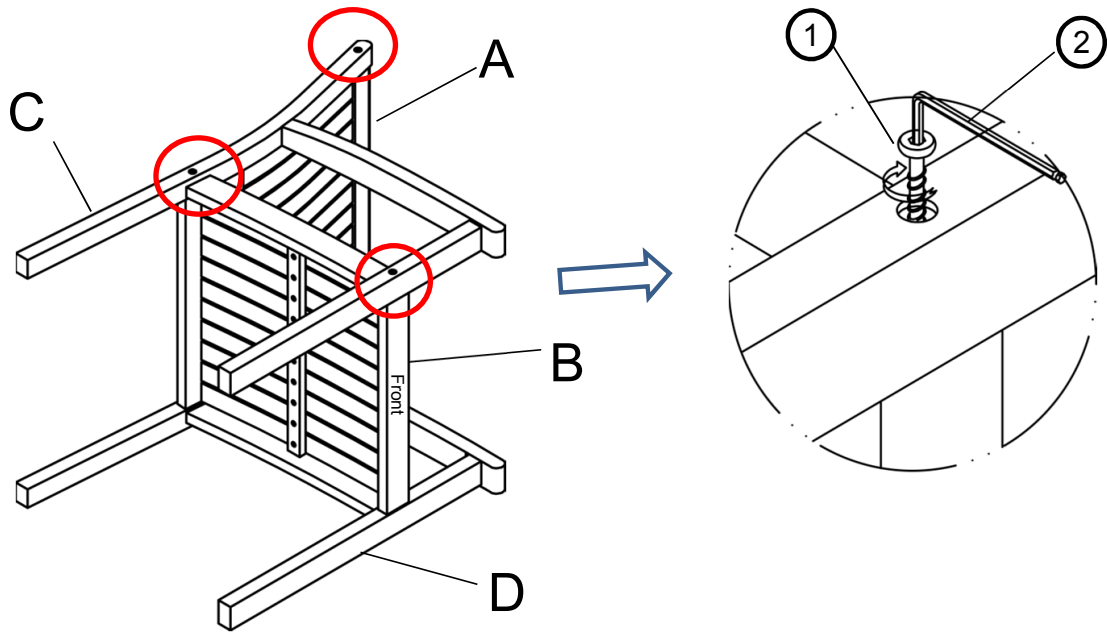

With assistance from an adult partner, turn the Chair Frame over onto the other side.
Attach First Leg Panel(C) to Backrest Panel(A), and Seat Panel(B) using Screws(①) with Allen Key(②).

Do not fully tighten the Screws.

Step 4

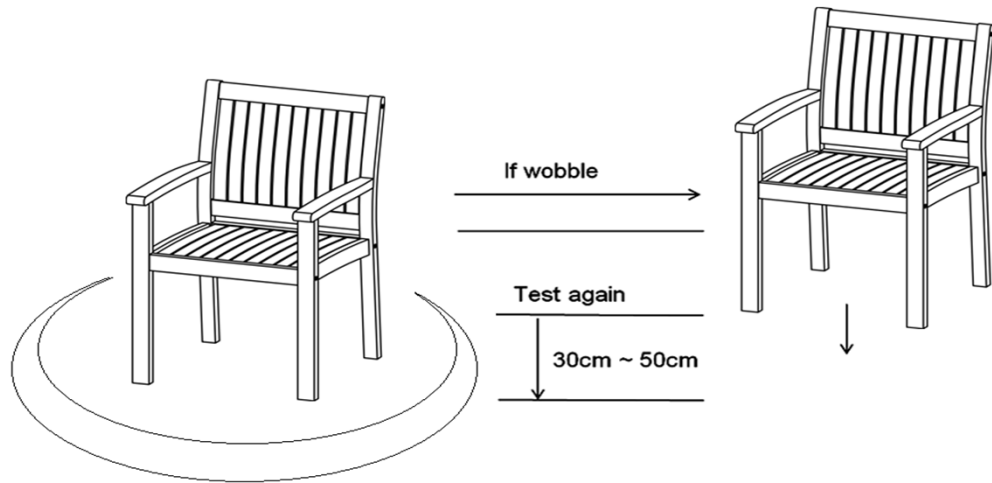

Place the Chair on a LEVEL SURFACE to see if it wobbles.

If it wobbles, lift the Chair to some 30cm to 50cm high from the ground. Keep your feet and toes well away from the drop zone.

Drop the Chair freely and vertically with the four legs, hitting the ground, at the same time.

This Drop Test will help to ensure that all the Screws and gaps reach full alignment status.

Test again for evenness on a LEVEL SURFACE.

If no wobbles are found, proceed to tighten all the Screws.

When tightening the Screws, tighten sequentially.

DO NOT tighten any Screw fully and then move on towards the next one.

This could cause the frame to warp.

If there are still wobbles, loosen the Screws and execute this same drop test.



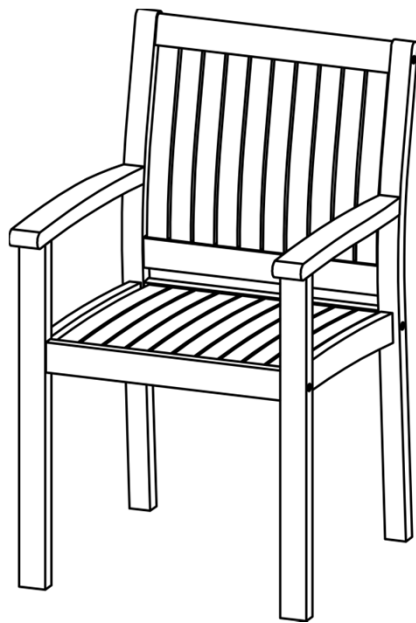





Step 5



Your Chair is ready to use.

This Chair can only be used on a flat, level surface

Care & Maintenance

- ⊘  ● Do not put hot items directly on furniture surface
 - ⊘  ● Do not clean furniture with harsh cleansers or polish.
 - ✓  ● To obtain the longest lifespan of your outdoor products, minimizing exposure to direct sunlight is recommended.
 - ⊘  ● Children should not climb or jump on the furniture.
 - ⊘  ● Do not write on furniture without a padded barrier to protect the surface.
 - ✓  ● To obtain the longest lifespan of your outdoor products, avoid extended and lengthy exposure to rain, snow, and direct sunshine. Whenever possible cover the product and /or place under patio or awnings.
 - ⊘  ● Not for commercial use. For residential use only .
 - ⊘  ● Stains may be removed with mild soap solution and damp cloth.
-
- ✓  ● Dust and pick-up spills using a clean, non-colored, lint-free cloth .