

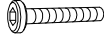

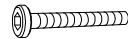







a	 Bolt	M6*35	8	b	 Bolt	M6*50	15
c	 Bolt	M6*60	4	d	 Bolt	M6*85	2
e	 Bolt	M6*15	2	f	 Washer	M6	46
g		M6 Screw Nut	15	h		Steel Piece	1
i	 Bolt	M6*30	4	j		Floor Mat	4
k		Floor Mat	2	l		Open Spanner	1
m		Hex Wrench	1				

		
A Right armrest ×1	B Left armrest ×1	C Seat ×2
		
D Right Front Panel ×2	F Right Back ×1	G Left Back ×1
		
H Seat Cushion ×3	I Back Cushion ×3	

1

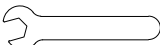

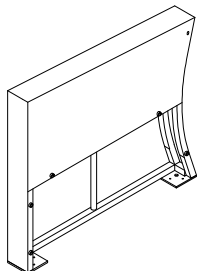
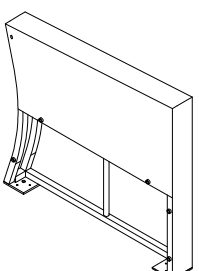
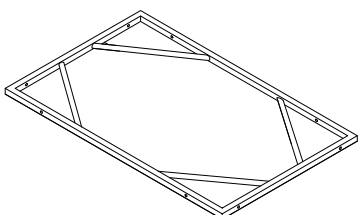
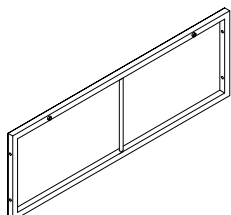
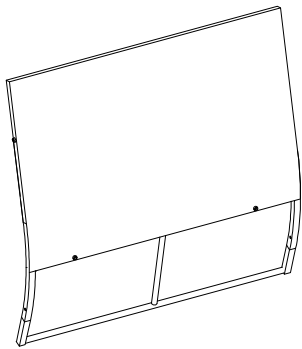
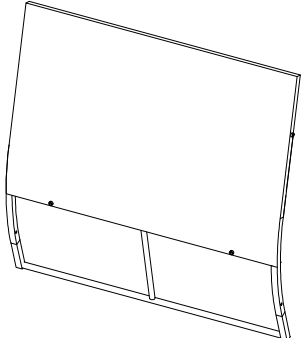
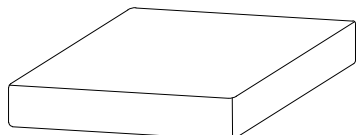
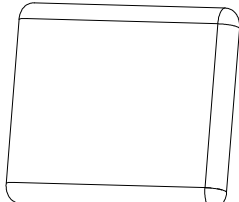
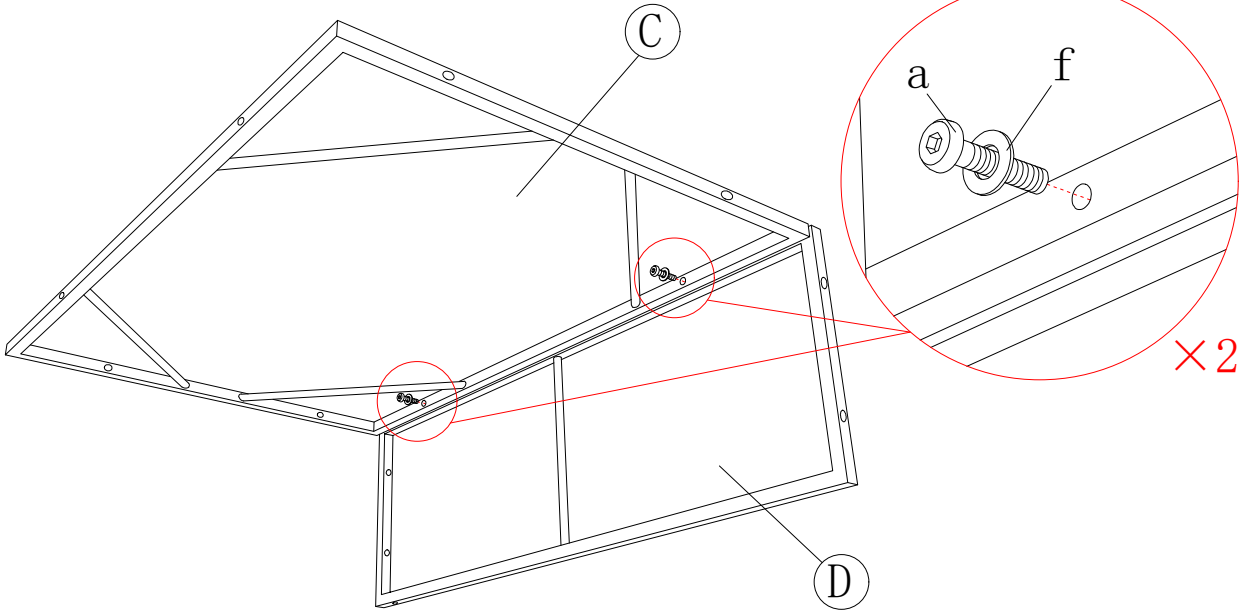
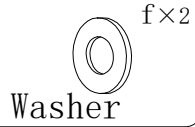
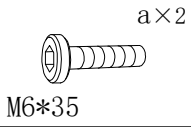
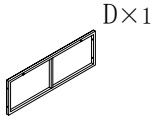
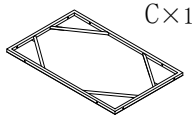
2

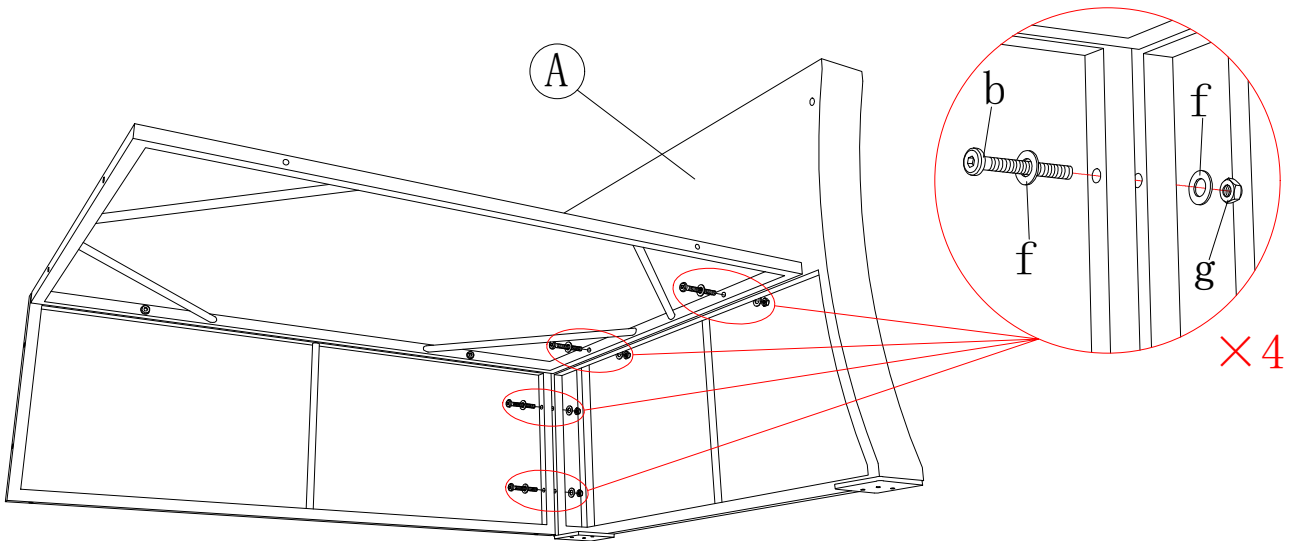
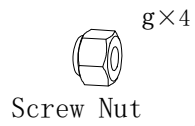
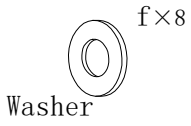
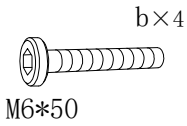
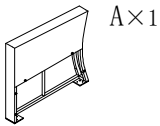

3

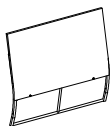

F×1

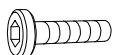

a×2

M6*35



b×1

M6*50



f×4

Washer



g×1

Screw Nut

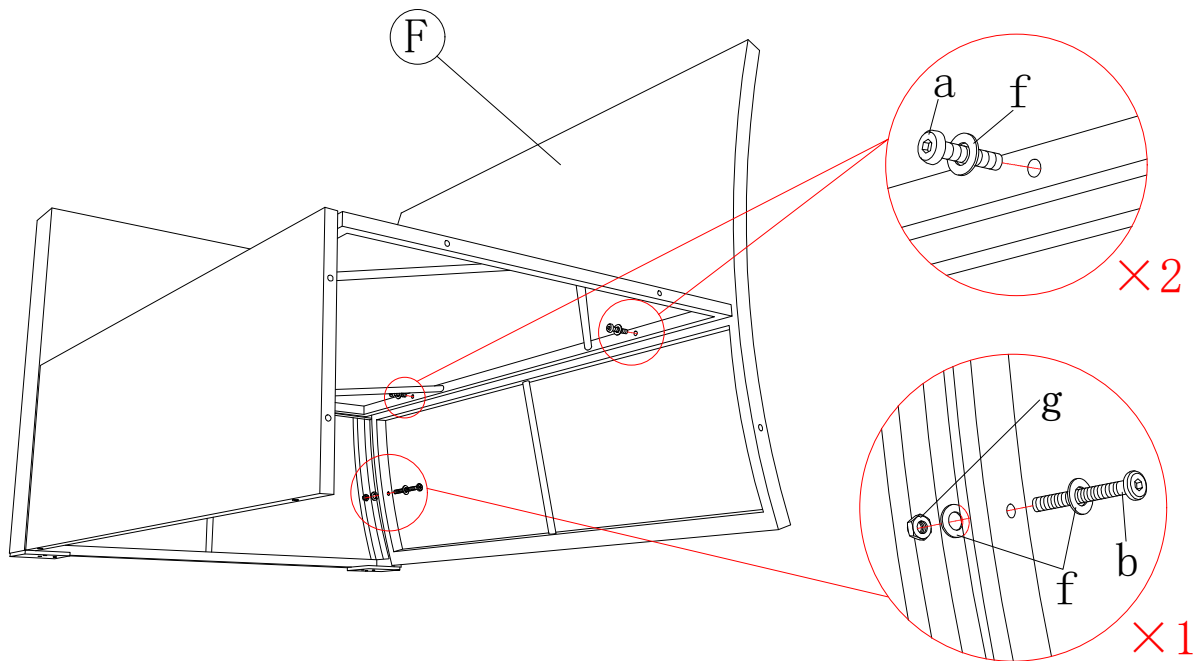

4

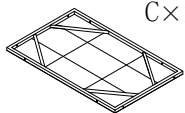

C×1



D×1

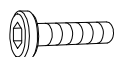

a×2

M6*35



f×2

Washer

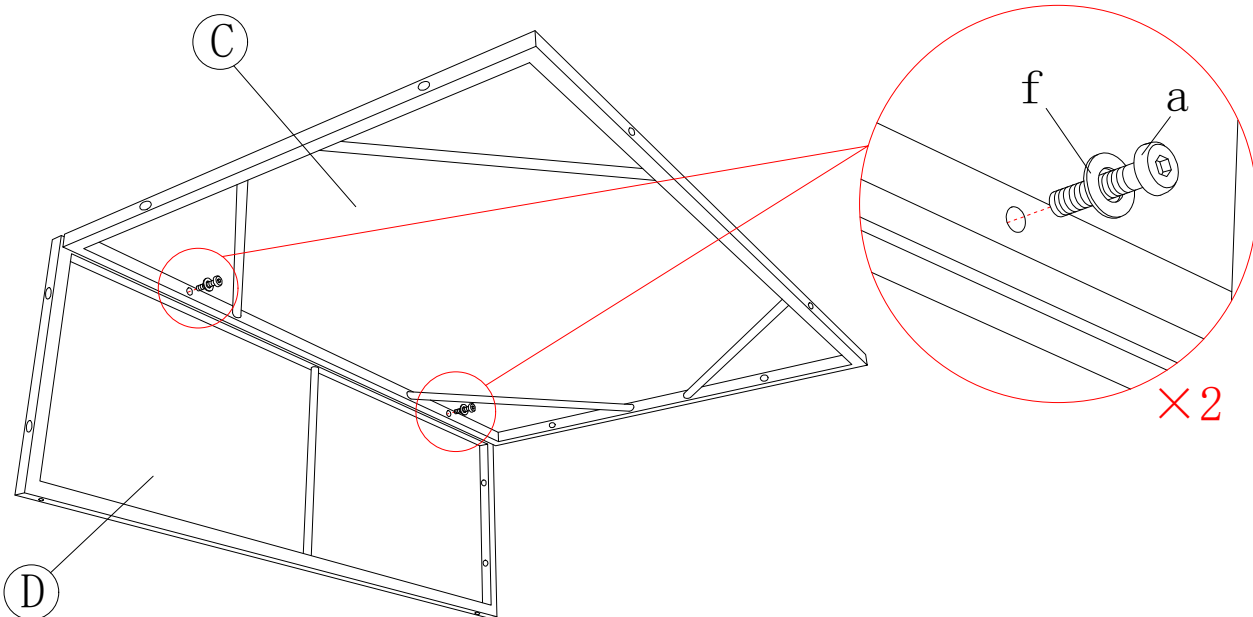

5

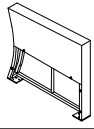

B×1

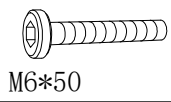

M6*50

b×4



Washer

f×8



Screw Nut

g×4

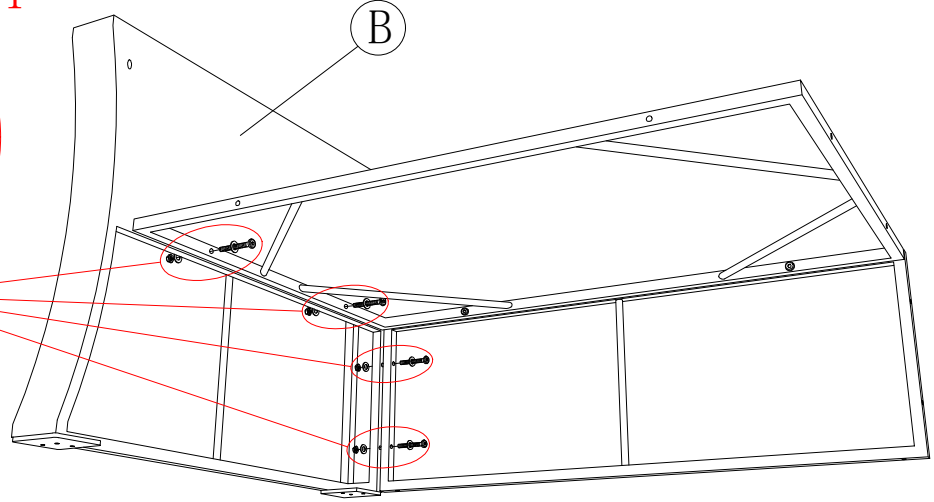
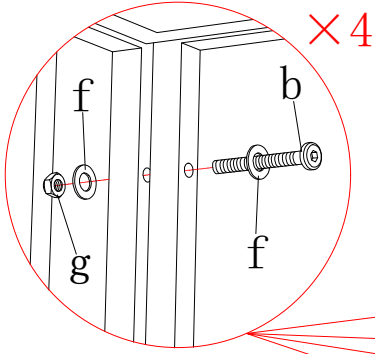

6

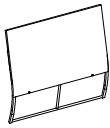

G×1

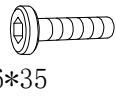

M6*35

a×2

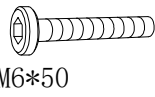

M6*50

b×1



Washer

f×4



Screw Nut

g×1

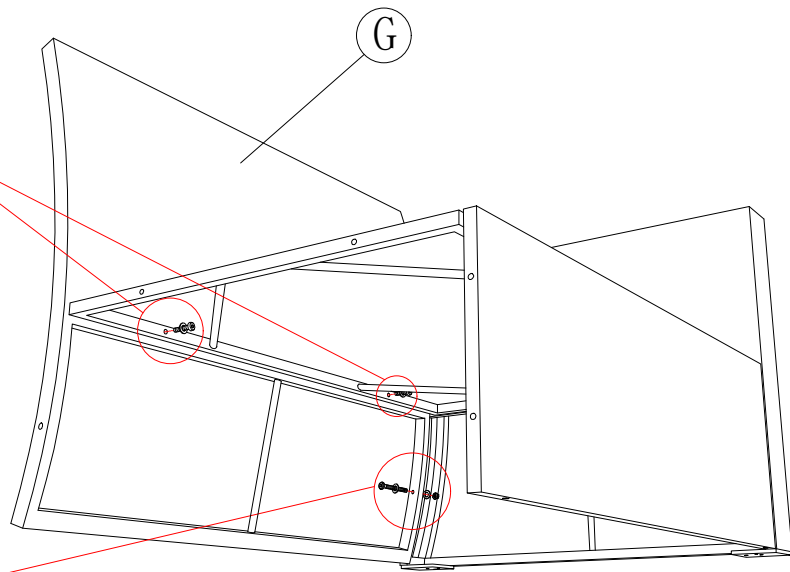
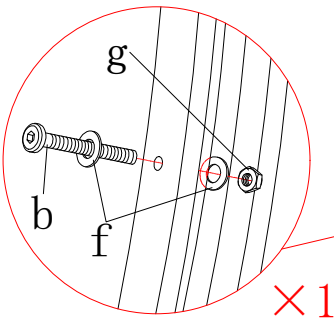
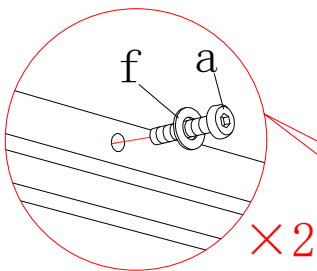

7

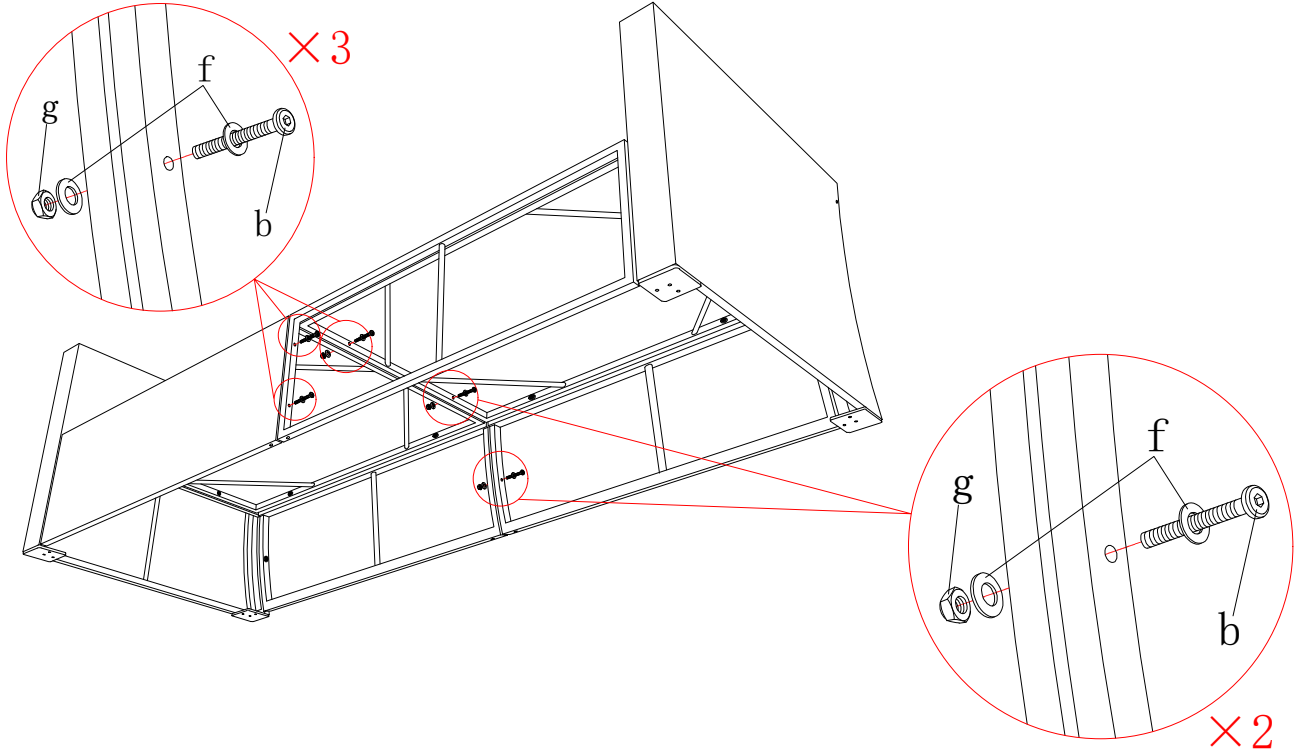
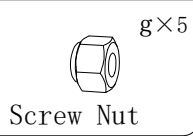
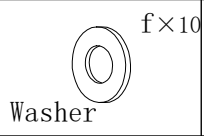
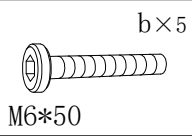

8

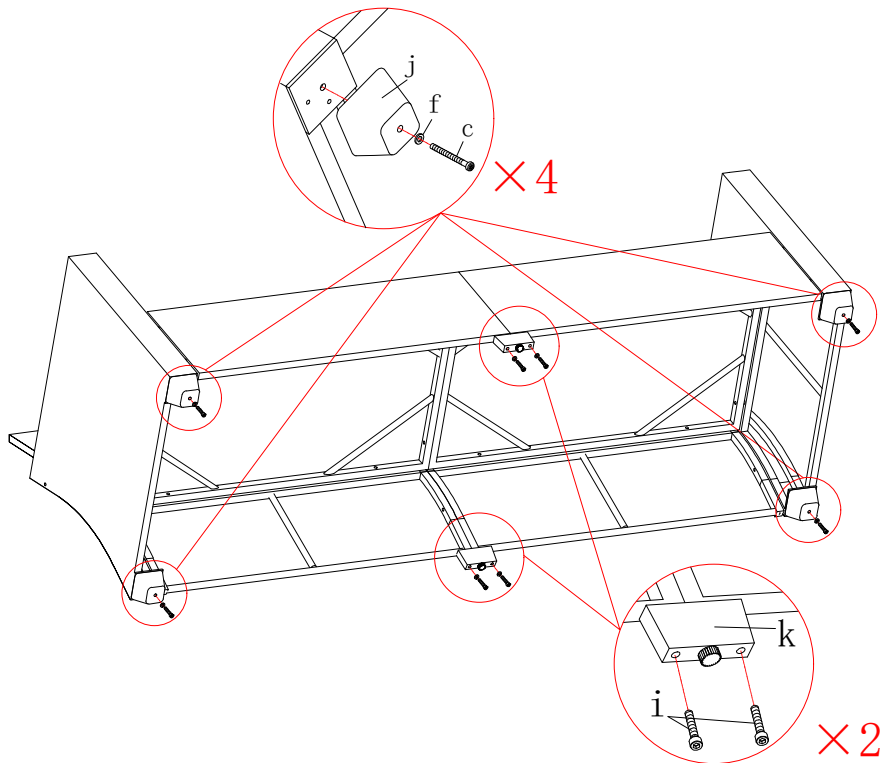
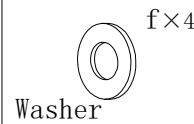
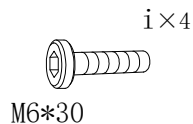
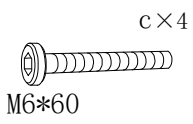
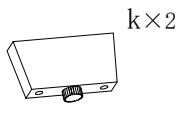
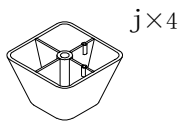

9

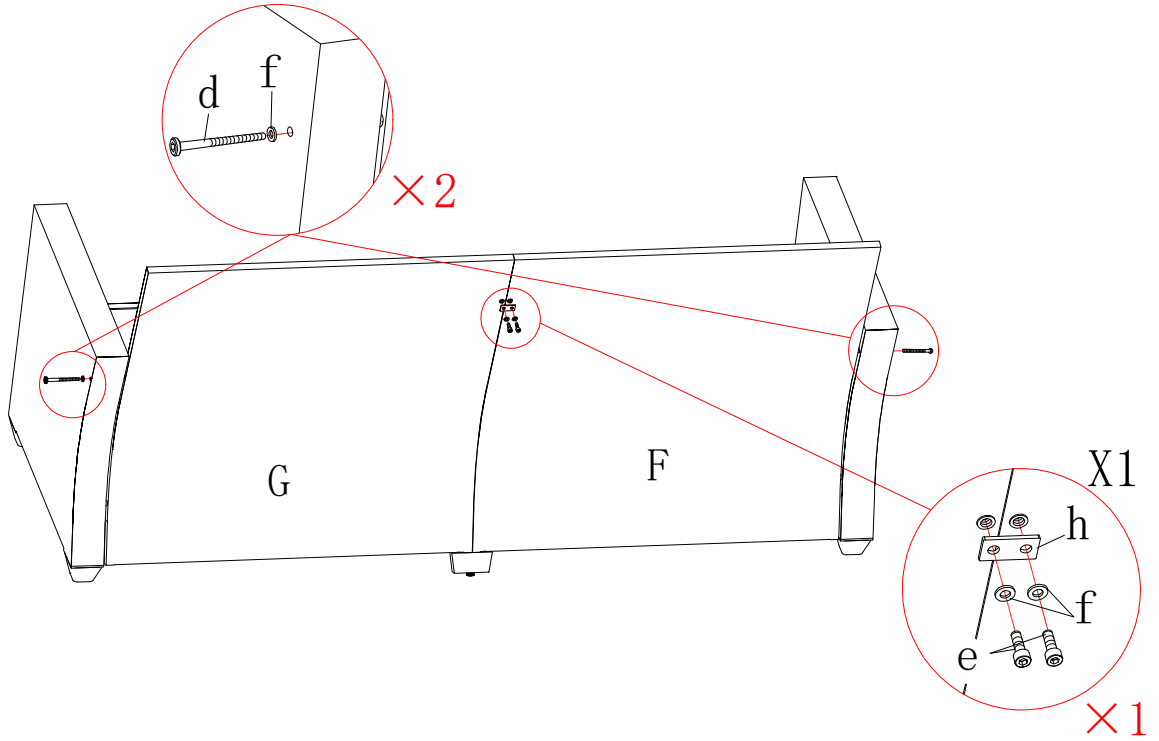
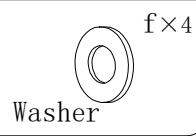
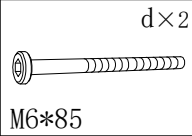
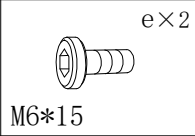
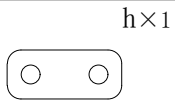

10

