

smart toilet seat

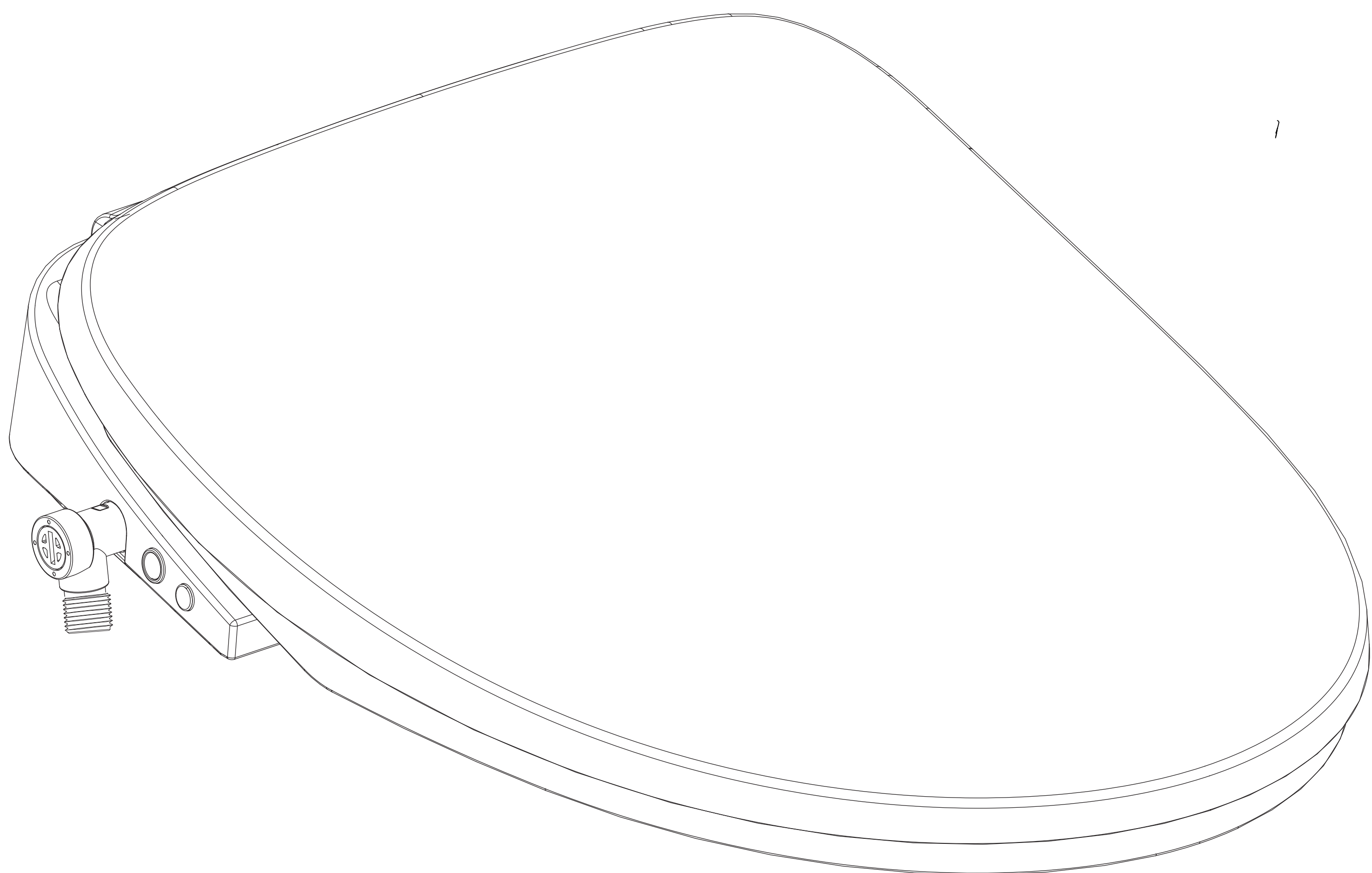

NOTE: Drawings may not exactly define contour of the product.



Prior to Installation:

- Inspect toilet seat to ensure no damages have occurred while in shipping.
- Observe all plumbing and building codes in accordance with your state and local requirements.

General Recommendations:

Please read installation and maintenance instructions thoroughly before installing the toilet seat. Be sure to use proper tools and always wear proper personal safety accessories for your protection.

**If you have any questions or concerns
please contact us:**

(+1) 312-626-9466
service@deervalleybath.com

1. Important Safe Guards

IMPORTANT SAFEGUARDS

When using electrical products, especially when children are present, basic safety precautions should always be followed, including the following:

GROUNDING INSTRUCTIONS

This product must be grounded. In the event of an electrical short circuit, a grounded product reduces the risk of electric shock. This product is equipped with a cord having a grounded wire with a grounded plug. The plug must be plugged into an GFCI outlet that is properly installed and grounded.

DANGER – Improper use of the plug can result in a risk of electric shock.

Check with a licensed electrician or serviceman if the grounding instructions are not completely understood. Or if there is any doubt the product is properly grounded. This product is for use on a nominal AC 120V ± 10%, Max current 10A above, and has a grounded plug that looks like the electrical plug illustrated below.

Grounding Methods

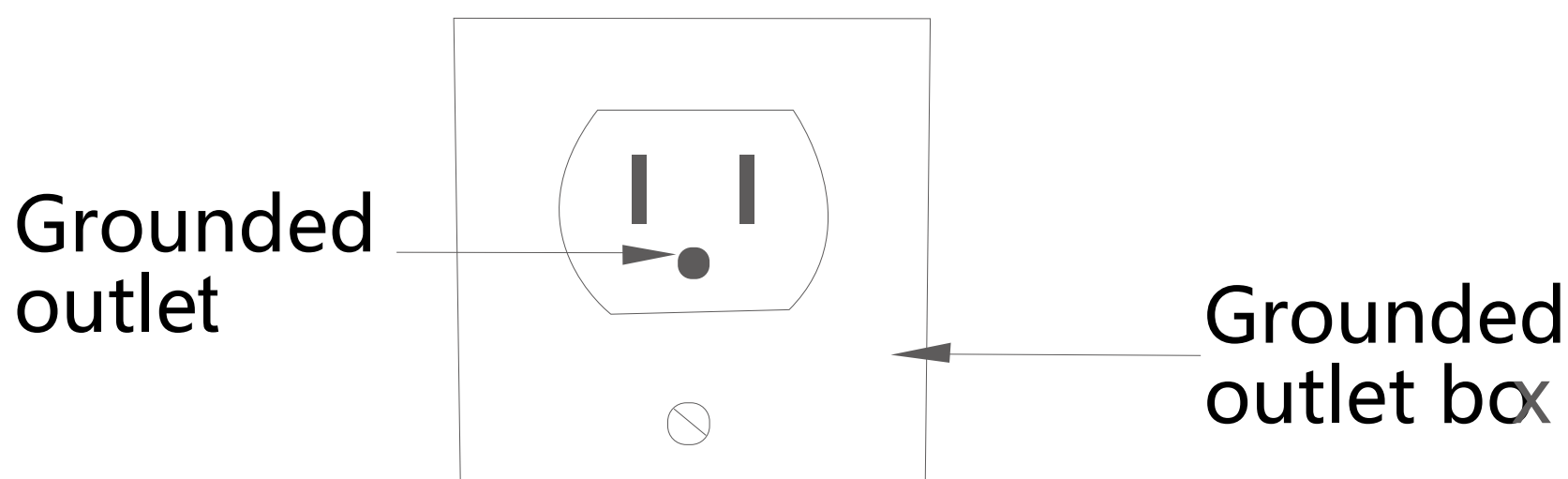
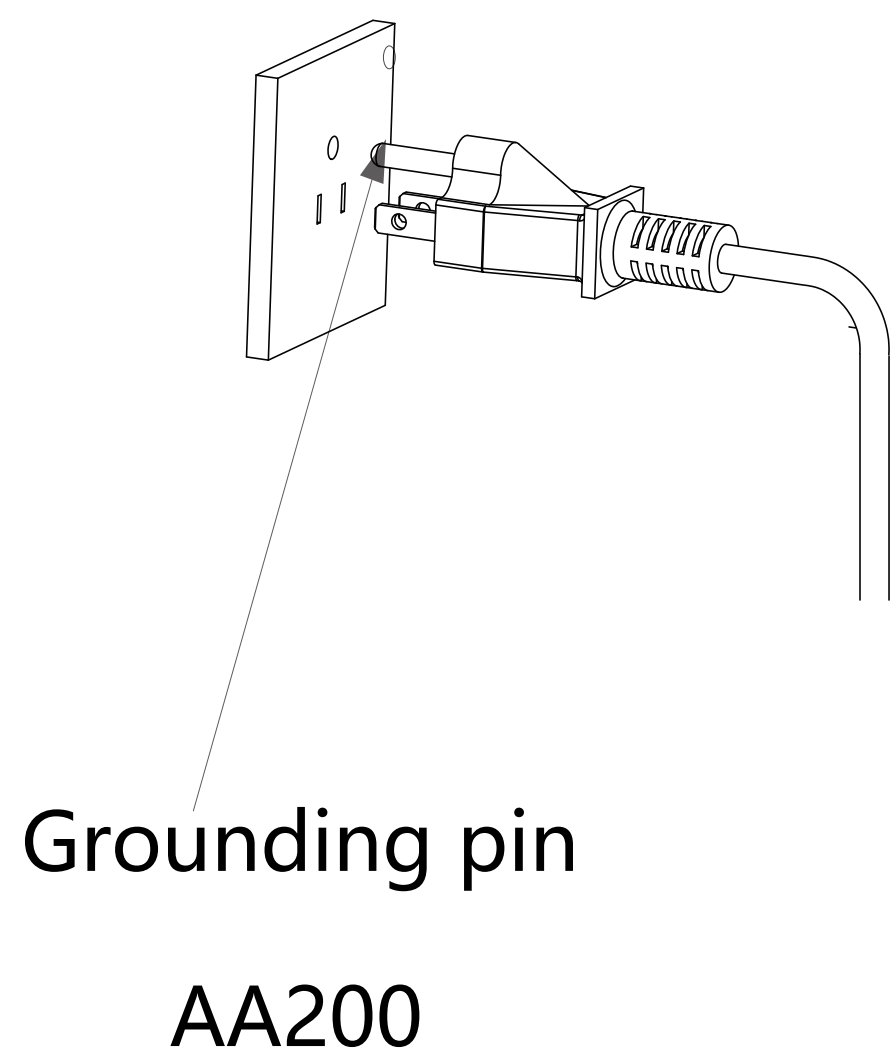

***WARNING: Risk of electric shock Connect only to a circuit that is protected by a ground-fault circuit-interrupter (GFCI).**

Thank you for purchasing our product. Please read this User Manual before installation and use and save it for future reference.

The hazards and warnings listed herein are important to our users' safety. Significant consequences may result from failure to heed warnings.

NOTE: Specialized tools may be necessary to install DeerValley smart toilet seat.

Please carefully read this manual before use and keep for future reference.

The following icons are used in this manual to indicate varying severities of hazards. Please abide by these precautions, otherwise serious consequences may occur.

NOTATION

WARNING Please pay close attention to avoid serious harm or accidents.

ATTENTION If not attentive, body or property damage may result.



. . . . Caution! Comply with guidelines.

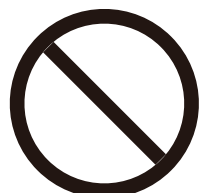

. . . . Prohibited action!

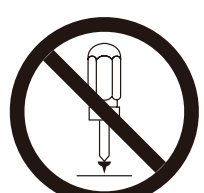

. . . . Do not dismantle!



. . . . Keep away from direct contact with water or any liquid.



. . . . Do not touch this area!



. . . . Do not touch this area with wet hands!



. . . . Keep away from fire!



. . . . Operate as instructed.



. . . . Please unplug!

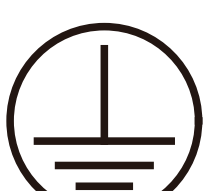

. . . . Please confirm it is grounded!

NOTE: Drawings may not exactly define contour of the product.

 **WARNING**

Make sure the power supply is grounded.

Otherwise, electric shock may occur.

Please consult qualified electrician or serviceman if the power supply is not grounded.

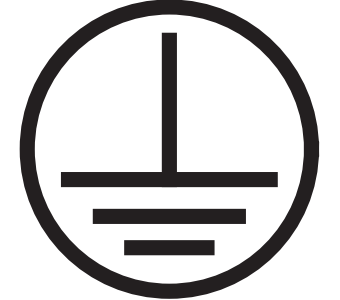

Do not place lit cigarettes or other ignited items on the product.

Otherwise, fire may occur.



Do not touch or plug in the cord with wet hands.

Otherwise, electric shock may occur.



Do not place lit cigarettes or other ignited items on the product.

Otherwise, the device may be damaged or malfunction.

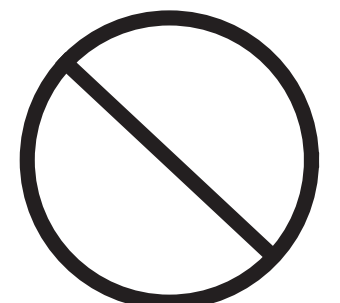

Do not connect power cord if the cord is damaged or broken.

Otherwise, electric shock or fire may occur.

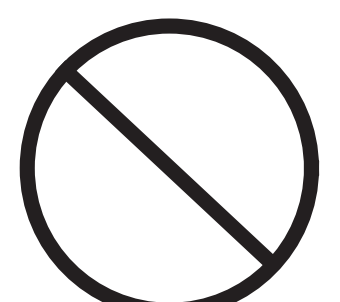

When the seat or lid is broken, please unplug the power and shut down the water supply.

Otherwise, electric shock or fire may occur.



The product must be connected to standard voltage power source (AC120V±10%, Max Current 15A).

Otherwise, electric shock or fire may occur.



NOTE: Drawings may not exactly define contour of the product.

 **WARNING**

Unplug and clean the dust on the power cord with a dry cloth regularly.
Otherwise, fire may occur due to bad insulation.



Individuals who are handicapped (physically, mentally, or emotionally) must be accompanied during use.
Otherwise, prolonged use may cause low temperature burns.



Do not forcefully pull, break, bend, strip, twist, or over squeeze the power cord and cable.
Otherwise, electric shock or fire may occur.

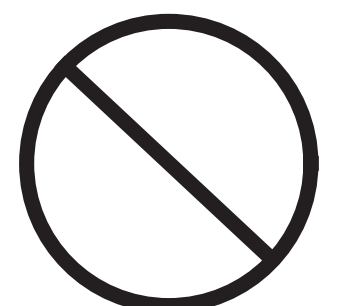

Children should not play with this product.
Otherwise, injury may occur.



The cord must be replaced by authorized personnel
Otherwise, electric shock or fire may occur.



Do not dismantle this product to repair or remodel. Only Authorized personnel such as a qualified electrician should service the product.
Otherwise, malfunctions may cause electric shock, fire, or injury.

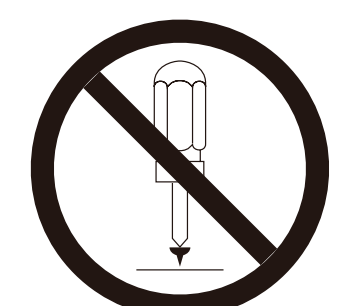

Please avoid installing the product while bathroom is wet. Do not splash water on the product.
Otherwise, electric shock, fire, damage may occur.



NOTE: Drawings may not exactly define contour of the product.

 **WARNING**

Do not urinate on the product.
Otherwise, electric shock may occur.

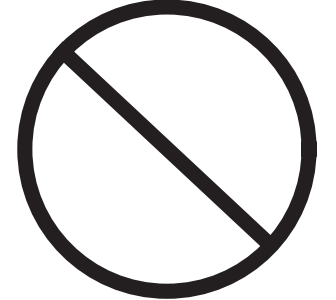

Do not use polluted water supply.
Otherwise, the water may damage the device or harm the user.

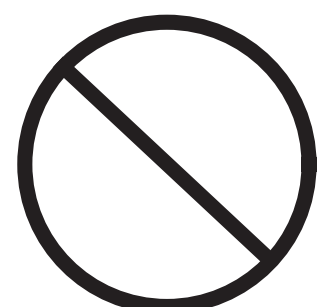

If using any chemical toilet bowl cleaner, be sure to wipe up any spills that splash onto the plastic areas of the product. Do not use any acidic chemical detergent. Only neutral detergents are permitted.
Otherwise, the plastic may break and cause body damage, electric shock, or fire.

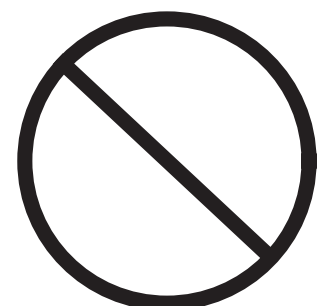

Do not stand, sit, or lean forcefully on the lid of the bidet toilet seat. Do not open or close the lid/seat ring forcefully to avoid damage.

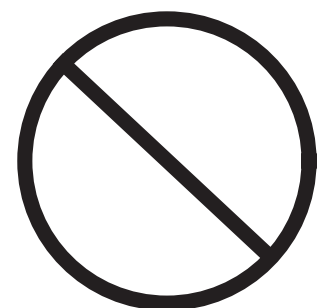

Please do not let water or detergent wet the bidet toilet seat or power plug.
Otherwise, there may be a risk of electric shock or fire.

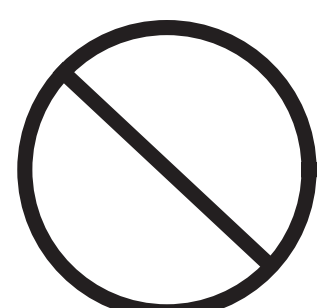

Do not block the dryer door with hands or other objects. Do not cover the door during use.

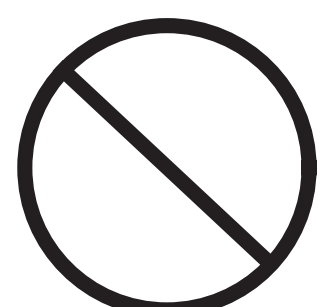

Do not use warm or heated temperature settings for extended periods of time.

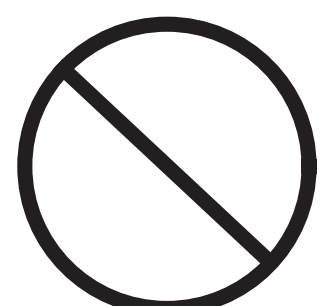

NOTE: Drawings may not exactly define contour of the product.

 **WARNING**

Do not expose to direct sunlight or heating device.

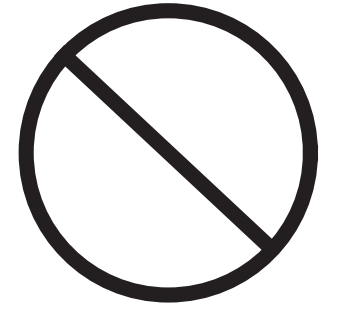

Please make sure the user is fully seated.

Otherwise, the cleaning or drying function will stop.



Do not use a timer power source or external switch to turn the device on/off. The thermal cutoff device may cause danger.

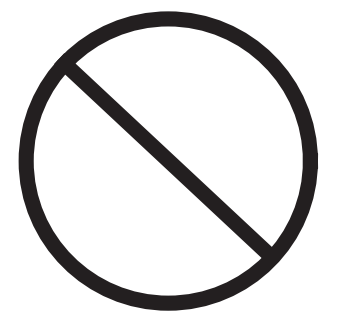

Please turn off the water supply before replacing the filter. Firmly attach the filter before opening the water supply.

Otherwise, leakage or fire may occur.



Do not urinate on the nozzle.

Otherwise, the nozzle may become obstructed.

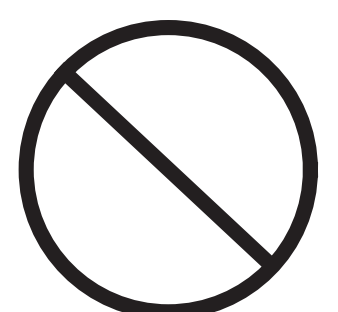

Please unplug and close water sources to the device when away for extended periods of time.

Otherwise, leakage or fire may occur.



Please use provided accessories to install the device. Do not use old parts.

Otherwise, leakage may occur.



NOTE: Drawings may not exactly define contour of the product.

 **WARNING**

During power failure, unplug the device and close the water supply valve to prevent leaking.



In very low temperatures, the water within the device may freeze after long periods of disuse. To avoid damage, please warm the unit to melt the ice.

**WARNING– To reduce the risk of burns, electrocution, fire, or injury;**

1. Close supervision is necessary when this product is used by, on, or near children.
2. Use this product only for its intended use as described in this manual. Do not use attachments not recommended by the manufacturer.
3. Never operate this product if it has a damaged cord or plug, if it is not working properly, if it has been dropped or damaged, or dropped into water.

Return the product to a service center for examination and repair.

1. Keep the power cord away from heated surfaces.
2. Never block the air openings of the product or place it on a soft surface, such as a bed or couch, where the air openings may be blocked. Keep the air openings free of lint, hair, and the like.
3. Never use while sleeping or drowsy.
4. Never drop or insert any object into any opening or hose.
5. Do not use outdoors or operate where aerosol (spray) products are being used or where oxygen is being administered.
6. Connect this product to a properly grounded outlet only. See Grounding Instructions.

NOTE: Drawings may not exactly define contour of the product.

2. Product Installation

(1) Tools needed

Adjustable Wrench (1.02in+ width) **OR** Open End Wrench (0.91-1.02in)

Phillips ⊕ Screw Driver

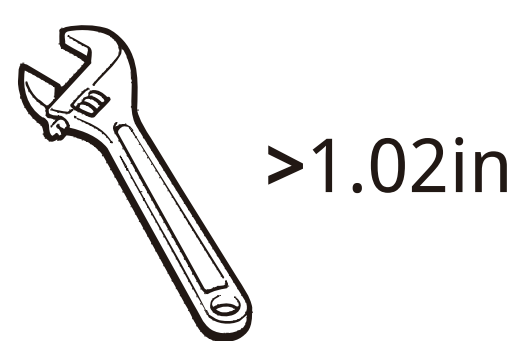

OR

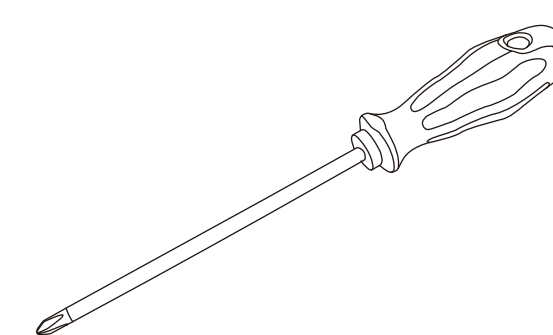
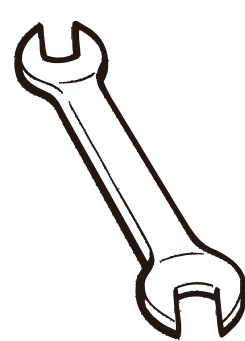

(2) Parts included

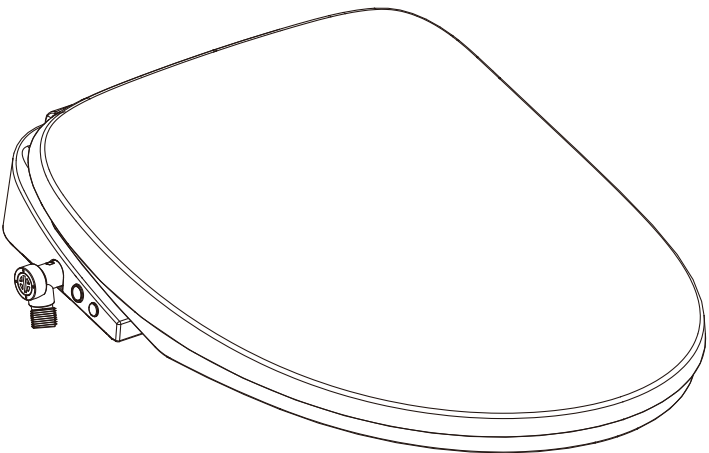
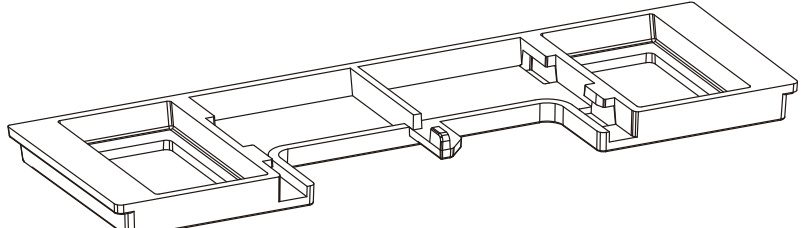
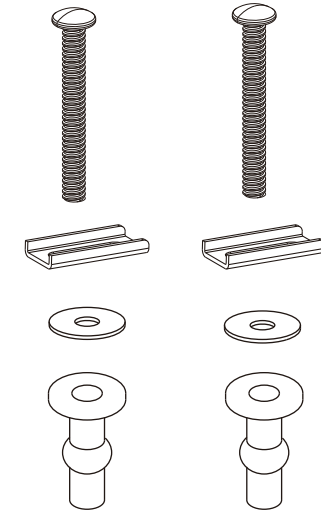
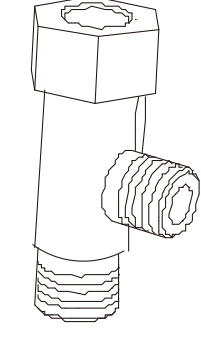
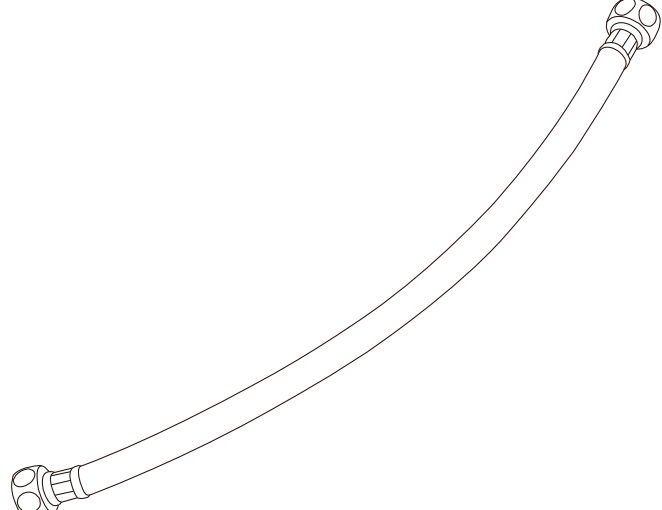
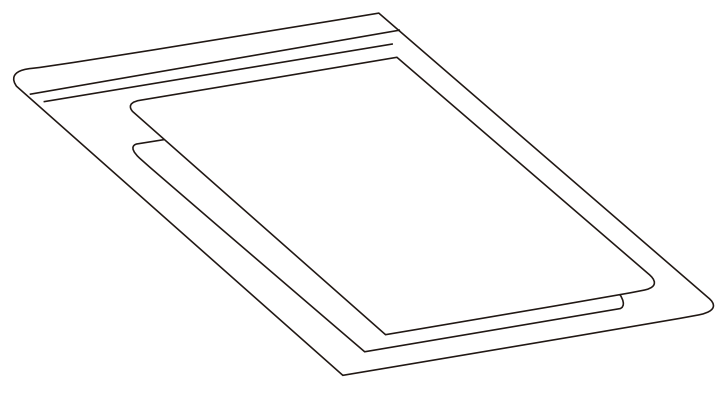
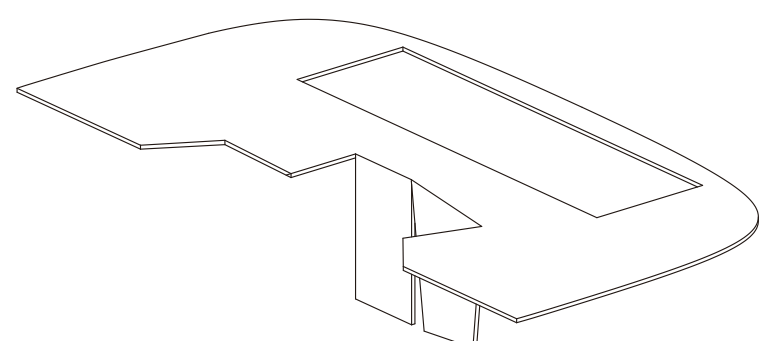
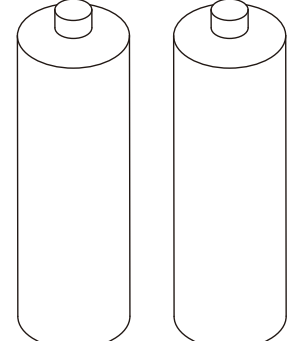
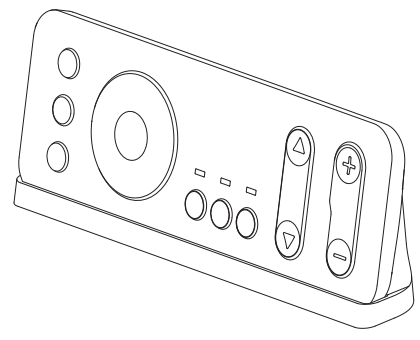
<p>Smart Bidet (1 set)</p> 	<p>Catch Plate (1 pc)</p> 	<p>Screw components (1 sets)</p>  <p>Screw Adjustment Plate Metal Washer Inflated tube</p>
<p>T-valve (1 pc)</p> 	<p>Hose (1 pc)</p> 	<p>Owner's Manual (1 pc)</p> 
<p>Fixed Card (1 pc)</p> 	<p>AAA Battery(2 pcs)</p> 	<p>A Remote Control</p>  <p>With a holder, two expansion screw</p>

After opening the package, please confirm that you have received all parts listed above. If you are missing any parts, please contact us.

NOTE: Specialized tools may be necessary to install DeerValley smart toilet seat.

3. Parts Diagram

(1) Product overview

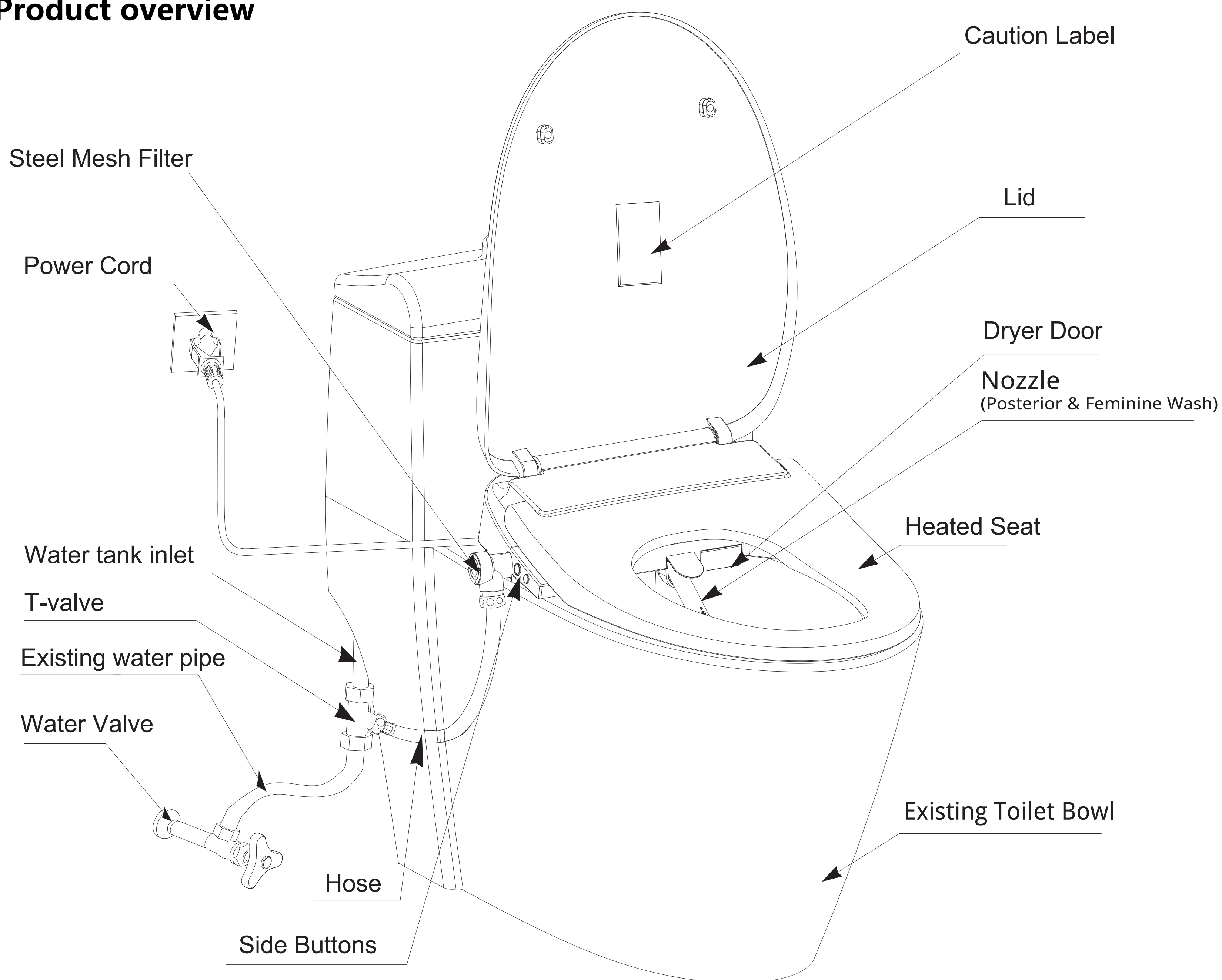

VIEW FROM THE RIGHT

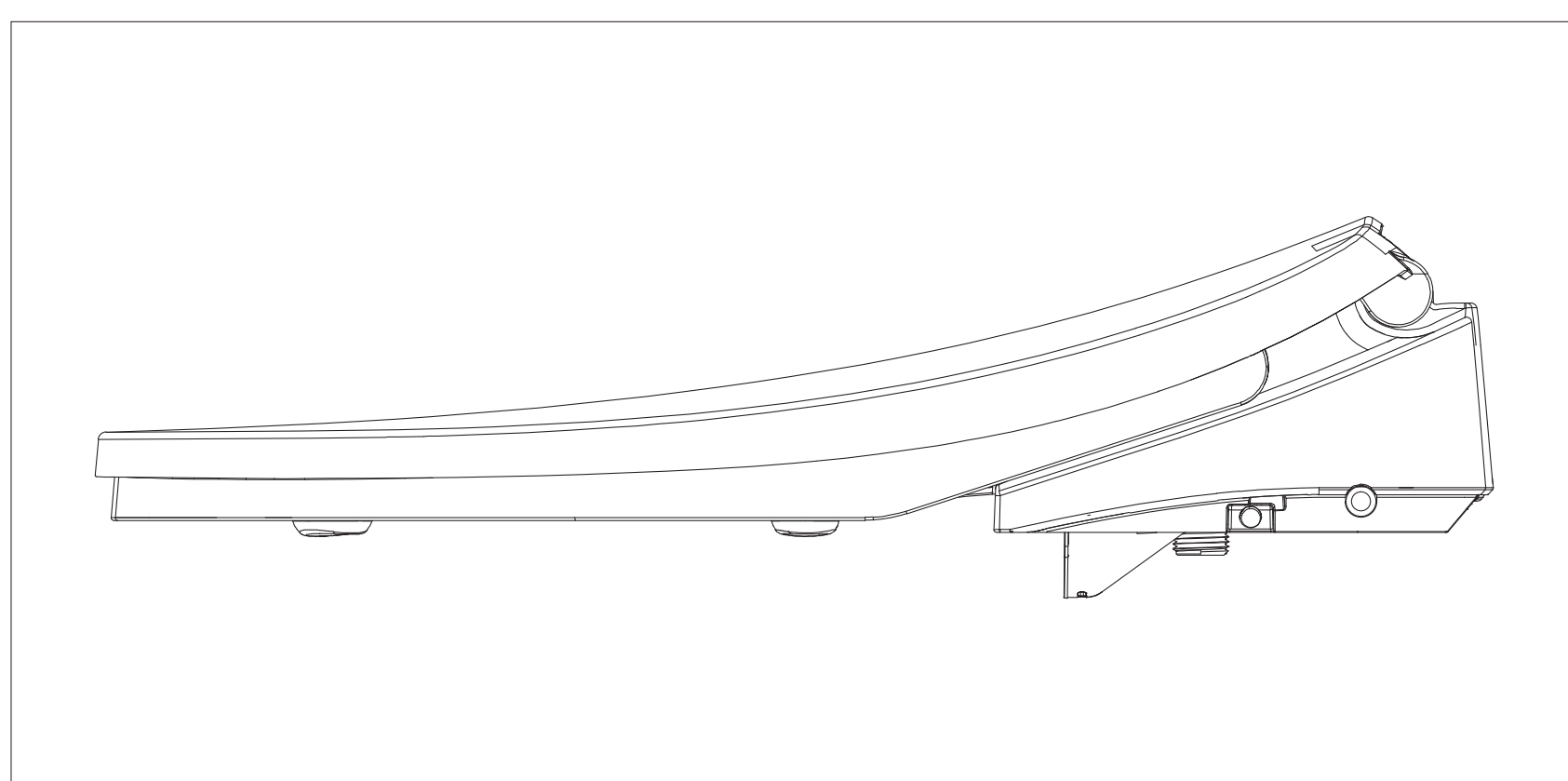

VIEW FROM THE LEFT

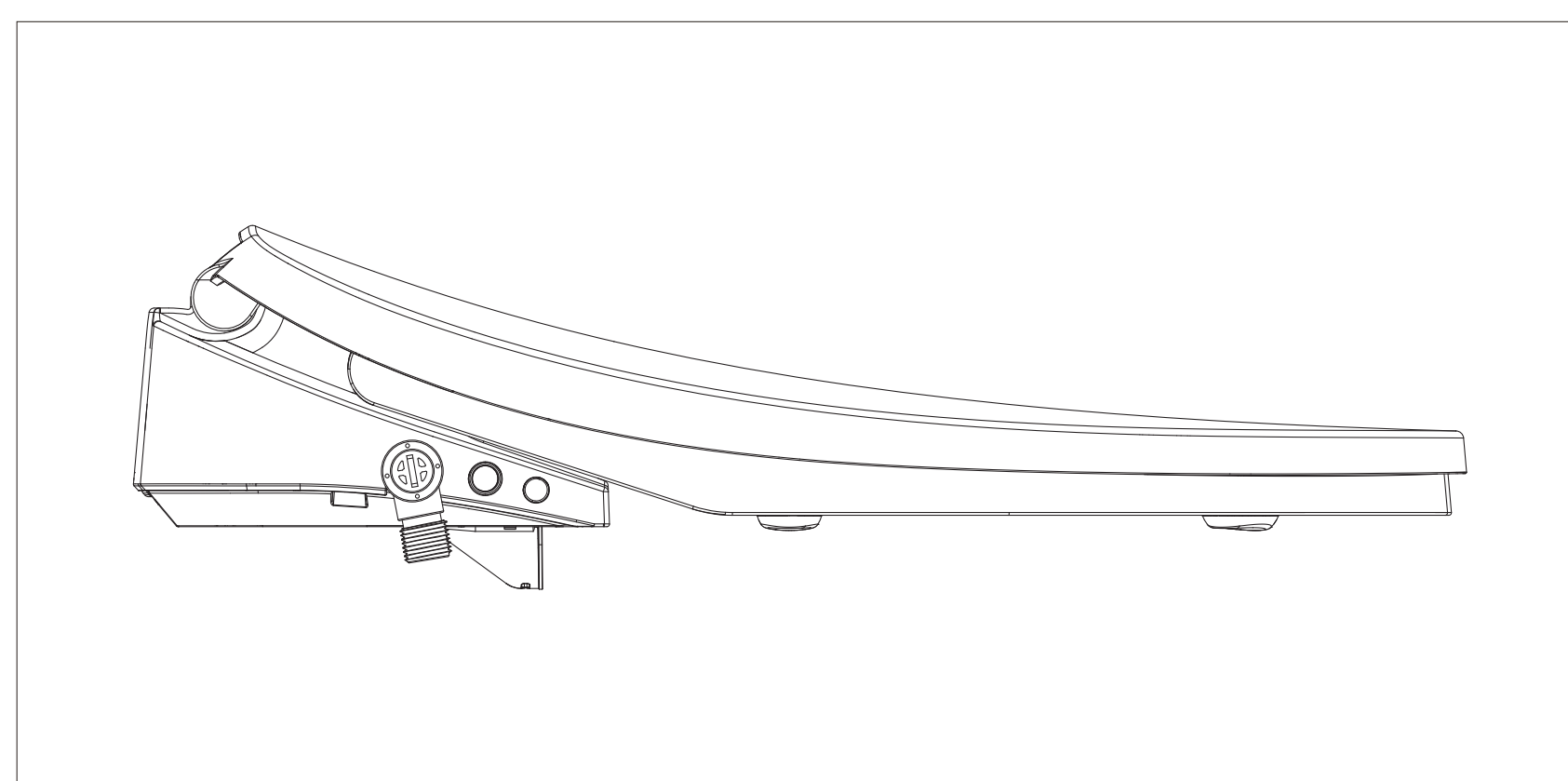

NOTE: Specialized tools may be necessary to install DeerValley smart toilet seat.

(2) Control panel

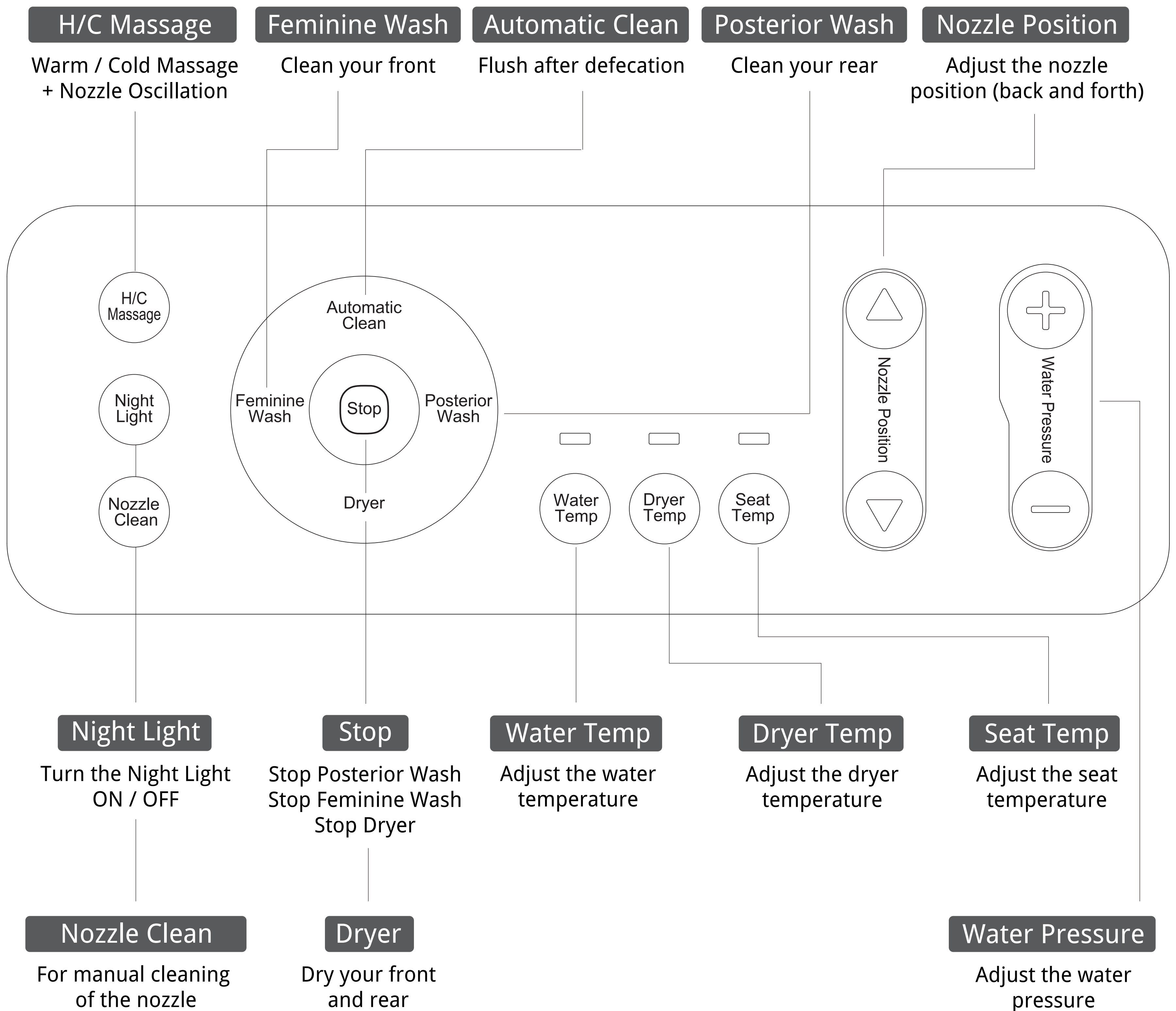

NOTE: Specialized tools may be necessary to install DeerValley smart toilet seat.

(3) Before Installation

Power Requirements

- ▶ The power rating should be within the required range (AC 120V \pm 10%, Max current 10A above)
- ▶ The power outlet should be close enough to reach the power cord (47.24in) but far from where water can hit it.
- ▶ This product must be grounded.
 - The wiring should be installed by a professionally licensed electrician.
 - Please do not plug in the product before installation is complete to prevent malfunction.

Water Requirements

- ▶ The minimum dynamic water pressure required is 0.08MPa.
- ▶ The maximum static water pressure required is 0.8MPa.
- ▶ Water pressure below the min and max range above will affect the performance of the product.

Sizing Requirement

- ▶ Please measure your toilet to make sure that there is enough space for the bidet (20.4 in long).

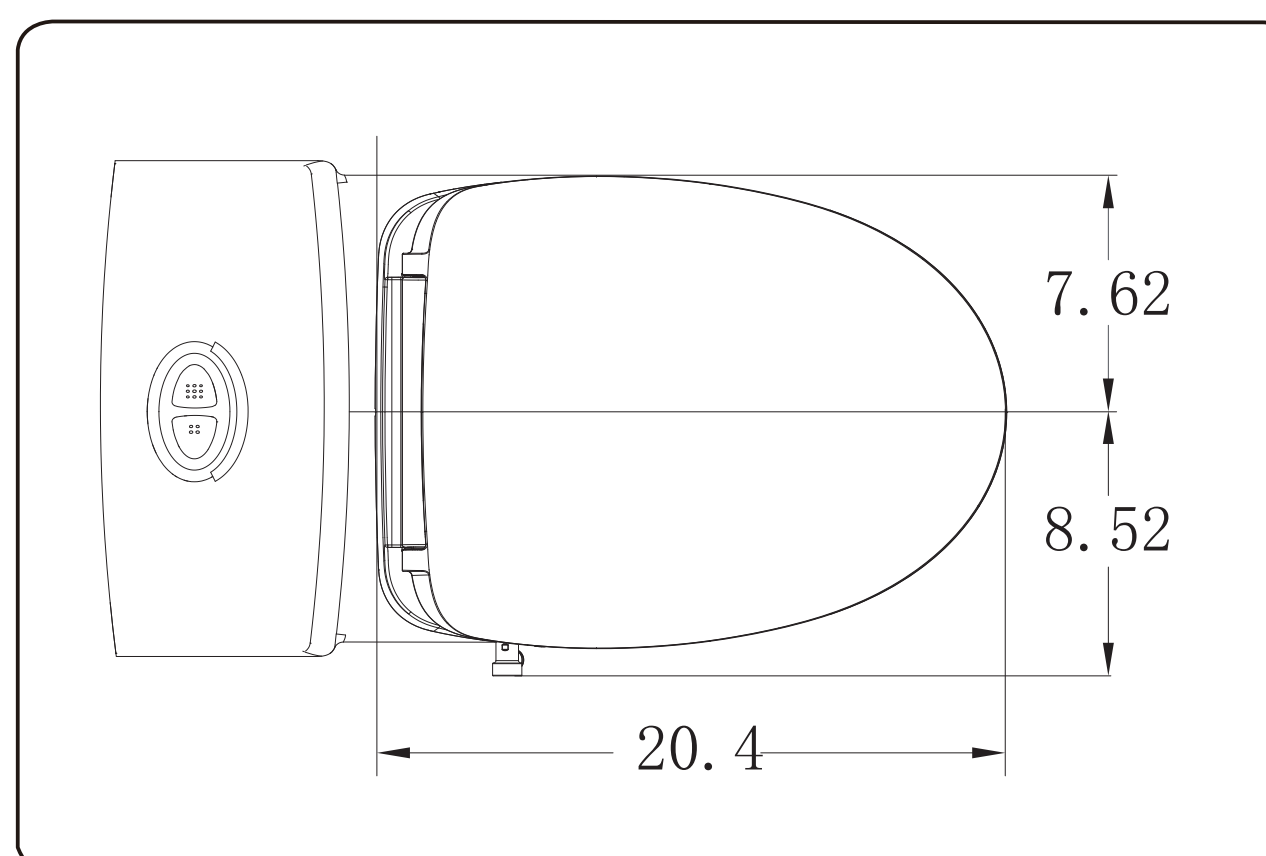

- ▶ The distance between the 2 mounting holes must be within 4.72-6.89 in.
- ▶ The distance from the filter to the bidet inlet should be 23.62 in or less.
- ▶ The distance between the mounting holes and the edge of the toilet bowl must be within 17.99-19.72 in.

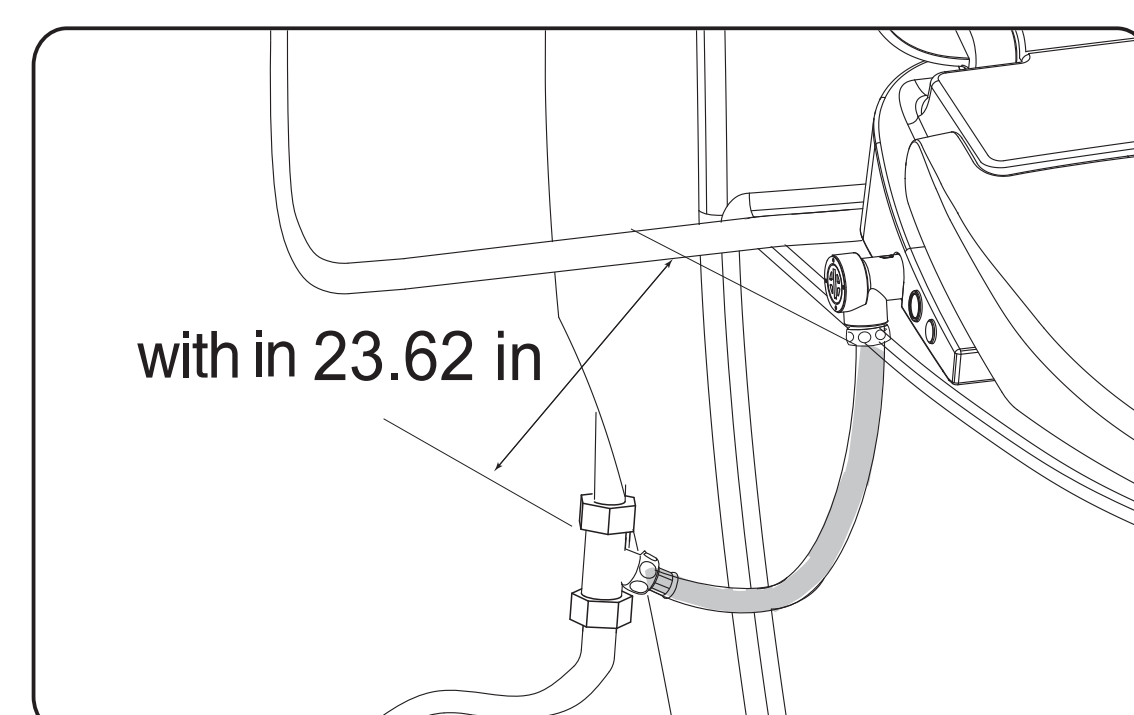
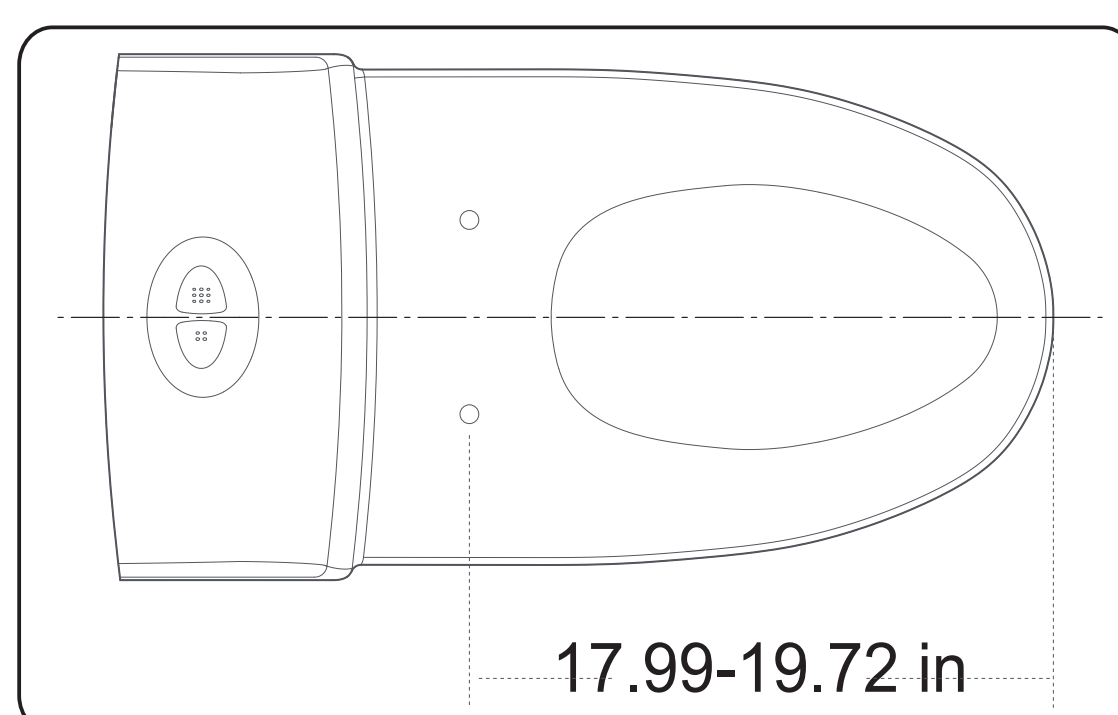
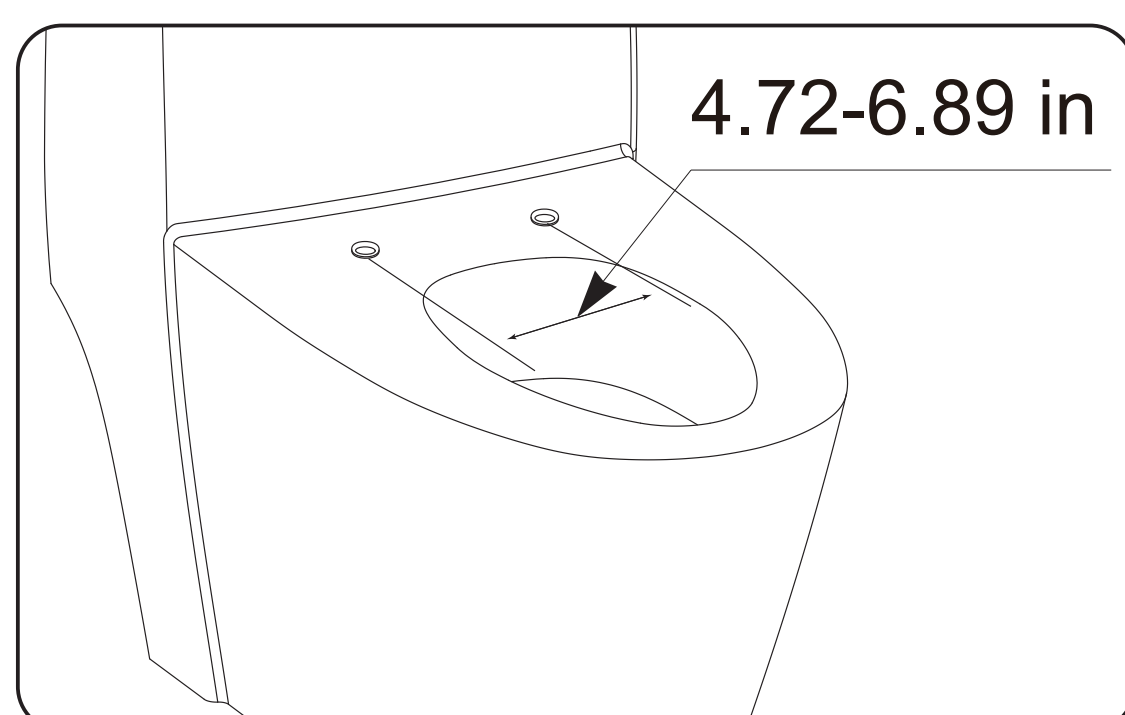

The product has no Ground Fault Circuit Interrupter, It should be installed in the line with Ground Fault Circuit Interrupter, Otherwise, the accidental failure of this product may result

NOTE: Specialized tools may be necessary to install DeerValley smart toilet seat.

4. Installation The Smart Toilet Seat

(1) Remove the existing toilet seat.

- Remove the toilet seat mounting bolts.
- Remove the existing toilet seat from the toilet.

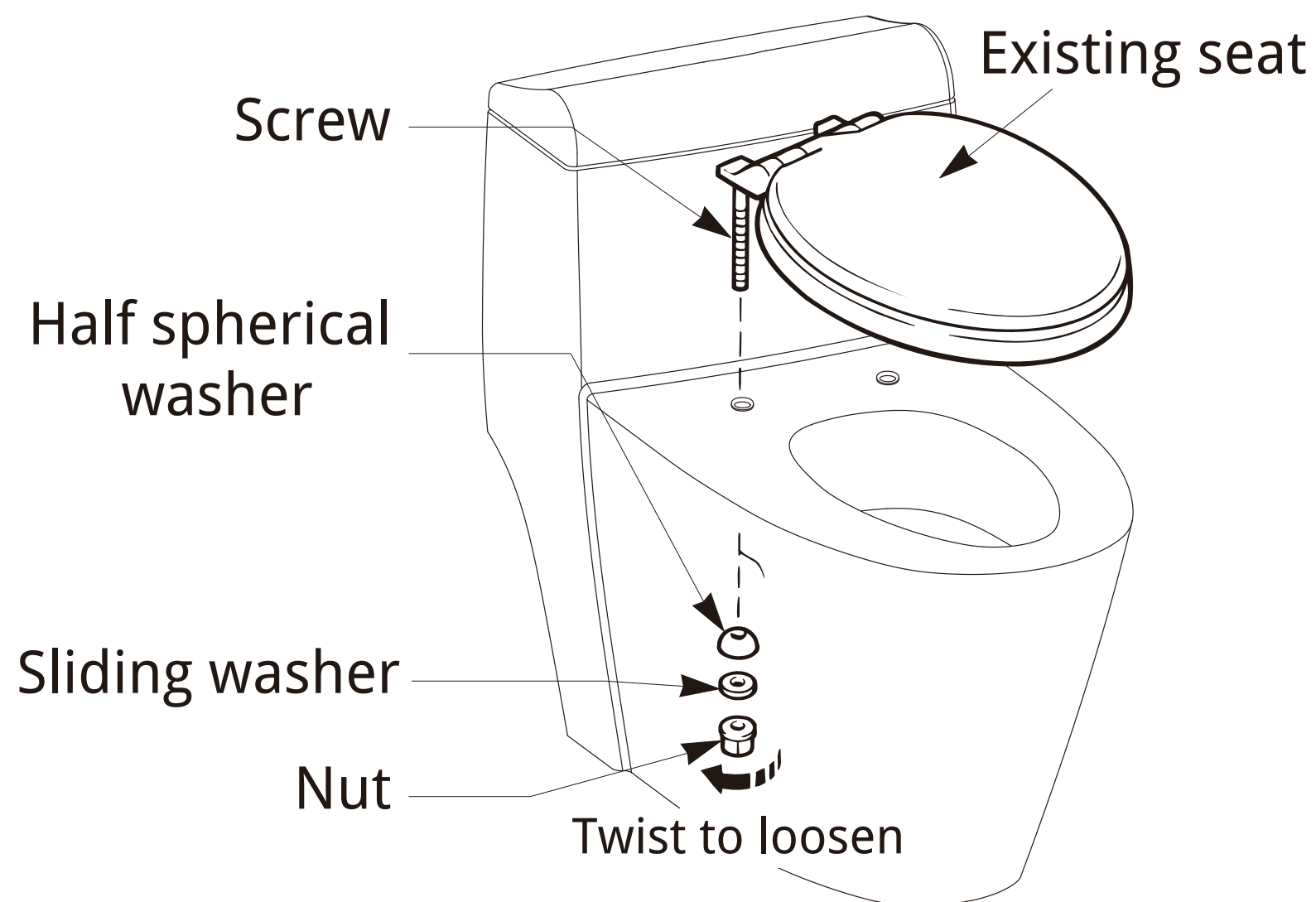

(2) Insert the inflated rubber tube set into the mounting holes on the toilet bowl.

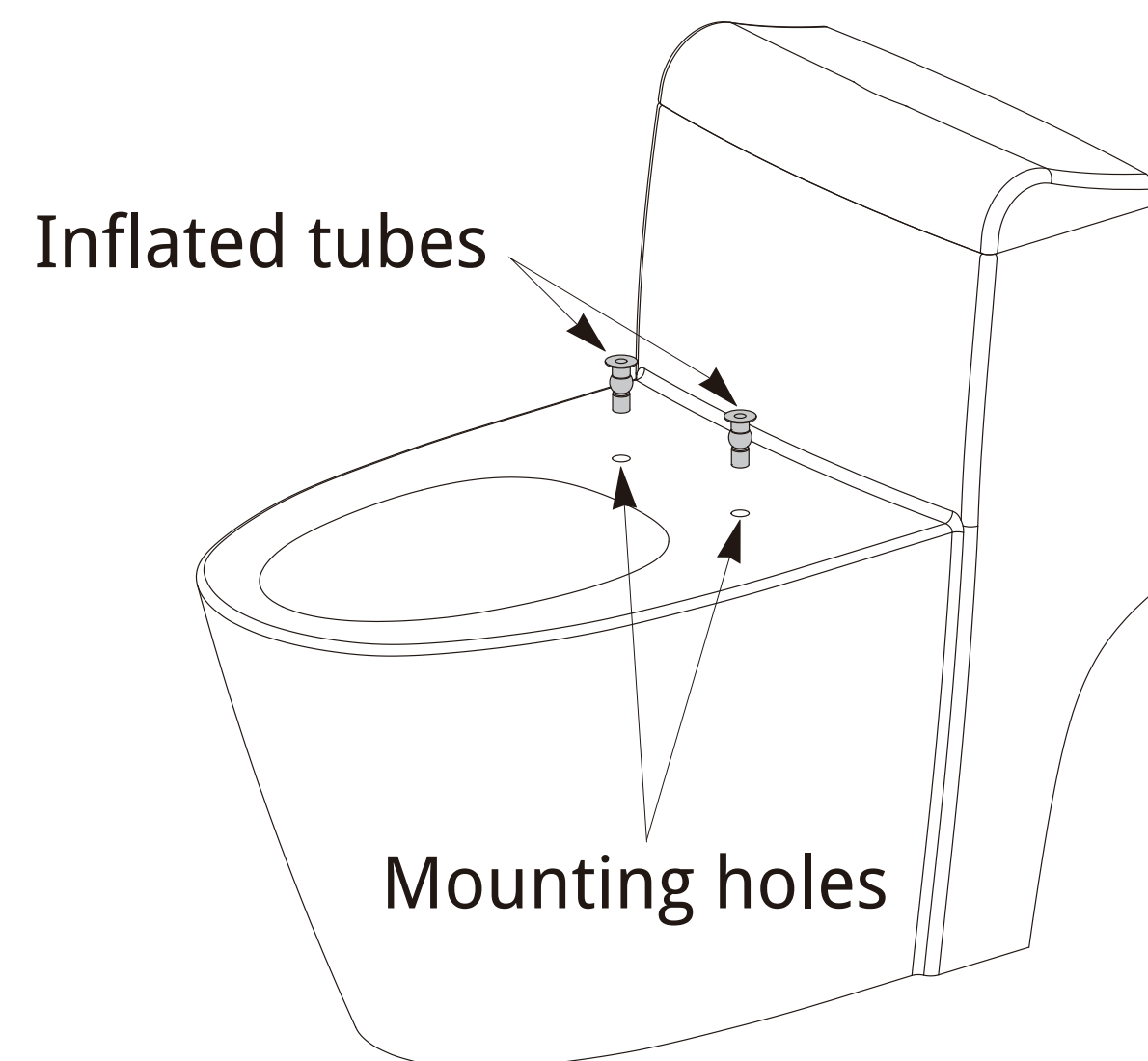

(3) Place the Fixed Card on the toilet bowl where the mounting holes are. Make sure that the wash/dry gates are close to the rim and pointed down.

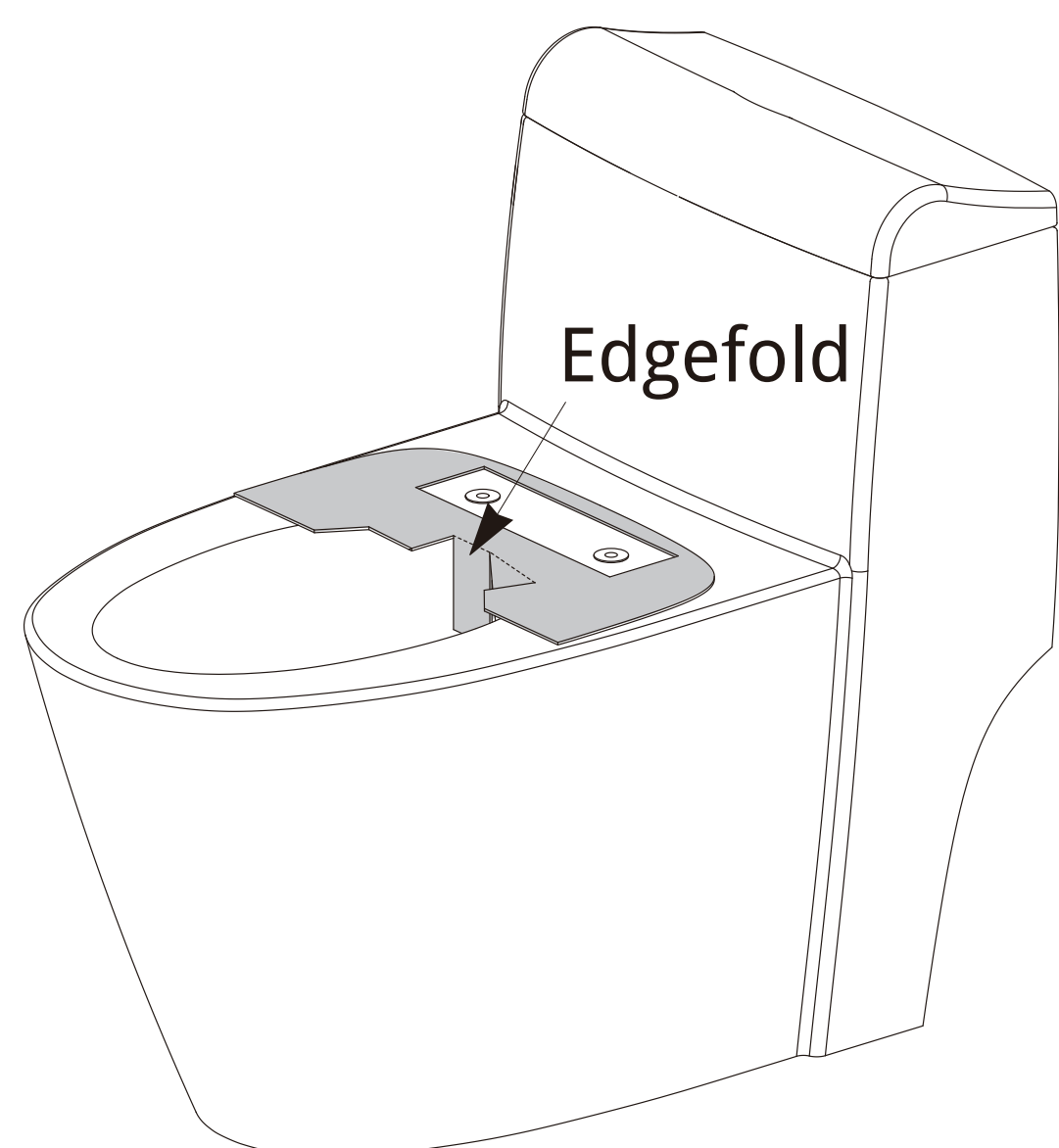

(4) Install the Catch Plate

- Cover with a metal washer.
- Place the ceramic fixing plate in a rectangular box vertically centered on the mounting paper card.
- Cover with metal adjusting sheet.
- Tighten the screws using the large screws.

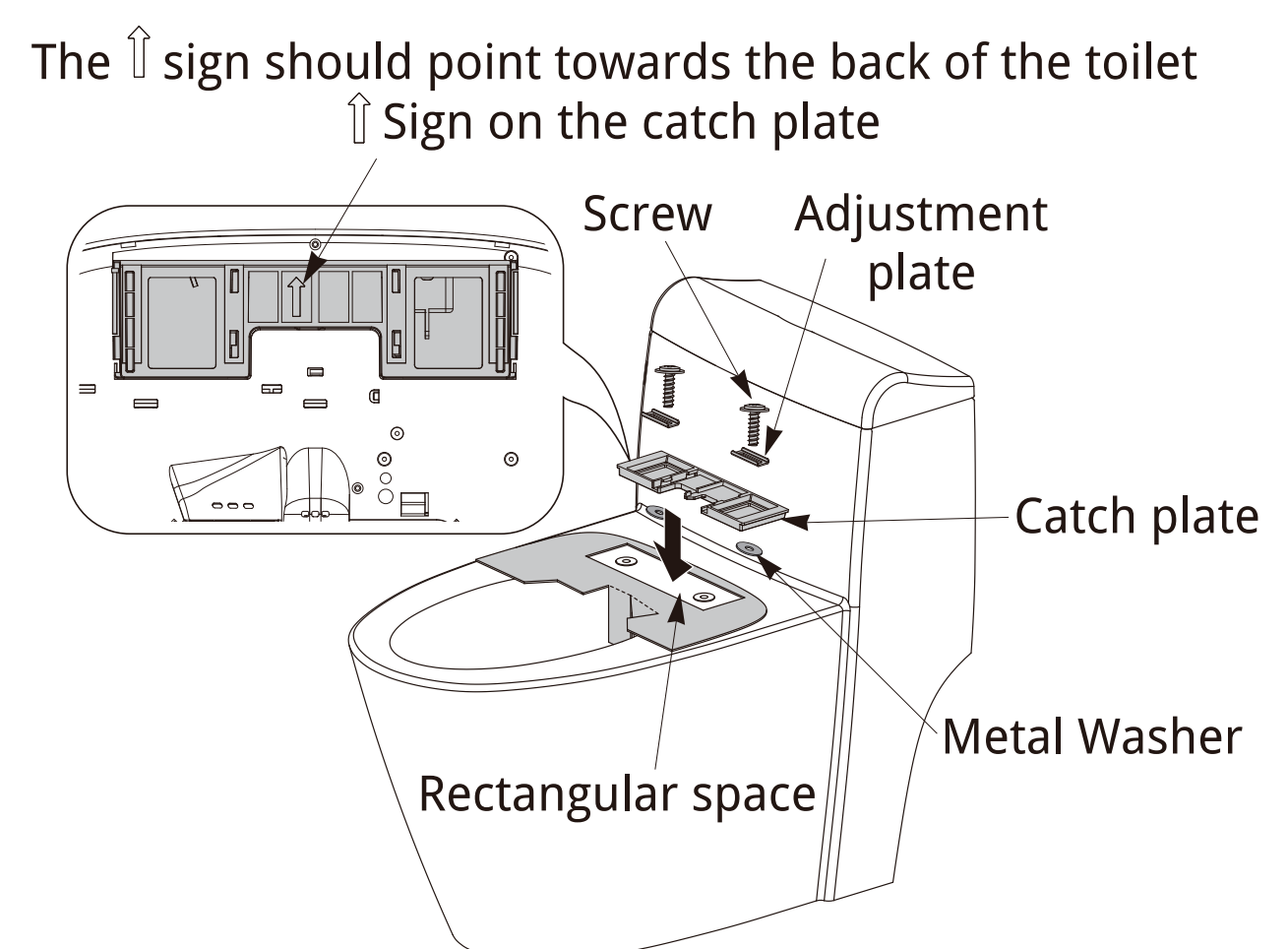

NOTE: Specialized tools may be necessary to install DeerValley smart toilet seat.

(5) Install the smart toilet seat

- Remove Fixed Card.
- Press the push rod button and slide the seat into the Catch Plate.
- Adjust the position of the seat and loosen the screws to adjust position, if necessary.

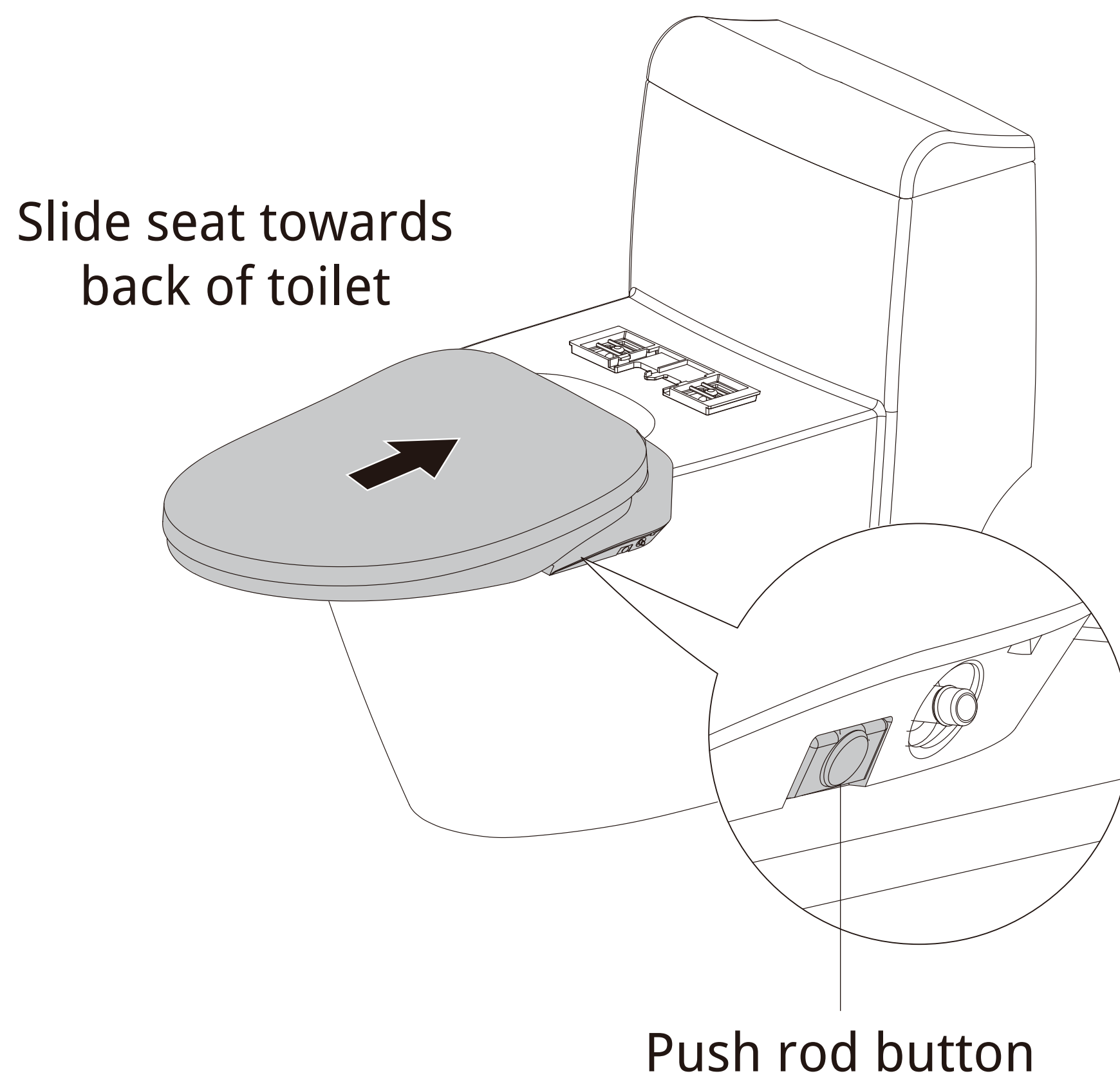

NOTE: Specialized tools may be necessary to install DeerValley smart toilet seat.

5. Installation Steps (cont.)

- Install the filter and hoses

1. Connect T-valve to tank.

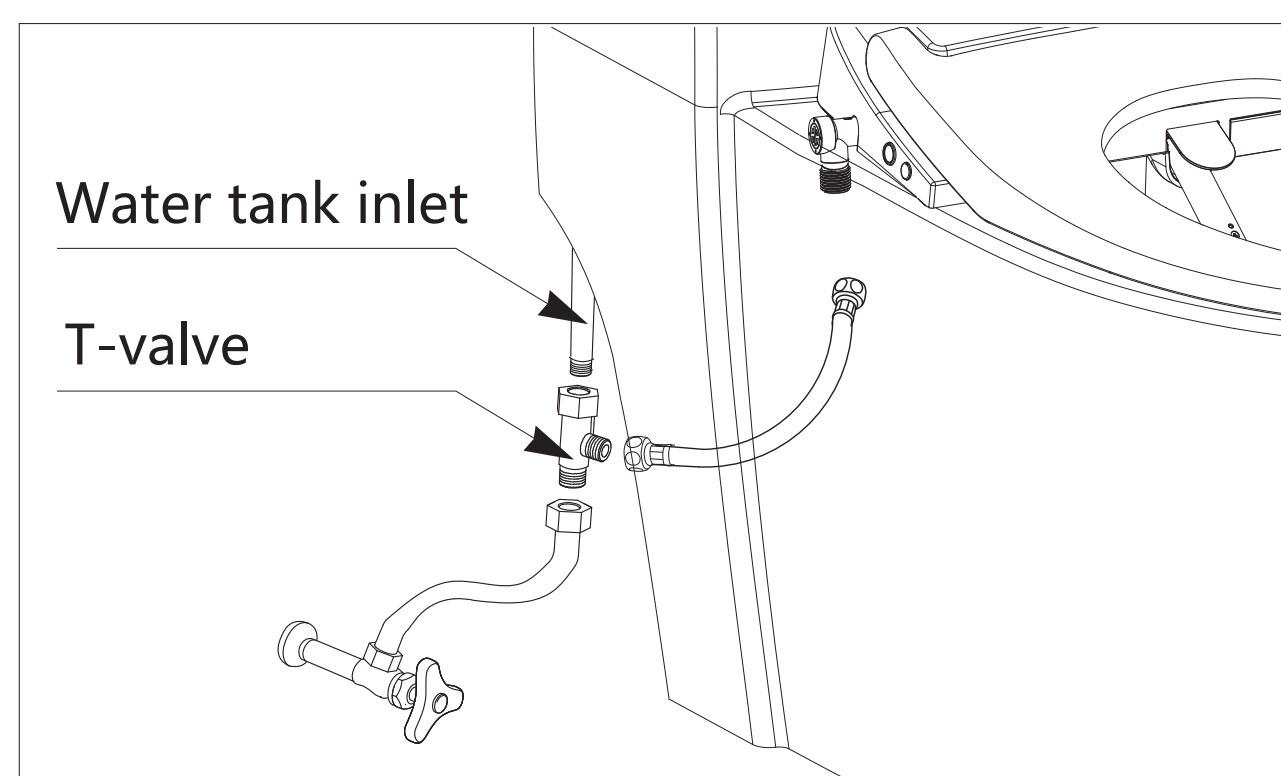

2. Existing water pipe connect T-valve.

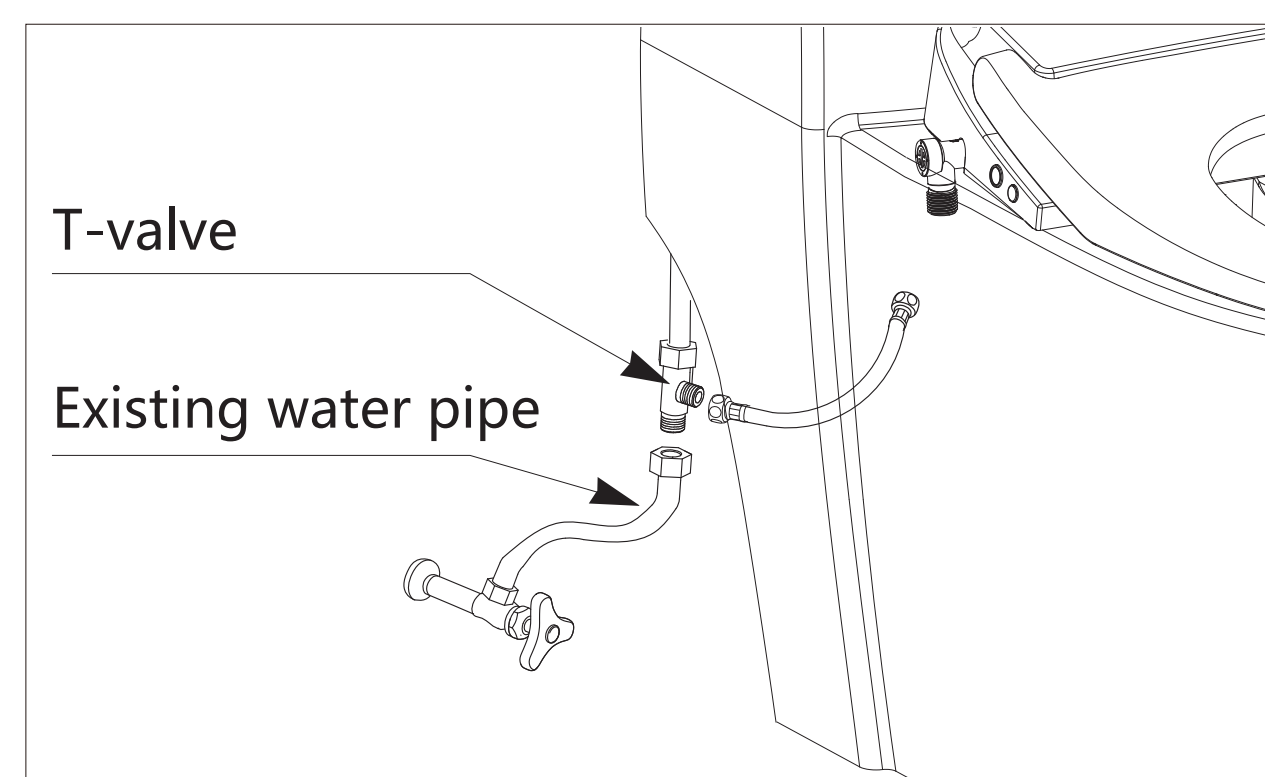

3. Connect the hose to T-valve.

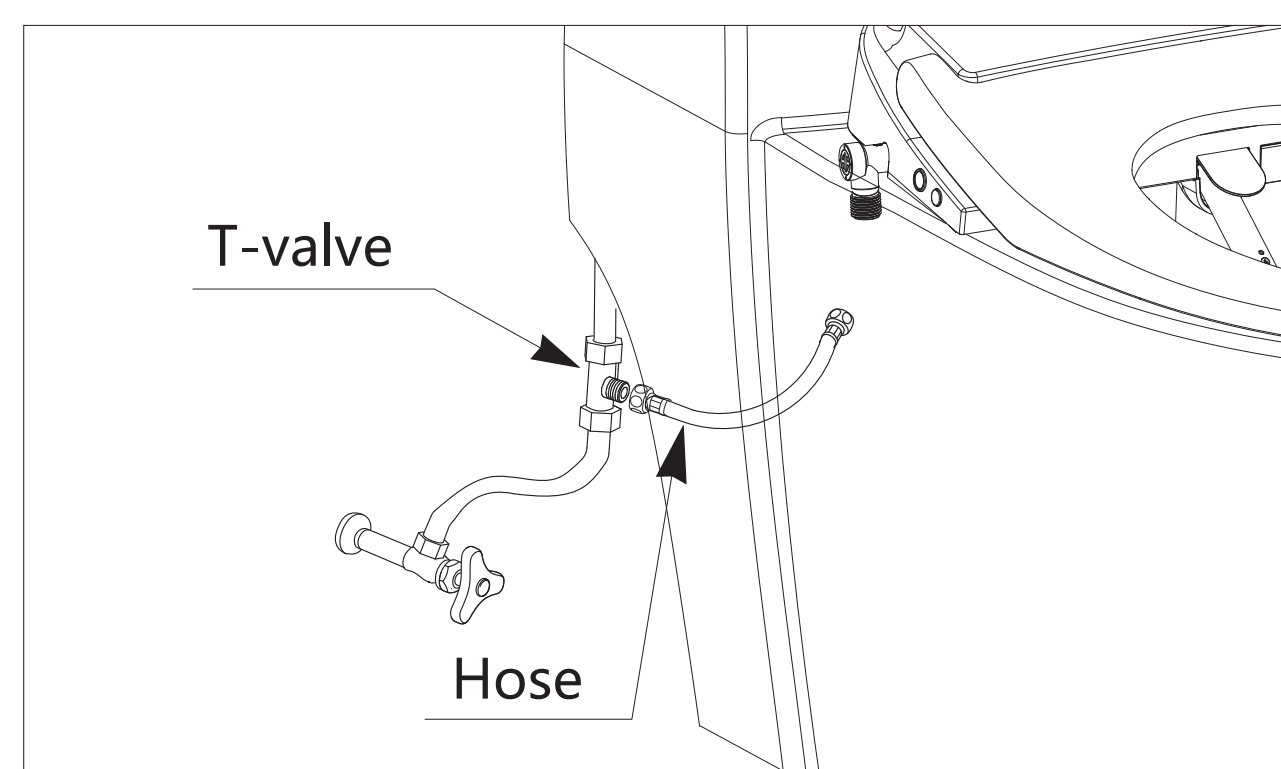

4. Connect the hose to bidet .

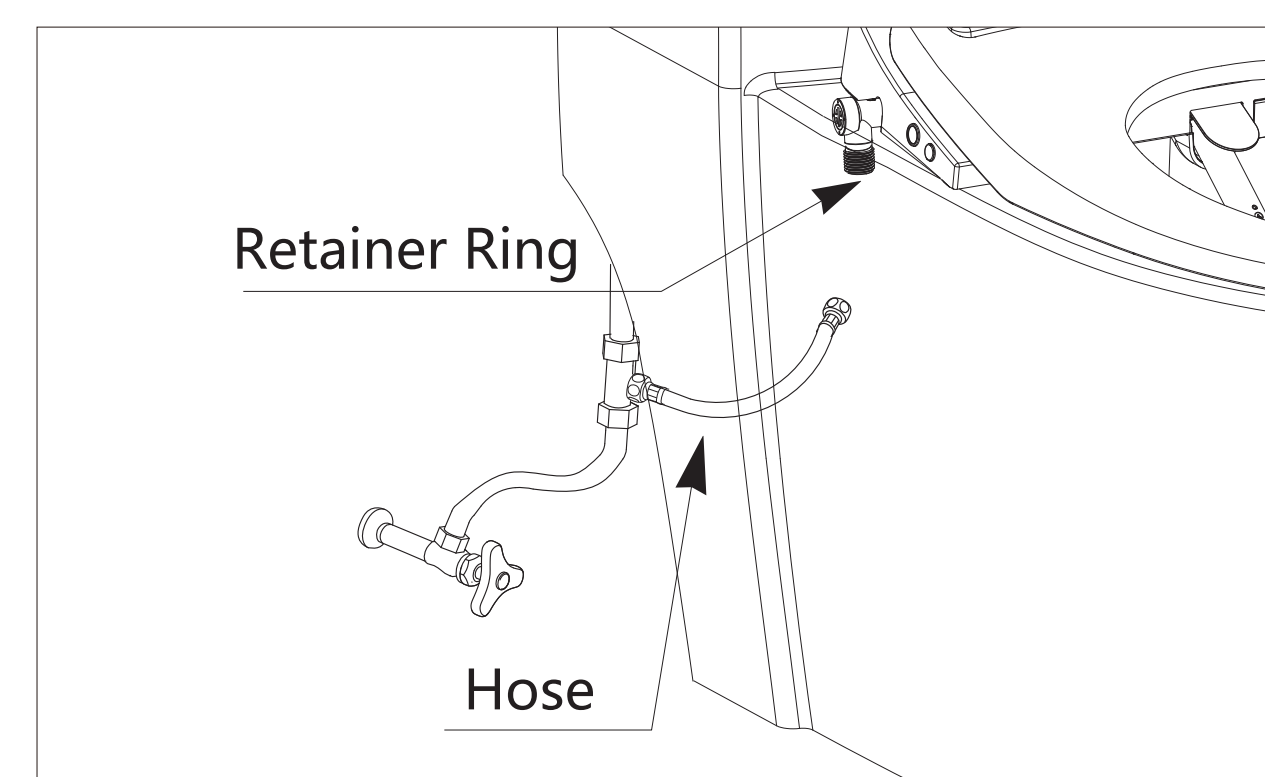

- Turn on the water

1. Turn the water back on by turning the knob on the supply angle valve counter-clockwise until the valve is fully open.
2. Check all connections carefully and make sure that there is no water leakage from any connection. If there is leaking from a connection, retighten the connection.

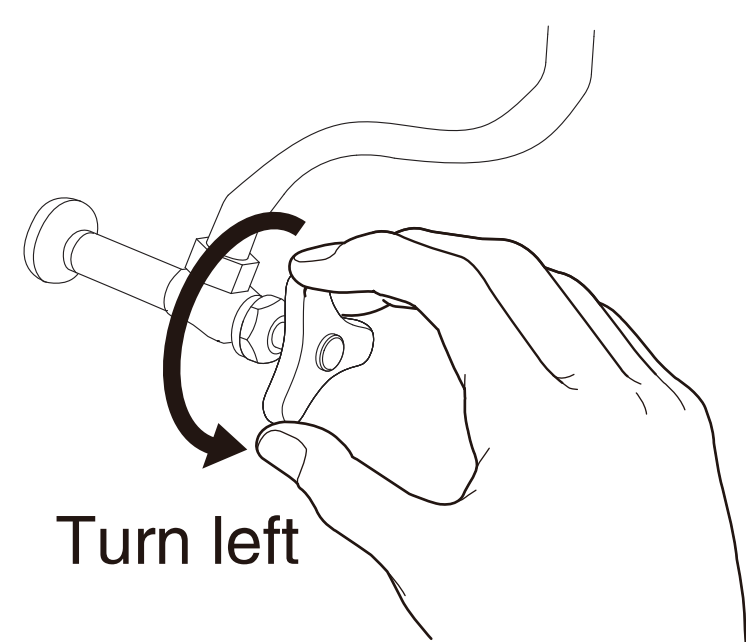

- Link the power

1. Insert the bidet plug into the outlet (120V).

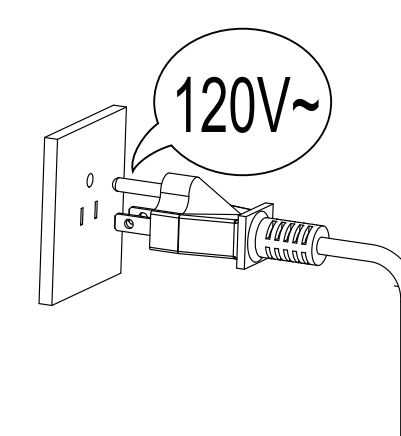

2. Confirm the power connection.
Press and hold down the power button for 0.5 seconds to turn on the bidet seat.

NOTE: Specialized tools may be necessary to install DeerValley smart toilet seat.

6. Functions

• Basic Functions

- ▶ Functions will only work when user is seated on the bidet seat.
- ▶ Dryer will automatically stop after 4 minutes.

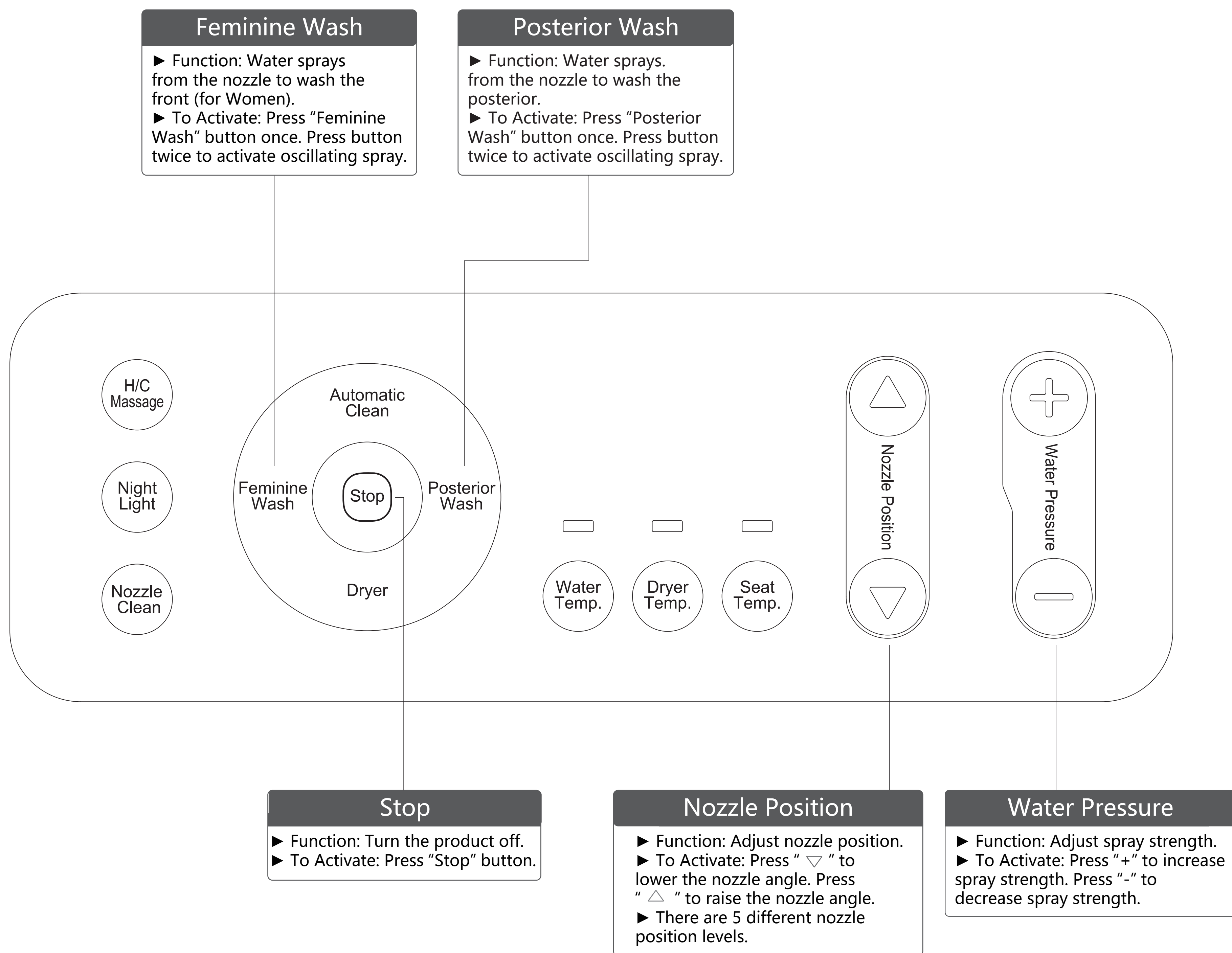

NOTE: Specialized tools may be necessary to install DeerValley smart toilet seat.

• Basic Functions (cont.)

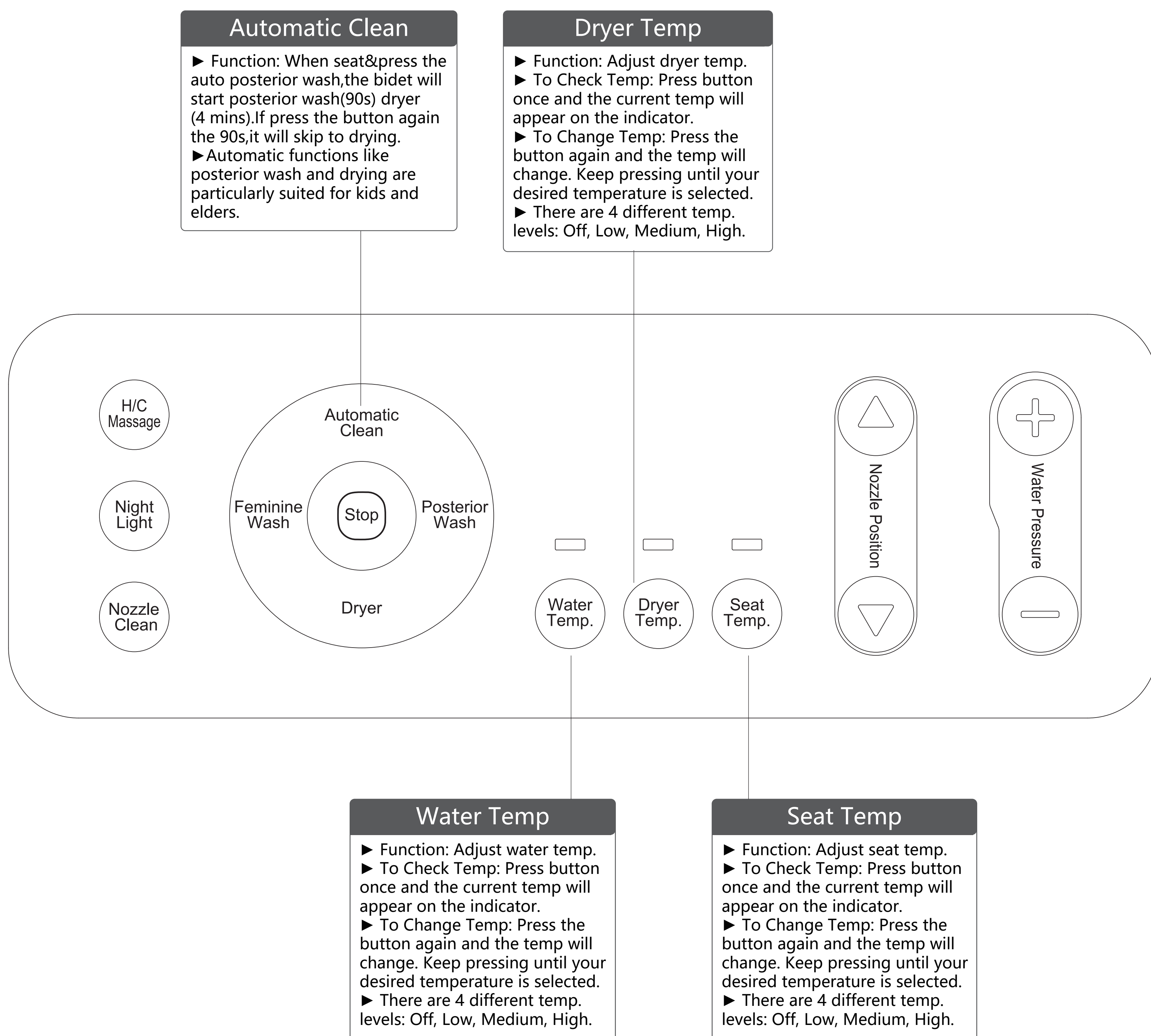

NOTE: Specialized tools may be necessary to install DeerValley smart toilet seat.

- Dryer

- ▶ Dryer will automatically stop after 4 minutes.

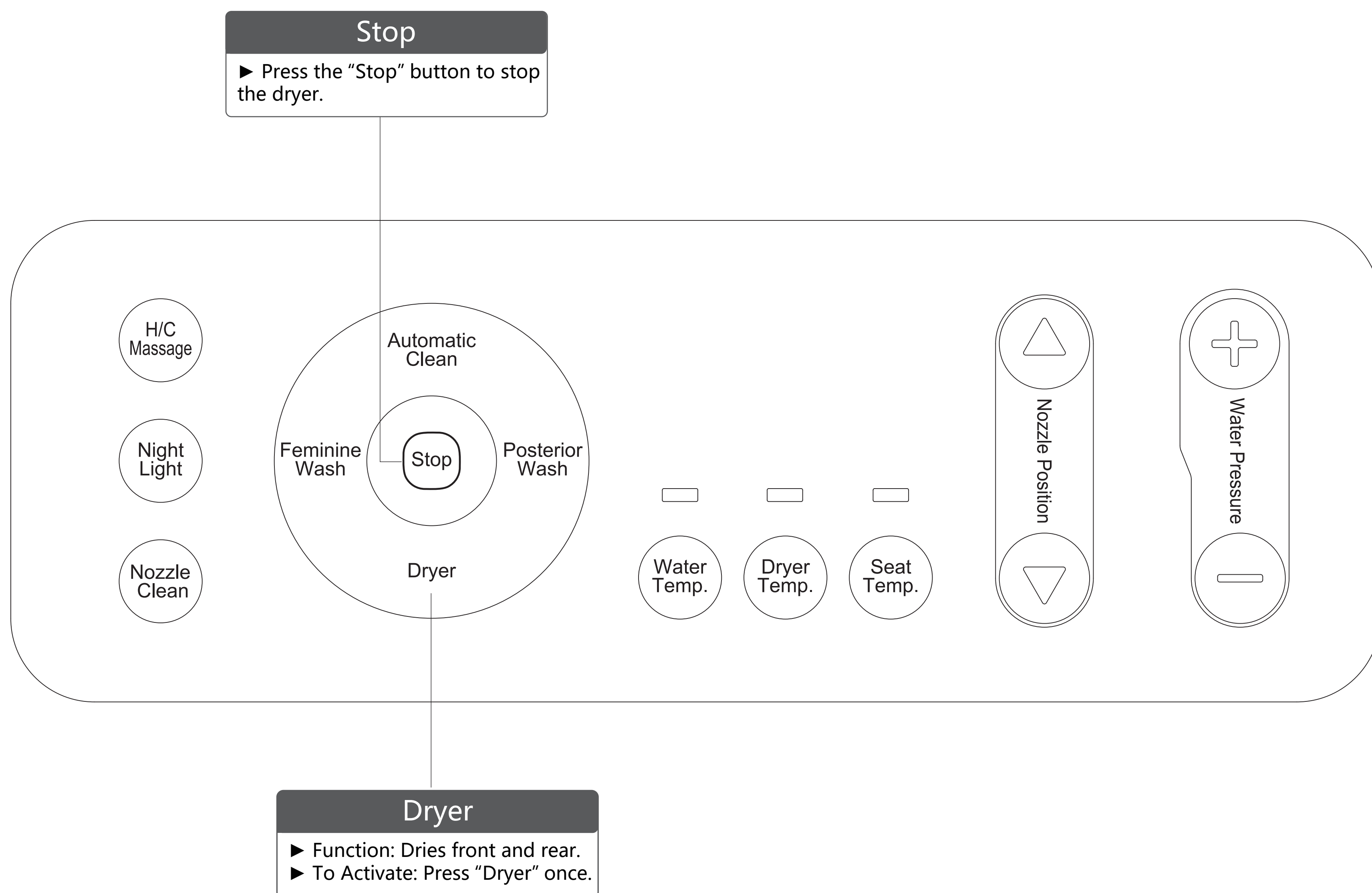

NOTE: Specialized tools may be necessary to install DeerValley smart toilet seat.

• Other Functions

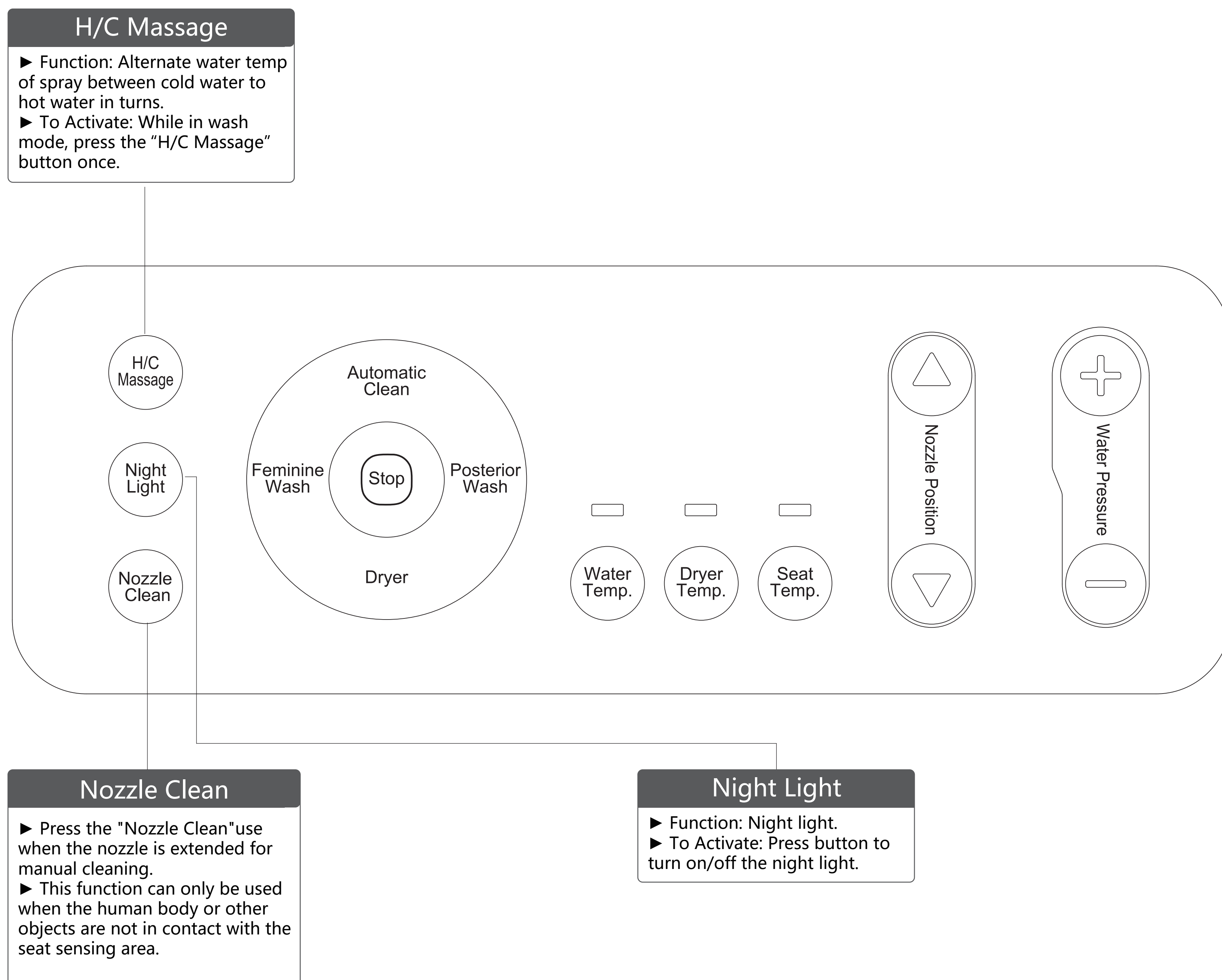

UV STERILIZATION

▶ The UV light will automatically turn on 10 seconds after the user rises from the seat and will remain active for 3 minutes. The UV sterilization indicator will turn red when UV sterilization is in progress and will turn off when complete.

NOTE: Specialized tools may be necessary to install DeerValley smart toilet seat.

7. Maintenance

• Maintenance

- ▶ Before maintenance, please unplug the power source and shut off the water supply.
- ▶ Regular maintenance is required to ensure that the product operates at optimum efficiency.

Maintenance of Lid, Seat, and Plastic Parts

- ▶ Wipe the lid, seat, and plastic parts with a wet soft cloth (water).
- ▶ Please wipe with water frequently or the product will become hard to clean later if the dirt and debris is not removed on time. Wiping with water can also help prevent static electricity from generating around the product, which can cause the product to accumulate dust and become dirty.
- ▶ For a deeper clean, the bidet can be removed from the toilet to access the surface beneath. To remove the bidet, press the catch plate button located on the right side of the bidet, then lift the bidet slightly to extract. (do not remove the bidet forcefully).

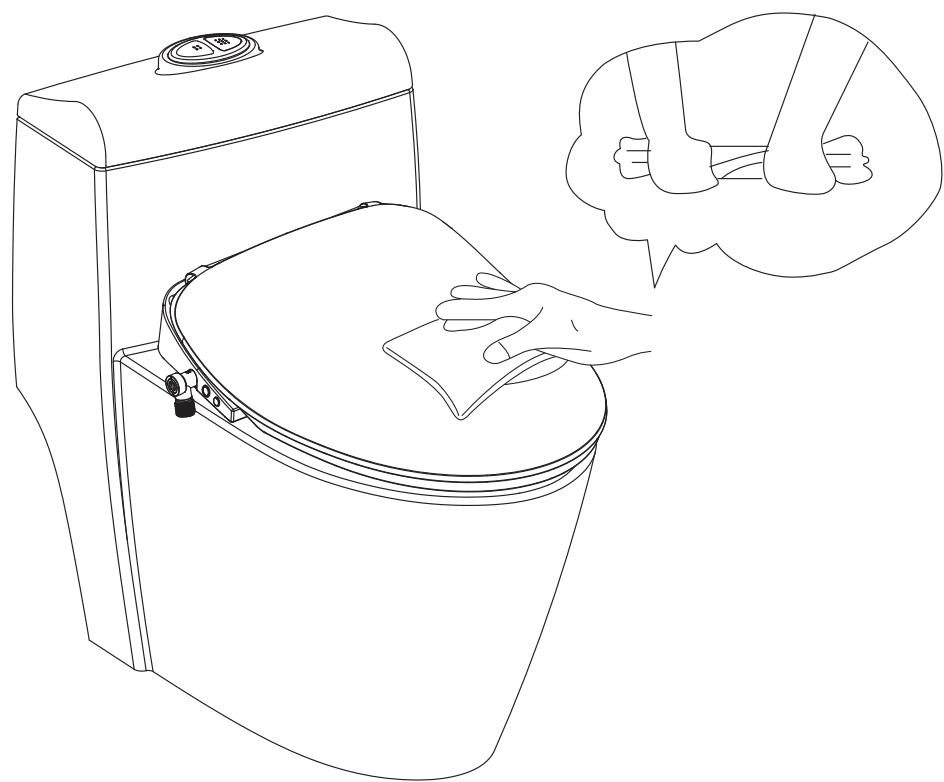

Maintenance of Steel Mesh Filter

- ▶ For your health, as well as optimal performance of the bidet, please clean or replace the filter regularly.
- ▶ If you notice that the water pressure is becoming weaker, please wash or replace the filter.
- ▶ Please make sure to turn off the water supply completely before removing the filter. Attach the new filter securely to avoid leakage.
- ▶ Turn the coin counterclockwise to open the filter and use a brush to clean.

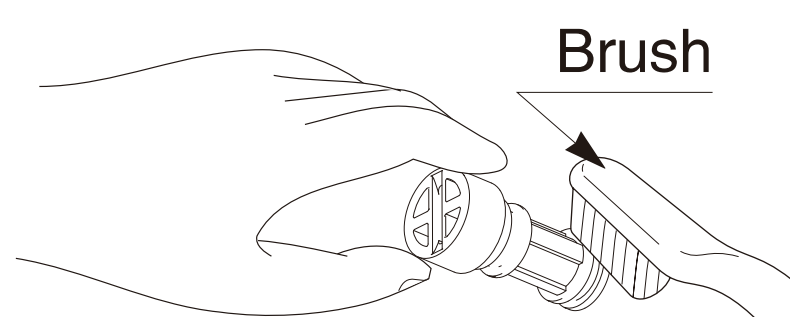

Recommended: Every 1-2 months

Maintenance of the Nozzle

- ▶ Press "Nozzle Clean" button without occupying the seat, the nozzle will extend and can be cleaned with a soft brush.
- ▶ Do not try to pull the nozzle out with force, or the nozzle may break.
- ▶ When the nozzle is clogged, it is recommended to replace it with a new one.

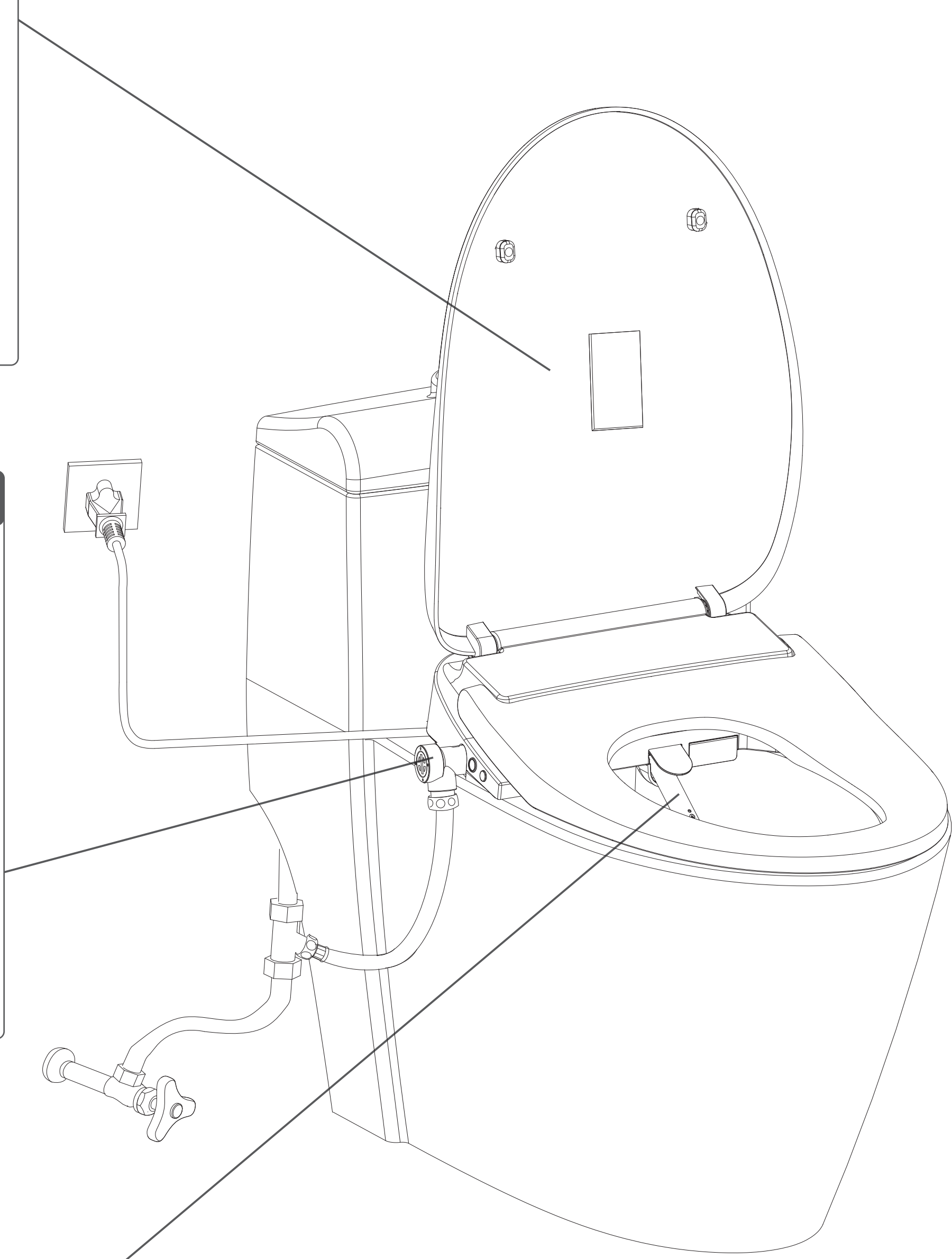
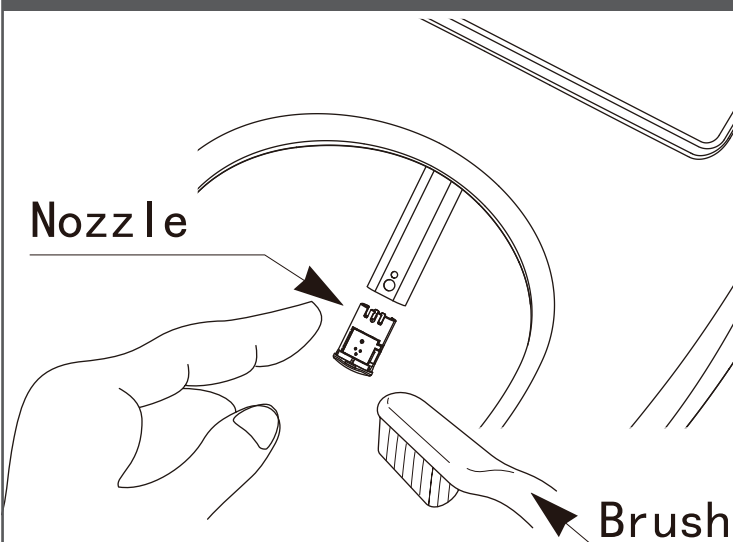

NOTE: Specialized tools may be necessary to install DeerValley smart toilet seat.

- Maintenance (cont.)

⚠ ATTENTION

Do not spray water or detergent on the bidet, remote control, or power cord.
▶ Otherwise, electric shock or fire may occur.

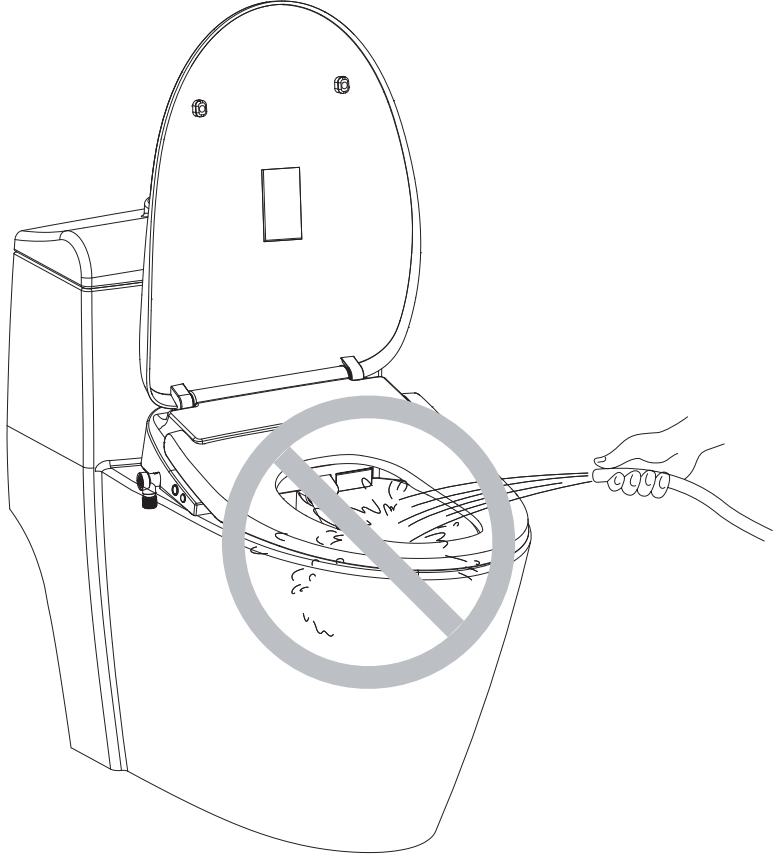

⚠ WARNING

While cleaning the plastic parts, do not use strong, acidic chemical cleaners (concentrated sulfuric acid, nitric acid, glacial acetic acid, carbon tetrachloride, chloroform, acetone, butyl ketone, benzene, toluene, phenol, cresol, methyl ether, methyl formamide, soybean oil, vinegar, 40% nitric acid, hydrochloric acid, 95% alcohol liquor, gasoline, kerosene, brake oil, etc.). Please only use neutral cleaners.
▶ Otherwise, the plastic may break, and cause body damage, electric shock, or fire.



NOTE: Specialized tools may be necessary to install DeerValley smart toilet seat.

8. Product Operation

• Troubleshooting

- If you experience any of the problems below, please follow the suggested solutions. If you continue to experience issues after trying the solutions, please consult with a qualified electrician or serviceman.

Power button		
Problem	Possible Causes	Possible Solutions
Toilet is not working	Blackout or loose socket	Check that power cord is plugged in
	Power off (Power indication light not on)	Press power button until indication light turns on
	Electric leakage	Unplug power cord, re-connect, then power on. If it is still not working, please unplug again and contact us

Wash functions		
Problem	Possible Causes	Possible Solutions
Water does not spray	No water in the supply	Wait for the water to restore to its normal levels
	Water supply is turned off	Turn water supply valve to turn on water
	Filter is stuck	Clean or replace filter
	Water hose is twisted	Stretch hose until it becomes untwisted
Water pressure is weak	Water level is set to LOW	Turn up water level to higher setting
	Filter is stuck	Clean or replace filter
Spray is off-center	Operational failure	Unplug device and re-plug in after 1 min
Water is not warm	Water temp. is set to LOW	Turn up water temp. level to higher setting
Water is leaking	Parts are loose or damaged	Contact us
Wash function does not activate	Check if the seat is lifted or sitting on something	Fix seat so it is flush on the bowl and remove any objects underneath
	Body sensor is broken	Contact us

NOTE: Specialized tools may be necessary to install DeerValley smart toilet seat.

- Troubleshooting (cont.)

Dryer		
Problem	Possible Causes	Possible Solutions
Dryer is not warm	Dryer temp. is set to OFF	Turn up dryer temp. to higher setting
	Dryer is broken	Contact us
Dryer stops during use	Dryer will stop every 4 mins	Enable dryer again

Heated Seat		
Problem	Possible Causes	Possible Solutions
Seat temp. not warm	Seat temp. is set to OFF	Turn up seat temp. to higher setting
	Power-saving mode on	Turn off power-saving mode

Other		
Problem	Possible Causes	Possible Solutions
Lid or seat closes fast	Damping is broken	Contact us
Functions work in turns nonstop	QA testing model activated	Unplug device and re-plug in after 1 min

NOTE: Specialized tools may be necessary to install DeerValley smart toilet seat.

- Specifications

Model Number		F1W535
Rated Voltage		AC 120V, 60Hz
Rated Power		1050W
Environmental Temp		41°F-104°F
Water Inlet Environment		41°F-104°F
The range of water inlet pressure	Minimum necessary water pressure	0.08MPa, and also make sure the water flow is above 2.3L/10s
	Maximum water pressure	0.8MPa (in a static condition)
Flushing	Way for heating	Transient heating
	Temp pf warm water	Off/about 93.2°F-102.2°F
The length of power line		47.24in
The size of product		20.4in x 16.14inx 5.24in

NOTE: Specialized tools may be necessary to install DeerValley smart toilet seat.

• Model Comparison Chart

Category	Function	Model	F1W535
Cleaning	Unlimited wash		●
	Rear wash		●
	Front wash		●
	Aerated wash		●
	Auto wash		●
	Oscillating wash		●
	H/C massage		●
	Adjustable water pressure		●
	Adjustable water temperature		●
	Adjustable nozzle position		●
	Detachable nozzle		●
	Nozzle self-cleaning		●
	Cleaning Nozzle		●
Power Saving and Convenient	Heated seat		●
	Warm dryer		●
	Soft close		●
	Adjustable seat temperature		●
	Adjustable dryer temperature		●
	Night light		●
	Instant heating		●
Safe and Environmental Protection	Seat sensor		●
	Memory mode		●
	Auto-start		●
	SUS filter		●
	Air isolation		●
	UV Sterilization		●
	Anti-bacterial seat		●
Eight protections		●	

Notice: ● represents that the product have this function.

NOTE: Specialized tools may be necessary to install DeerValley smart toilet seat.

LIMITED WARRANTY COVERAGE

1 YEAR LIMITED WARRANTY

DeerValley products are made with quality materials and excellent craftsmanship to provide the customers a long-lasting product. In the case of any defects in materials or craftsmanship under regular use were inspected in the first one year of delivery, DeerValley will provide replacement parts at no charge, or at its option, replace any product or part of the product that is deemed defective, under normal installation, use, service and maintenance. This warranty applies only to the original purchaser. Proof of purchase will be required in the case of a claim. **SCRATCHES ARE NOT COVERED UNDER WARRANTY.**

The manufacturer warrants this product to be free of manufacture defects during the above mentioned warranty time. Please keep a copy of the original invoice as proof of purchase.

DeerValley will, as its option, (1) repair or replace the defective part(s) or product(s) at no charge; (2) issue a refund of the original purchase price of the product(s) (Valid within 30 days from the date of delivery); or (3) issue a credit to be applied toward the purchase of a new DeerValley product shipping/delivery charges may apply and are in DeerValley sole discretion.

DeerValley recommends the installations to be made by a licensed, professional plumber. DeerValley will not be held responsible for any damage or product failure due to improper installation, misuse, or failure to use a licensed professional. DeerValley is not responsible for any removal or installation cost.

This limited warranty shall not apply to goods which have been subject to accident, negligence, improper installation, product abuse, product misuse, or use of cleaners containing abrasives, alcohol or other organic solvents, whether performed by a contractor, service company, or yourself, are excluded from this warranty.

DeerValley responsibility under this limited warranty is limited to only to replacement parts and no other costs. DeerValley will not be responsible for labor charges and/or damage incurred by installation, repair or replacement, nor for any indirect incidental or consequential damages, losses, injury or costs of any nature relating to this product Except as provided by law, this limited warranty is in lieu of and excludes all other warranties, conditions, and guarantees, whether expressed or implied, statutory or otherwise, including without restriction those merchantability of fitness for use.

RESPONSIBILITIES OF OTHERS

Inspecting the unit prior to installation is the responsibility of the installer or building contractor who acts on behalf of the user. They are responsible for ensuring the unit is free of defect or damage.

Notices are placed on and in the unit and on the shipping carton advising the installer of this responsibility.

In the event of a problem, the unit must not be installed. DeerValley is not responsible for failures or damage that could have been discovered, repaired, or avoided by proper inspection and testing prior to installation.

Damage occurring in transit is the responsibility of the carrier. The user or installer **MUST** open the crate and inspect the unit for damage when it is delivered. If damage is discovered, it must be reported immediately to the seller and the carrier in writing, and an inspection requested. Failure of the carrier to respond should be reported to the seller and the carrier. Your freight claims should be filed promptly thereafter.

LIMITATIONS AND EXCLUSIONS

This warranty does not cover instances of negligence, misuse, abuse, improper installation, carelessness, accident, hard water or mineral deposits, exposure to corrosive materials, misapplication, damages caused by improper maintenance, alteration of the product, or failure to follow care or installation instructions enclosed with your product. The warranty becomes invalid if the DeerValley product undergoes any alterations or if attempts are made to carry out repairs using unauthorized accessories or parts from DeerValley.

DeerValley will not be liable for loss of use of the DeerValley products, inconvenience, or any other incidental or consequential costs, expense or damages. Please note that some states do not allow the exclusion or limitation of incidental damages.

DISCLAIMER

Except as expressly provided, there shall be no warranty or obligation, express or implied, oral or statutory. No dealer or other person has the authority to make any warranties or representations concerning DeerValley or its products. In no event shall DeerValley be held responsible for any such warranties or representations.

WARRANTY SERVICE

NOTE: When requesting warranty, be sure to have the following:

- Copy of original invoice
- Date of installation
- Description and pictures of defect
- Model number or description of model

To obtain warranty service and replacement part, please contact DeerValley Customer Service. DeerValley will determine whether to repair or replace your product, issue a refund, or issue a credit.