

VEVOR[®]

TOUGH TOOLS, HALF PRICE

Technical Support and E-Warranty Certificate www.vevor.com/support

TUNNEL GREENHOUSE

USER MANUAL

We continue to be committed to provide you tools with competitive price. "Save Half", "Half Price" or any other similar expressions used by us only represents an estimate of savings you might benefit from buying certain tools with us compared to the major top brands and does not necessarily mean to cover all categories of tools offered by us. You are kindly reminded to verify carefully when you are placing an order with us if you are actually saving half in comparison with the top major brands.

VEVOR[®]

TOUGH TOOLS, HALF PRICE

TUNNEL GREENHOUSE

2×3×2M(3)W / 2×3×2M(3)G / 2×3.5×2M(3)G

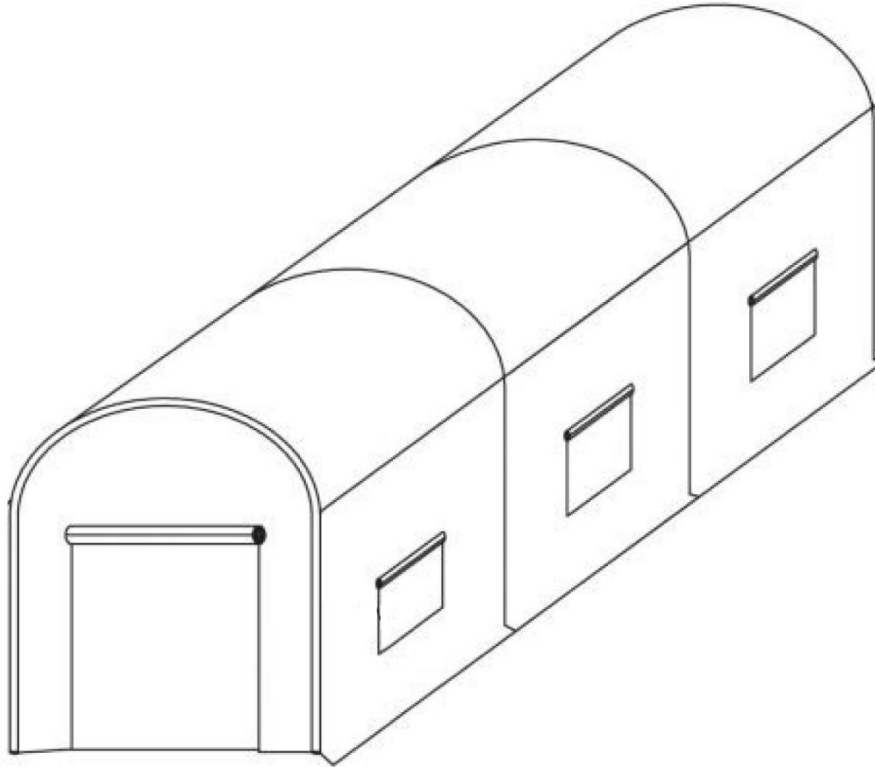

NEED HELP? CONTACT US!

Have product questions? Need technical support? Please feel free to contact us:

Technical Support and E-Warranty Certificate
www.vevor.com/support

This is the original instruction, please read all manual instructions carefully before operating. VEVOR reserves a clear interpretation of our user manual. The appearance of the product shall be subject to the product you received. Please forgive us that we won't inform you again if there are any technology or software updates on our product.

Safety precautions







WARNING:



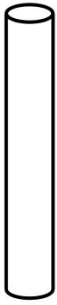







Read this instructions before using this product. Failure to do so can result in serious injury. the basic precautions should always be followed,including the following:







1. The tunnel greenhouse may not be used or stored in hazardous areas. It is not allowed to use the appliance in hazardous locations.
2. The tunnel greenhouse must be checked to ensure that it is in proper working order and is operating safely prior to use. Otherwise,the appliance must not be used.
3. Use as intended only. Corrosive substances should not be stored in tunnel greenhouses
4. The operator must use the tunnel greenhouse properly. He must consider the local conditions and must pay attention to third parties,in particular children,when working with the tunnel greenhouse.
5. This tunnel greenhouse is not intended for use by persons (including children) with reduced physical,sensory or mental abilities or lacking experience and/or knowledge,unless they are supervised by a person responsible for their safety or are instructed by these persons on the use of the device. Children should be supervised,to ensure that they do not play with the tunnel greenhouse.

SAVE THESE INSTRUCTIONS

Product List

1	2	3	4	5	6
					
4x	4x	5x	10x	2x	2x

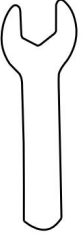
7	8	9	10	11	12	13
			  M6*25	  M6*30	  M6*50	  M6*55
2x	2x	16x	4x	8x	12x	8x

14	15	16	17	18	19
					
4x	4x	10x	1x	1x	1x

Model	2×3×2M(3)W	2×3×2M(3)G	2×3.5×2M(3)G
Product Size	10x7x7ft (292*196*196cm)		12x7x7ft (345*196*196cm)
Tarpaulin Color	White	Green	Green

WARNING

Covering the roof carefully, puts all places in the right position.

As much as possible as not make the frame structure of the greenhouse out of the shape.

Do not use it in bad weather conditions, such as a rainstorm, hailstone, heavy snow, and heavy wind.

Note:

- 1. This product needs two people to cooperate with the assembly.**
- 2. Due to the large number of screws, it is recommended to use power tools.**
- 3. Do not lock the screws directly during the installation process, and lock all the screws after all the shelves are set up.**
- 4. Take out all the accessories and place them according to the list above for installation.**

Assembly Instruction

Take out all the accessories and place them according to the list above for installation.

Install the brackets on left sides.

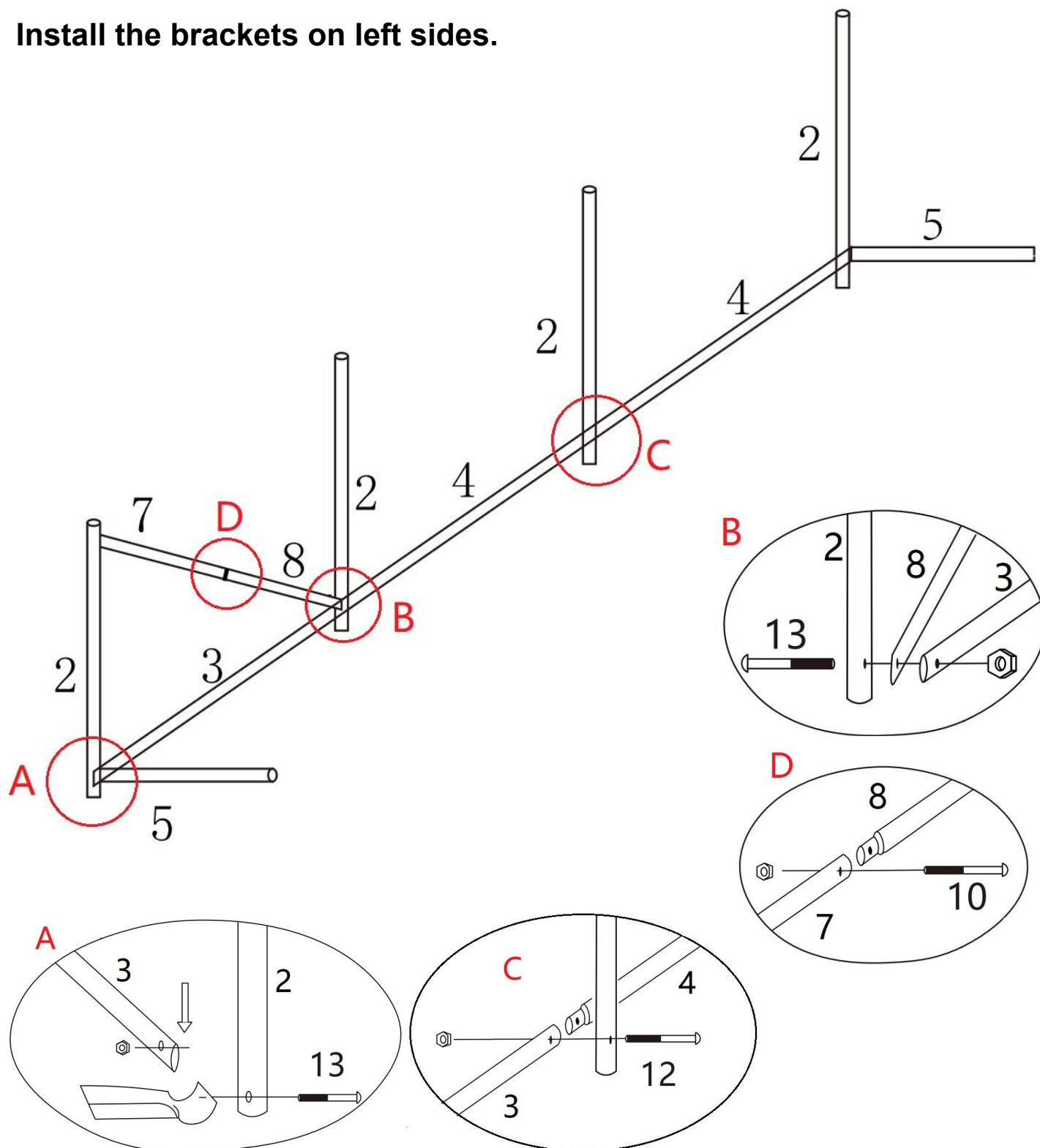

1. Please place the parts according to the above picture;
2. Lock the pole with screws(13*3pcs)(12*1pcs)(10*1pcs);
3. Do not lock it first, so as to facilitate the installation later;

Install the brackets on right sides.

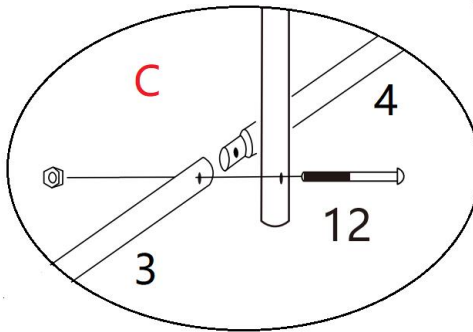
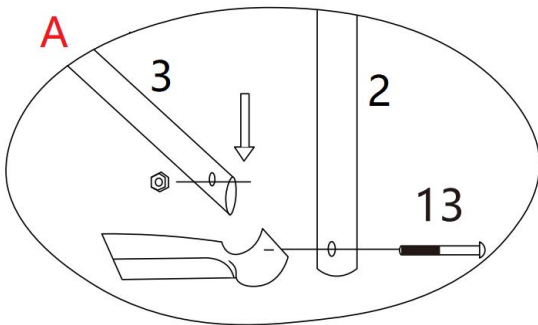
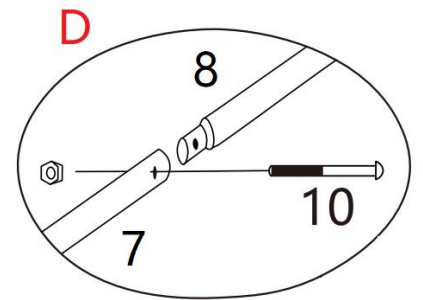
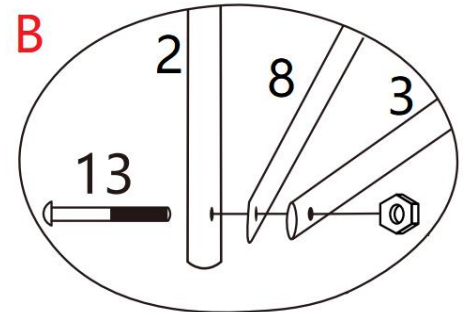
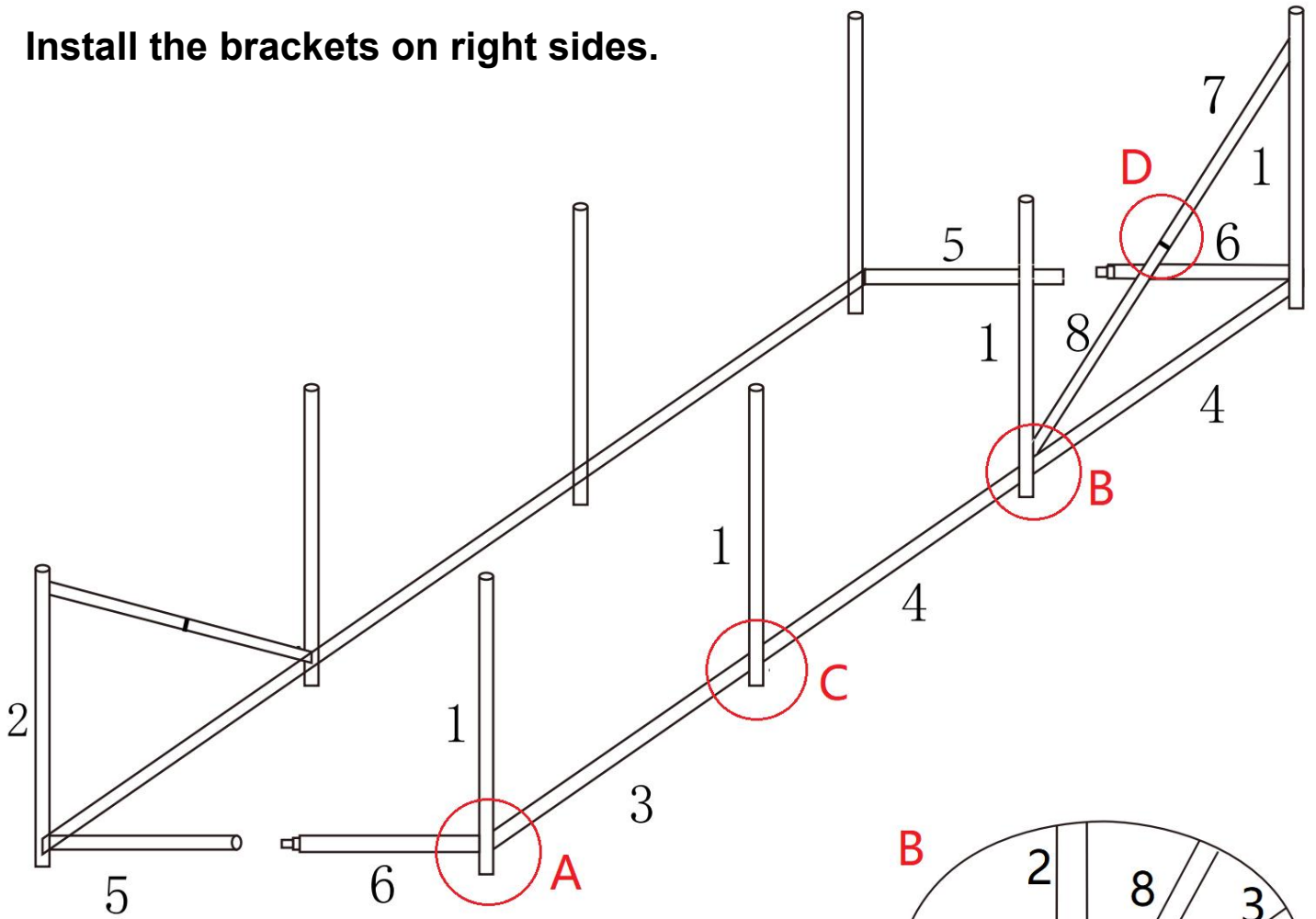

1. Please place the parts according to the above picture;
2. Lock the pole with screws(13*3pcs)(12*1pcs)(10*1pcs);
3. Do not lock it first, so as to facilitate the installation later;

Install the bracket at the top.

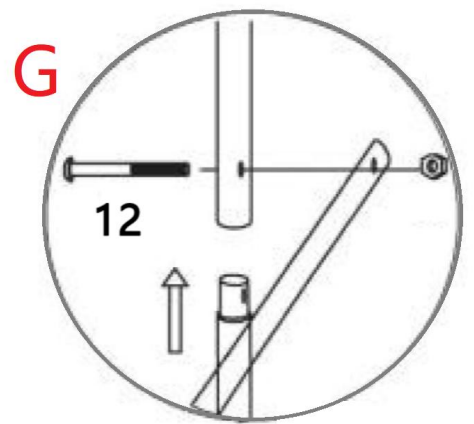
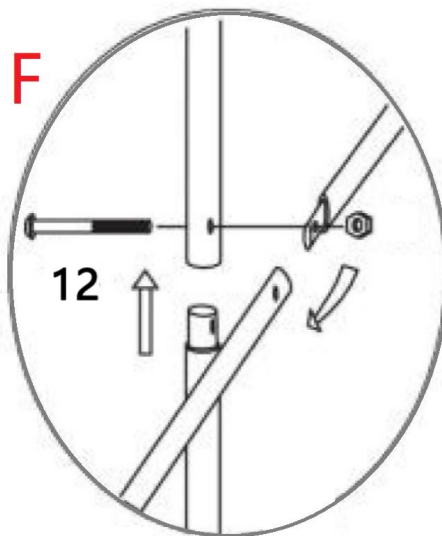
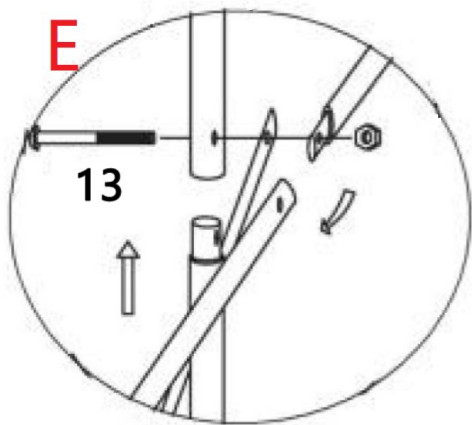
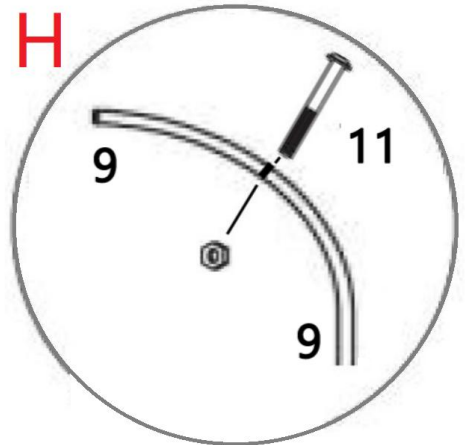
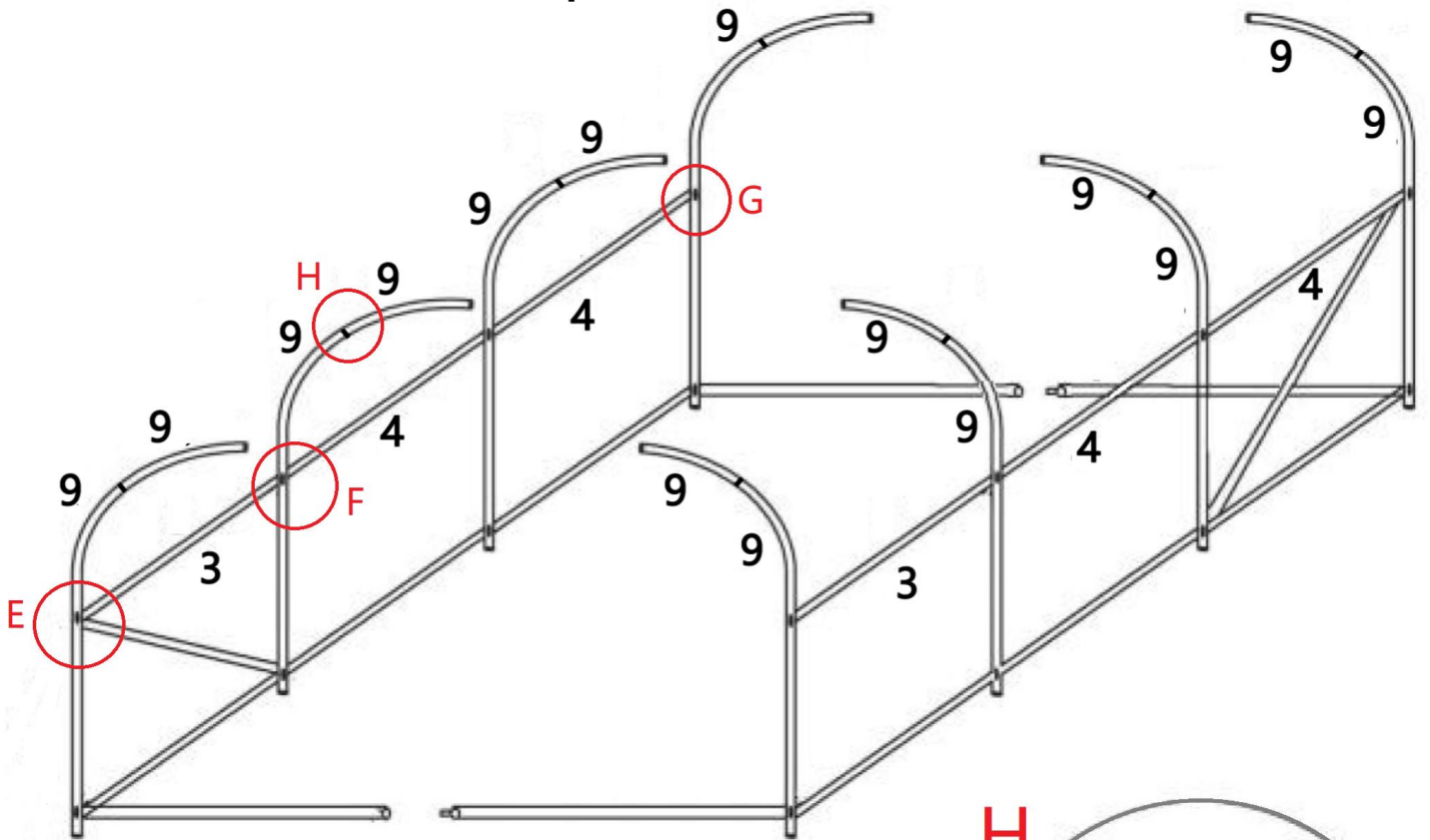

1. Please place the parts according to the above picture ;
2. Lock the pole with screws(13*2pcs;12*6pcs;11*8pcs;);
3. Do not lock it first, so as to facilitate the installation later;

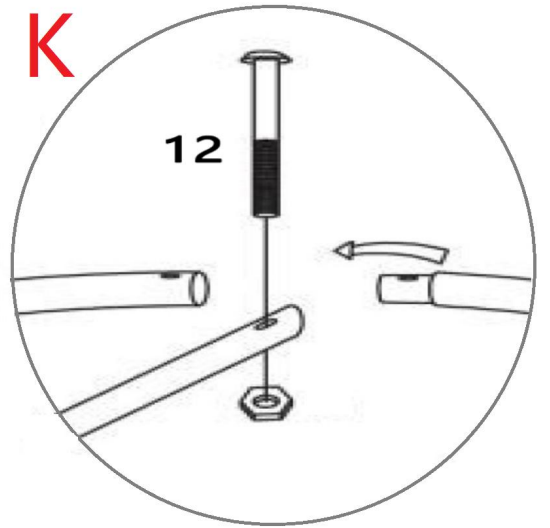
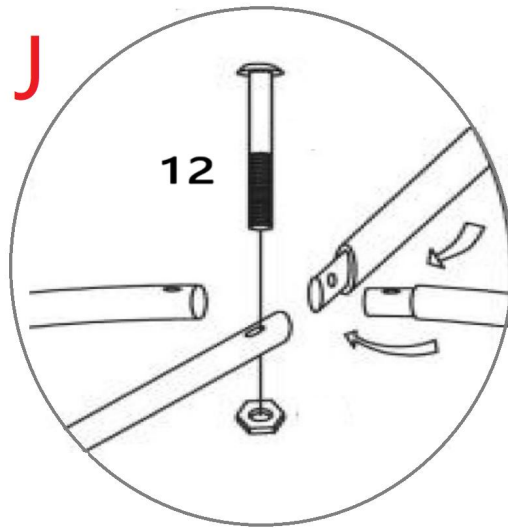

Assemble the assembled left and right brackets and the top brackets.

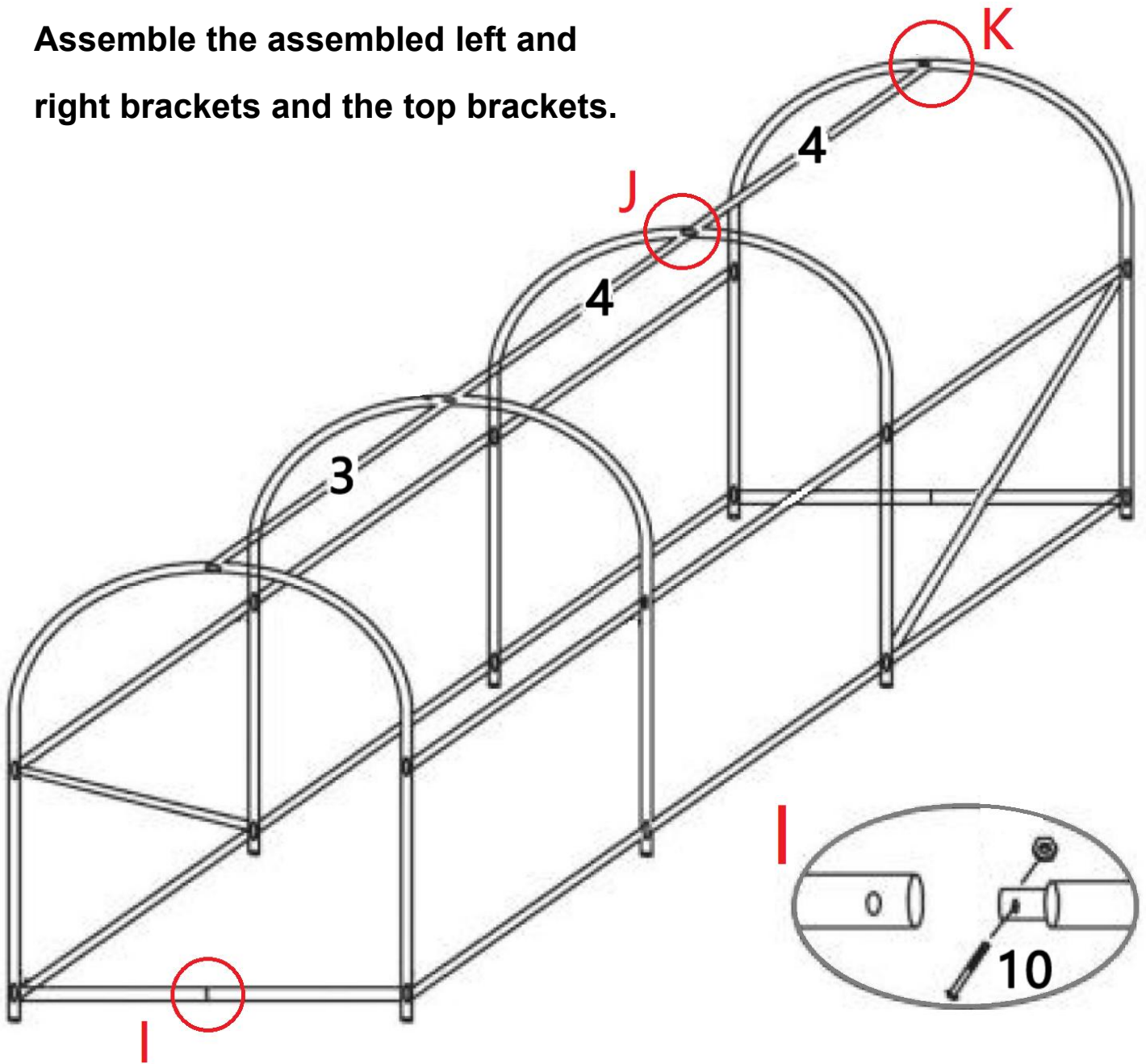

1. Please place the parts according to the above picture ;
2. Lock the pole with screws(12*4pcs;10*2pcs;);
3. Do not lock it first, so as to facilitate the installation later;

Tighten all bolts and nuts in full.

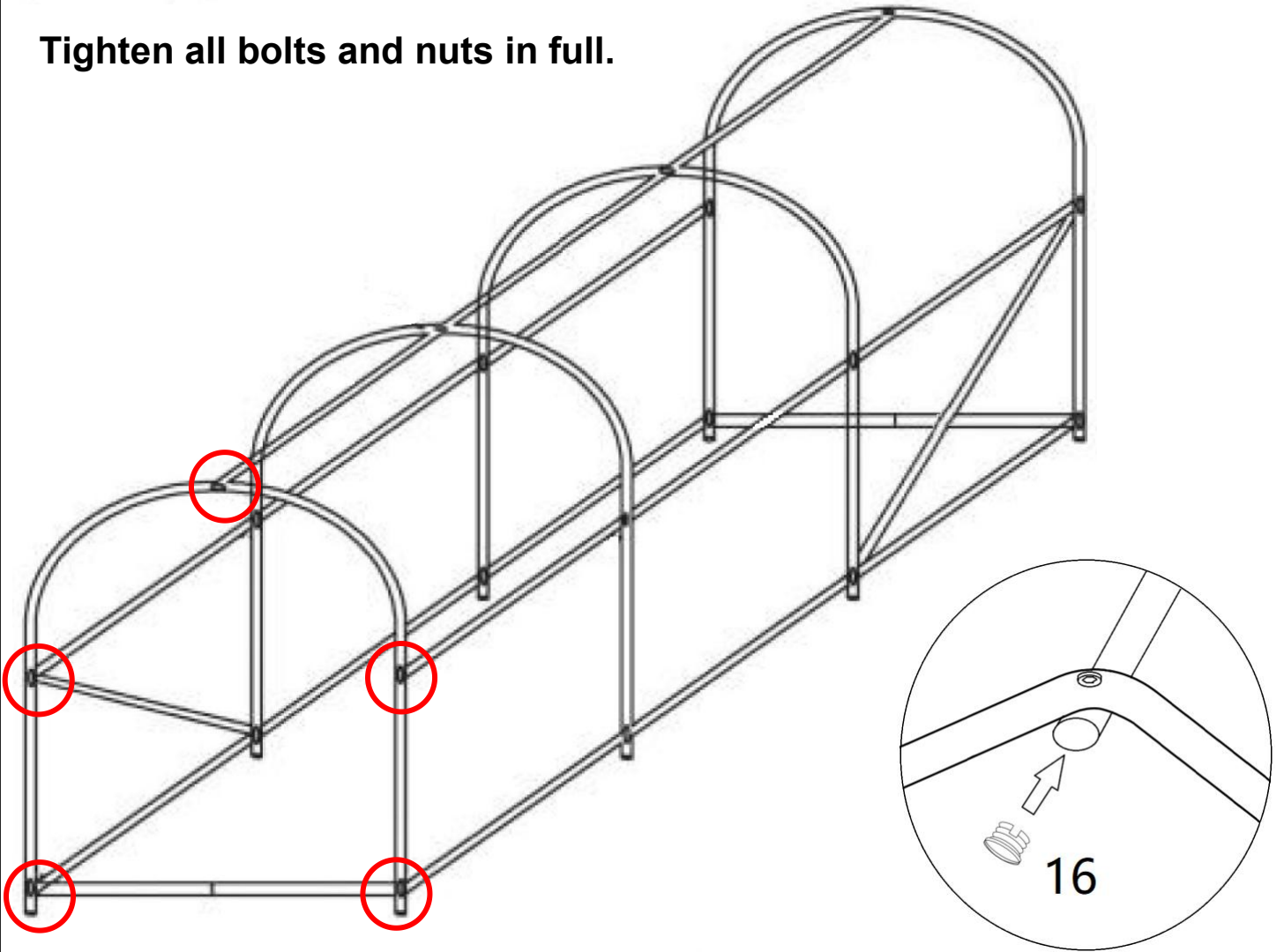

Use plastic stoppers(16*10pcs)
to plug the nozzles on both sides.

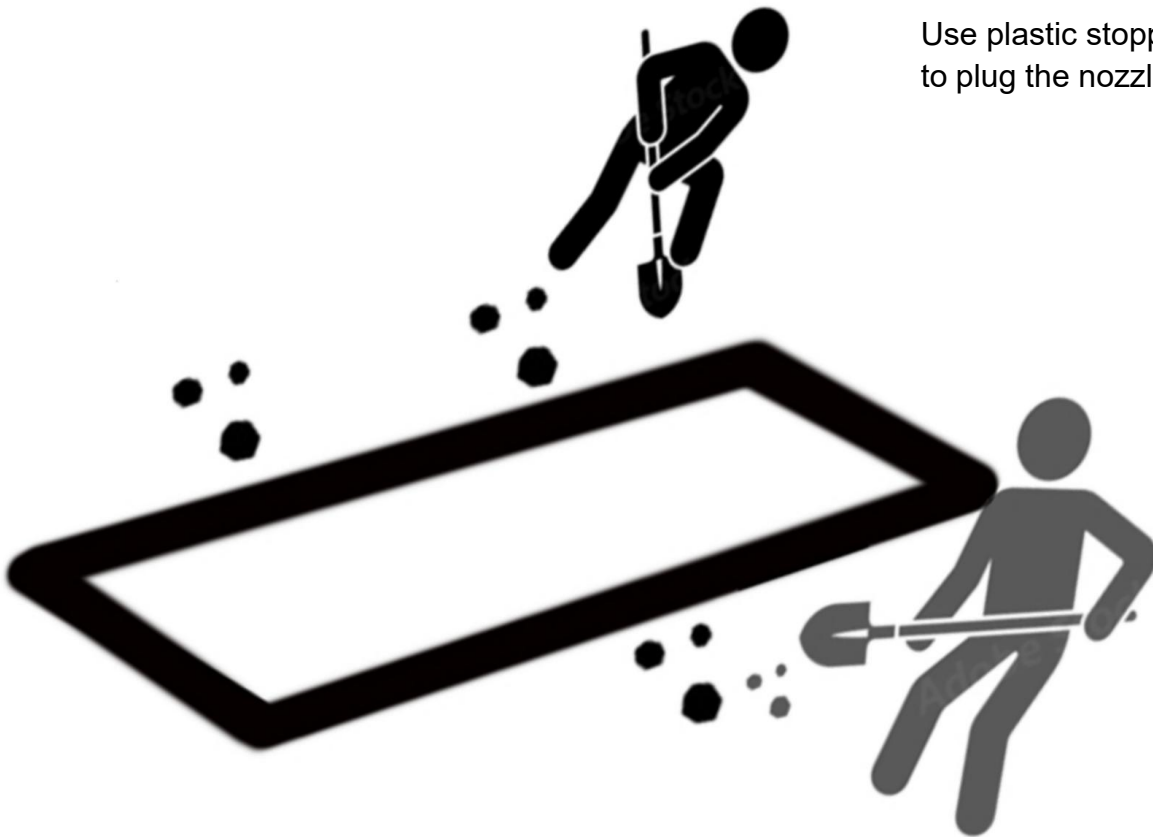

For maximum stability of your polytunnel, we recommend digging a 20cm width trench around the base of the polytunnel and back.

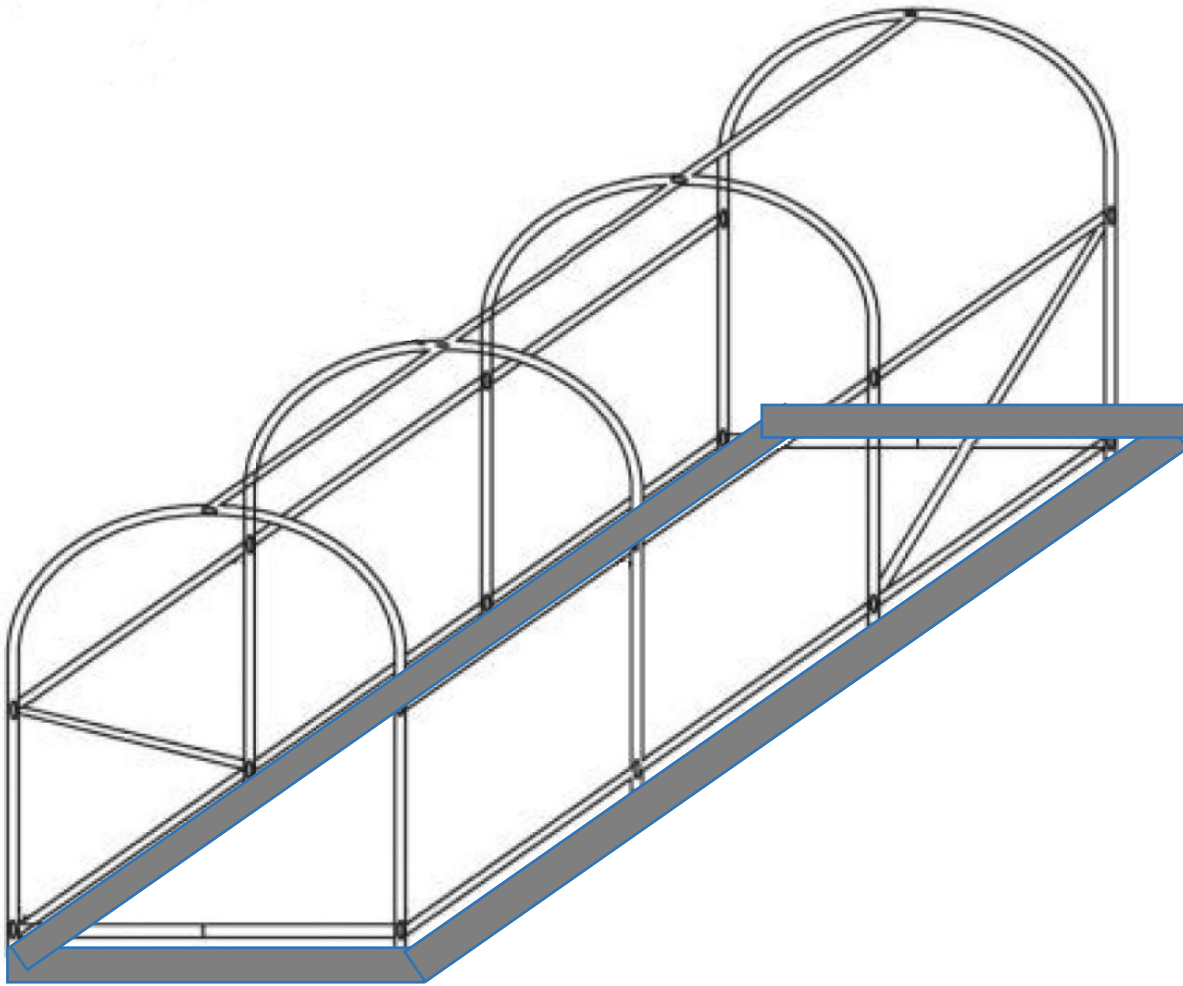

Place the assembled bracket in its entirety into the pre-dug pit foundation.

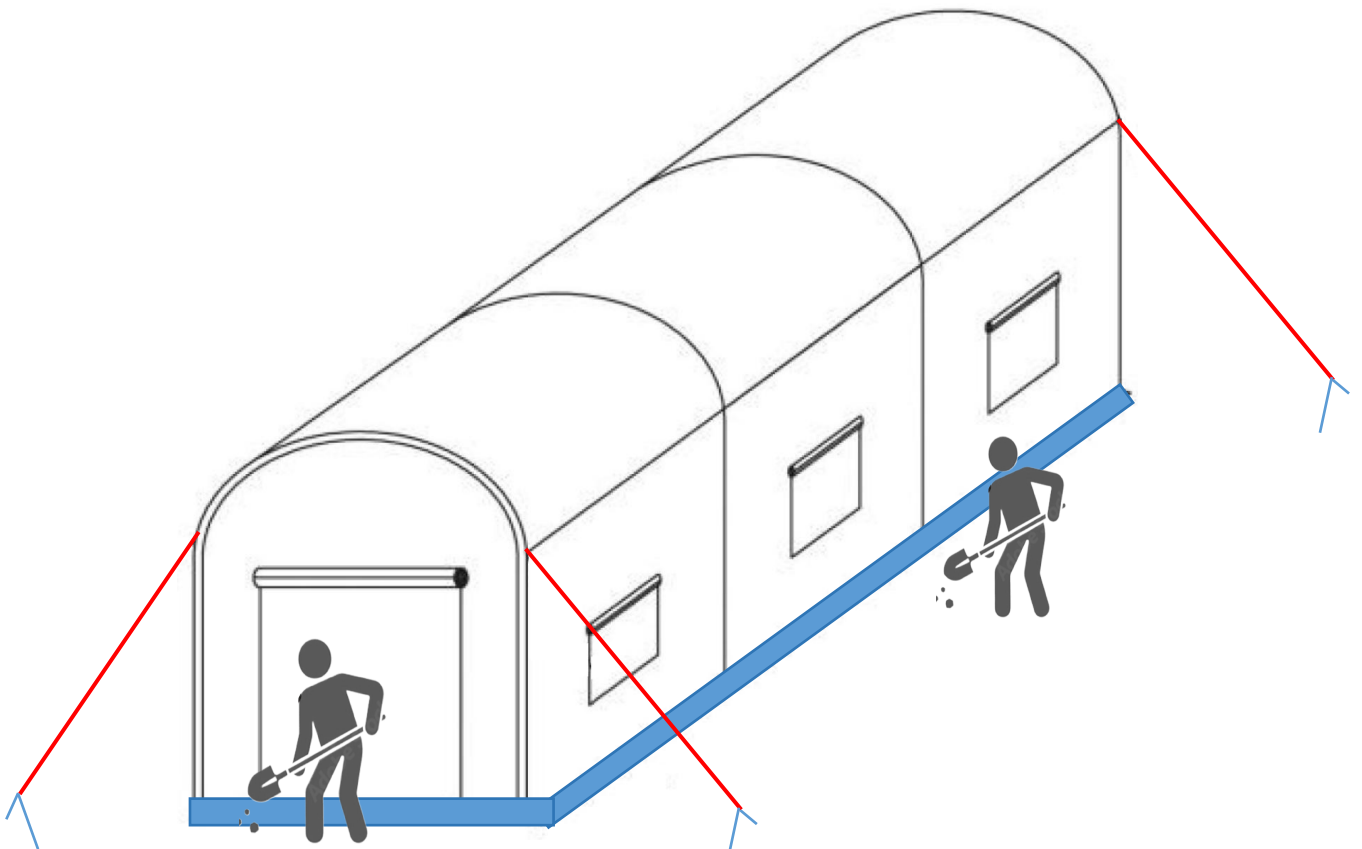

Cover the edges of the tarpaulin(19) with dirt and compact, to reinforce the stability of it. Drill the spiral nail(15*4pcs) into the soil first, and then use a rope(14*4pcs) to tighten and tie tunnel greenhouse and the spiral nail tightly.

Manufacturer: Shanghaimuxinmuyeyouxiangongsi

Address: Shuangchenglu 803nong11hao1602A-1609shi, baoshanqu, shanghai
200000 CN.

EC REP: E-CrossStu GmbH.

Mainzer Landstr.69, 60329 Frankfurt am Main.

UK REP: YH CONSULTING LIMITED.

C/O YH Consulting Limited Office 147, Centurion House, London Road,
Staines-upon-Thames, Surrey, TW18 4AX

Imported to AUS: SIHAO PTY LTD.

1 ROKEVA STREETEASTWOOD NSW 2122 Australia

Imported to USA: Sanven Technology Ltd.

Suite 250, 9166 Anaheim Place, Rancho Cucamonga, CA 91730

VEVOR[®]

TOUGH TOOLS, HALF PRICE

Technical Support and E-Warranty Certificate

www.vevor.com/support