

# LIGHTED MEDICINE CABINET WITH MIRROR

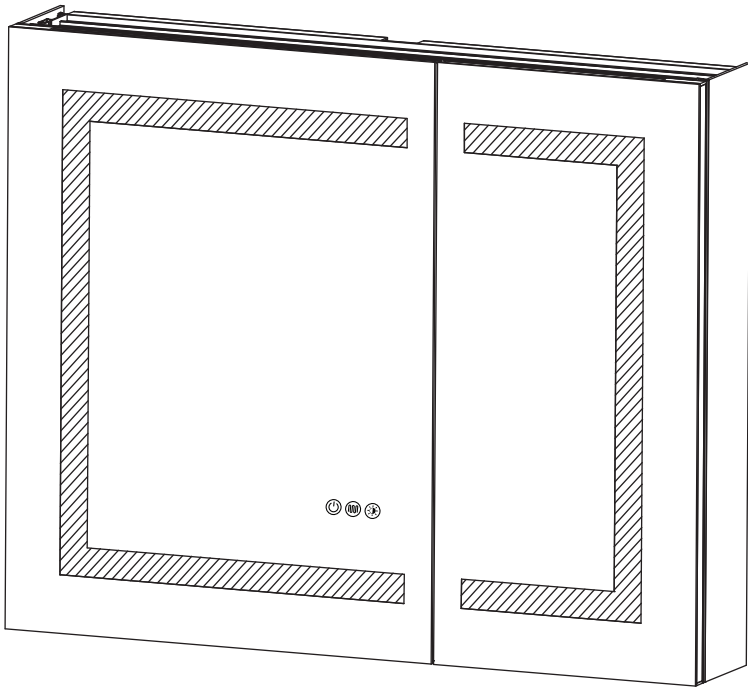

Instruction Manual

If you have any questions, please contact our Customer Service:

✉ Email: [support@woodsam.com](mailto:support@woodsam.com)

To keep the product in good condition, we recommend correct usage and regular cleaning.

---

## How to use

- Please use this product within the safe voltage range of 100V-120V.
- Please wrap the wires with electrical tape to prevent leakage.
- Avoid hitting the mirror glass with hard or sharp objects.

## How to clean

- Use a soft, non-abrasive cloth to clean the mirror. Avoid using rough or abrasive materials that may damage the surface.
  - Do not use any powerful cleaner that may irritate or damage the mirror surface.
- 

## LED Mirror Cabinet Installation Manual

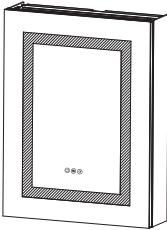

20"X26"X5.1"

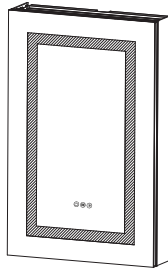

20"X32"X5.1"

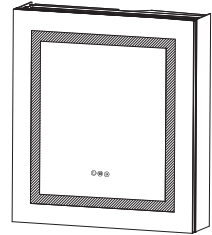

24"X30"X5.1"

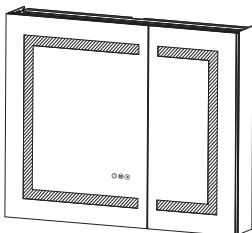



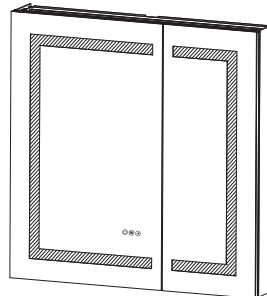



30"X32"X5.1"

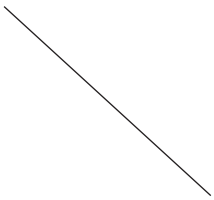
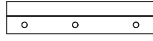
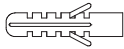

32"X36"X5.1"

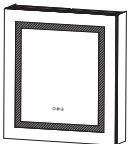
# PACKING LIST

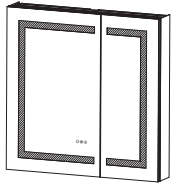
	 Mounting Brackets	 Expansion Tube	 Self-tapping Screw	 Glove
 20"x26"x5.1"	2	8	8	1
 20"x32"x5.1"	2	8	8	1
 24"x30"x5.1"	2	8	8	1
 30"x32"x5.1"	2	8	8	1
 32"x36"x5.1"	2	8	8	1

To ensure the best experience, please read and follow the instructions below carefully before assembling and installing the product.

## 1. Important Safety Instructions:

- It is strongly recommended that two or more adults perform the assembly to ensure proper installation.
- It is strongly recommended that a qualified technician or electrician connect the wires to the electrical junction box.
- Disconnect the power supply before installing, adding, or replacing any components.
- Make sure the fixed location can support the weight of the entire unit (such as a solid stone or brick wall).
- To prevent injury, the mirror must be installed according to the instructions provided.

## 2. Pre-Assembly:

- Inspect the product immediately upon receipt for shipping damage or missing parts.
- The product voltage should be between 100V and 120V. If the voltage is over 120V, use a transformer.
- You can connect the wires directly to the junction box or plug.

## 3. After Installation

- Please check and make sure the mirror is functioning properly.

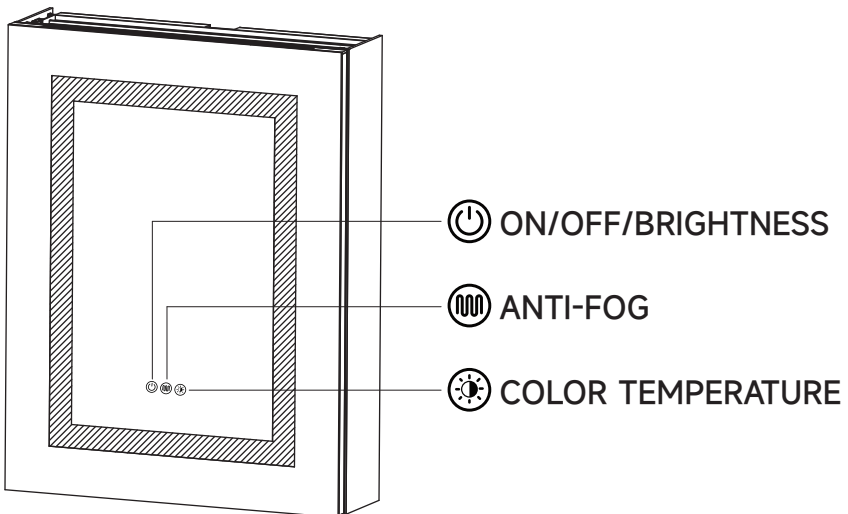

## 1. On/Off/Brightness Adjustment

- The button can control the light's on and off as well as brightness adjustment.
- Tap the button to turn on the light, and tap it again to turn off the light.
- Press and hold the button to adjust the brightness.
- In standby mode, press and hold the switch button to turn off all functions.

## 2. Anti-fog

- The anti-fog function can remove fog and maintain a clear reflective image. To save energy, it will automatically turn off after one hour.

## 3. Color Temperature







- Tap the button to select the color temperature: the first tap is for white light, the second tap is for warm light, and the third tap is for natural light.

---

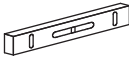
## Surface Mount Installation Method

### Installation tools

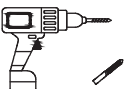
(the following tools are NOT INCLUDED in the package, you need to prepare them yourself)

Level Ruler 	Marker 	Hammer 	Tape Measure 
Electric Drill 	Screwdriver 	Safety Goggles 	

1

Place the 1 pc mounting bracket on the slot, measure the distance between the 2 side of the cabinet .

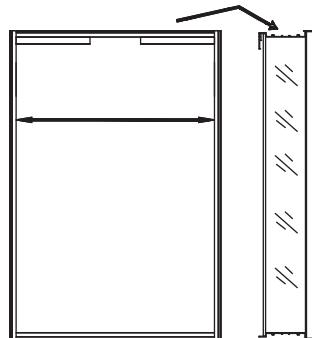

2

Place the led mirror cabinet against the wall and mark the placement of the cabinet. draw a line on the wall with a level and marker to indicate where the cabinet upper is and mark spots ①② for the lower brackets.

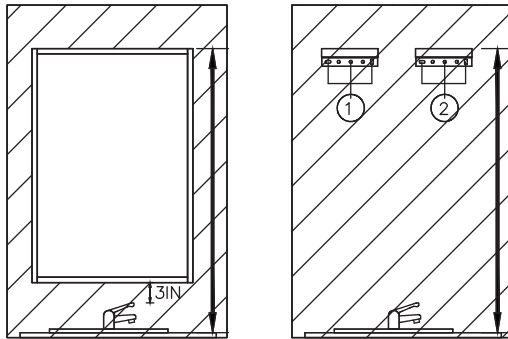

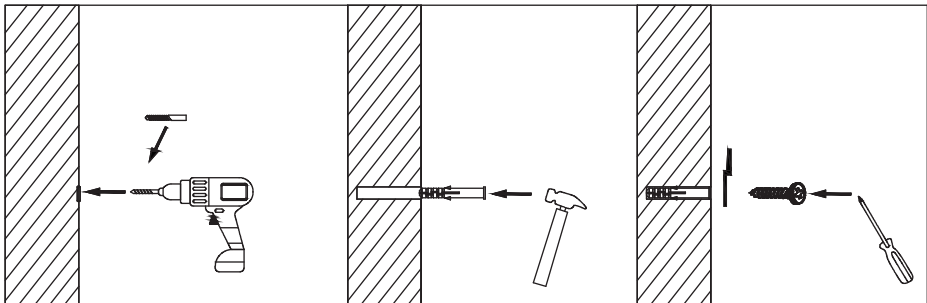

3

Use an electric drill to punch holes at the marked spots ①, then apply the 6 wall anchors with a hammer ②.

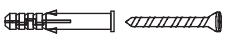

4

Thickness of wall:	Recommended drill bit:
> 5/8"(16MM)	5/16"(8MM) drill bit, drilling depth in 131/32"(50MM) 
5/16"(8)-5/8"(16MM)	25/64"(10mm) drill bit 
< 5/16"(8MM)	UNAPPLICABLE

**NOTE:**Please wear goggles and pay attention to your safety while drilling.

5

**Connect power through a hardwired.**

- Plug the cable plug that came with the mirror into the home outlet
- Hardwired

The mirror comes with an electrical outlet cut off.

Connect the cable that came with the mirror with the socket removed to the home wire.

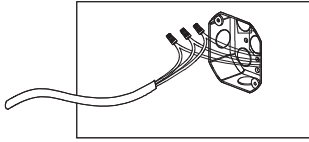

BLACK WIRE --- POWER SUPPLY L(LIVE)  
WHITE WIRE --- POWER SUPPLY N (NEUTRAL)  
GREEN WIRE --- POWER SUPPLY E (EARTH)

**WARNING: This mirror must be earthed.**

**REMINDER: Please make sure the power is cut off before installation.**

6

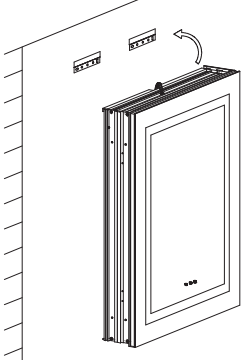

SIDE VIEW

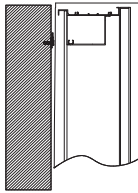

Wall mounted the  
mirror cabinet

7

Tear off the adhesive at the  
2 side of the mirror cabinet  
and stick it to the side of the  
aluminium surface.

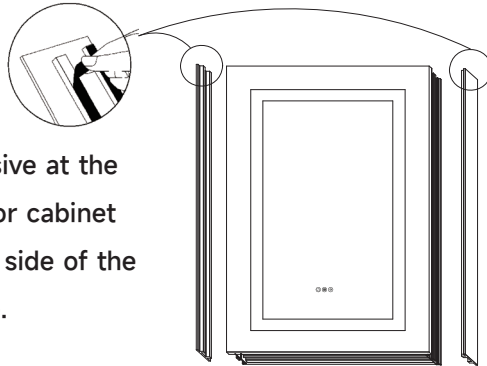

8

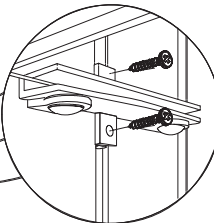
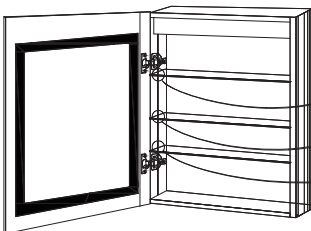

Using the+screwdriver to  
adjusting the tightness of  
the screws on the shelves.

# Recess Mount Installation Method

**1**

Make an outline for the cabinet (①), cut the marked perimeter through the drywall (②), and frame the cutout opening (③)

	20X26 Cabinet	19.72" (501mm) X25.7" (653mm) X4.17" (106mm)
	20X32 Cabinet	19.72" (501mm) X31.69" (805mm) X4.17" (106mm)
Outline size	24X30 Cabinet	23.74" (603mm) X29.65" (753mm) X4.17" (106mm)
	30X32 Cabinet	29.65" (753mm) X31.69" (805mm) X4.17" (106mm)
	32X36 Cabinet	31.69" (805mm) X35.75" (908mm) X4.17" (106mm)

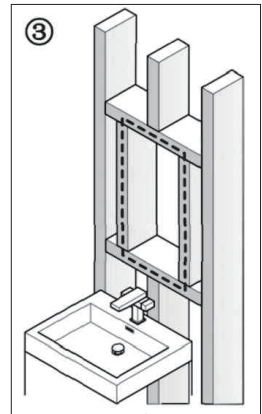
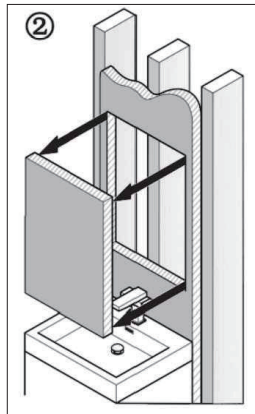
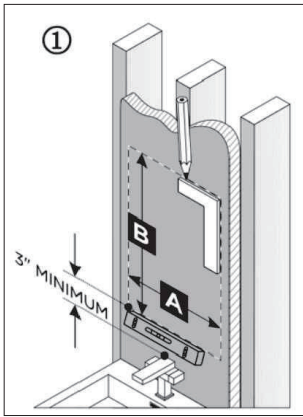

- Mark the center stud;
- Saw it for cabinet to rest on;
- Add additional 2 studs on the top and at the bottom of the opening to support the cabinet;
- Two more studs on both sides for the cabinet to be secured on.

## 4 STEPS TO FRAME THE CUTOUT OPENING

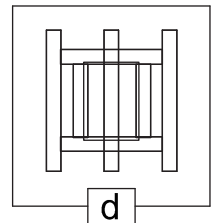
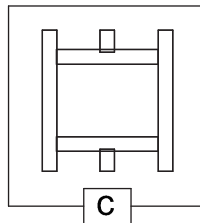
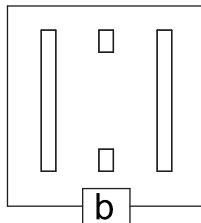
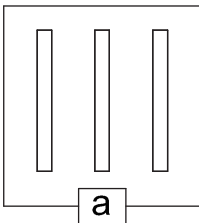

2

### Connect power through a hardwired.

- Plug the cable plug that came with the mirror into the home outlet
- Hardwired

The mirror comes with an electrical outlet cut off.

Connect the cable that came with the mirror with the socket removed to the home wire.

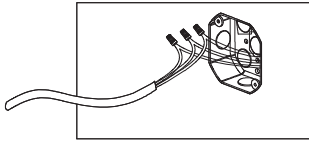

BLACK WIRE --- POWER SUPPLY L(LIVE)  
WHITE WIRE --- POWER SUPPLY N (NEUTRAL)  
GREEN WIRE --- POWER SUPPLY E (EARTH)

**WARNING: This mirror must be earthed.**

**REMINDER: Please make sure the power is cut off before installation.**

3

Position cabinet in cutout opening.

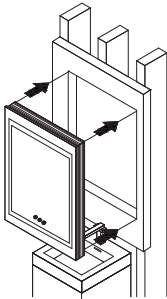

4

Use a pencil to set the point.

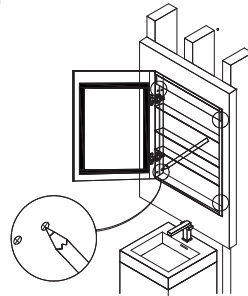

5

Punch holes at marked points and whack expansion tube into the holes.

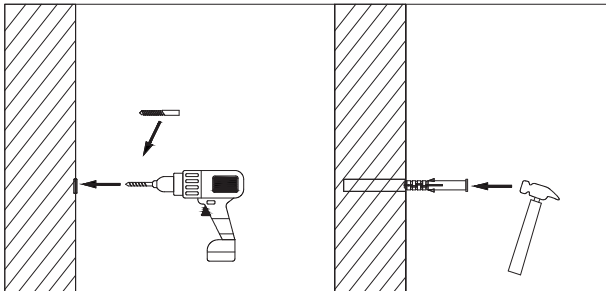

6

Secure it to the studs using screws

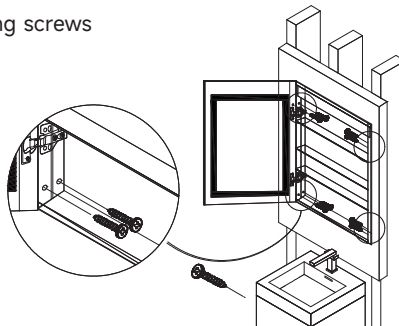

# Internal Hinge Installation

- Open the "DTC" cover in the direction of the arrow.
- Turn screw ❶ to adjust the depth of door overlay;
- Turn front screw ❷ to adjust the gap between the door and cabinet;
- Turn the eccentric screw ❸ to release the mounting plate from the cabinet, allowing the door to be moved up and down.

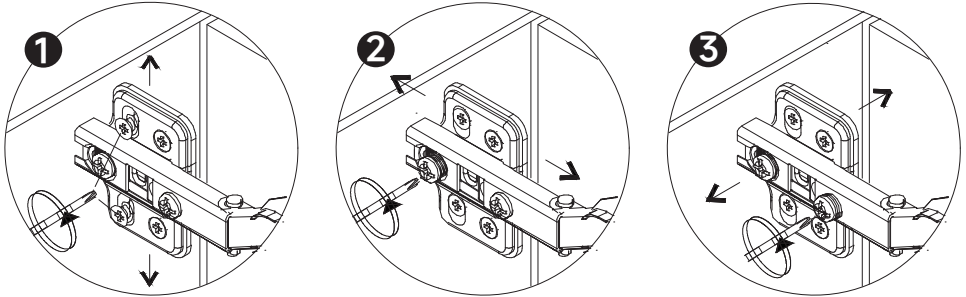

## DANGER

Risk of personal injury. To avoid possible electrical shock, the electricity must be turned off at the circuit breaker or fuse box before attempting any installation procedure.

Risk of personal injury. To avoid possible electrical shock, the mirror must be properly grounded.

## CAUTION

Maximum weight per shelf: 34 lbs/15.2 kg

## GROUNDING INSTRUCTIONS

This product must be connected to a grounded metal, permanent wiring system, or an equipment-grounding conductor must be run with the circuit conductors and connected to the equipment-grounding terminal or lead on the product.

## WARNING

An electrical option cabinet must be wired to a 20 amp gfi (Ground Fault Interrupter) protected circuit when used in bathrooms and all other locations required by the national electric code.

To reduce the risk of burns, fire, electric shock, or injury to persons, use this product only for the intended use as described in these instructions. Do not use accessories not recommended by the manufacturer. Do not drop or insert any objects into any openings. Do not use outdoors.

Risk of electric shock. Connect this product only to a properly grounded circuit. See grounding instructions.

## WARNING

1. All accessories must be installed in accordance with current IEE wiring regulations. If in doubt, consult a qualified electrician.
2. Switch off power at the main circuit board before installation and maintenance.
3. For use in bathroom zones 2, 3 and non-bathroom/dry areas. See diagram below.
4. Not for use over bathtubs or in zone 1, not for use in saunas, steam rooms or showers.
5. For indoor use only.
6. DO NOT fix to damp or conductive surfaces.
7. Keep away from curtains and fabrics.
8. Never cover the mirror.
9. Turn off the power after use.

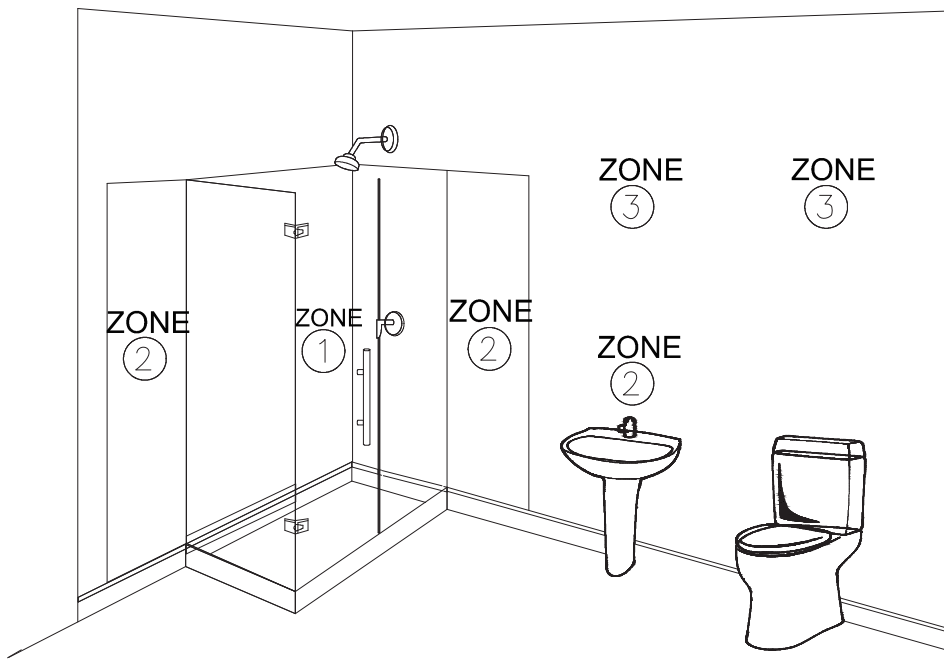

# WARNING

The lead contains 3 wires:

**COPPER WIRE (GREEN)** = EARTH WIRE...Connect to EARTH WIRE in your box, or to the box as a ground.

**BLACK** = LIVE WIRE... Connect to the BLACK LIVE WIRE in your box.

**WHITE** = NEUTRAL WIRE... Connect to the WHITE NEUTRAL WIRE in your box.

The wires will be connected to your 120 volt electric box.

This should be placed on the wall, behind your cabinet.

The suggested method for placement is towards the center, however there is flexibility with the lead wire.

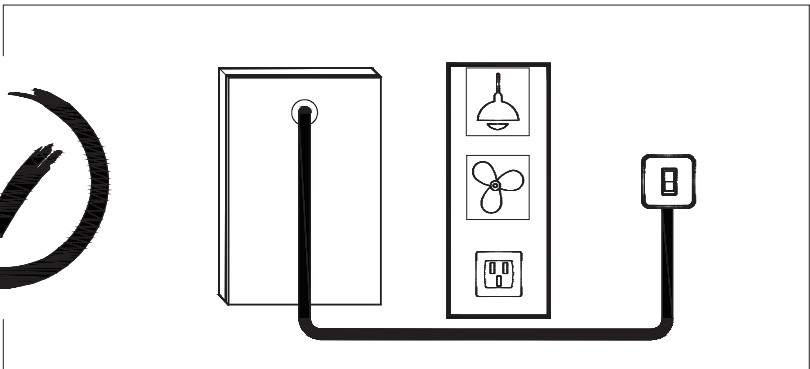
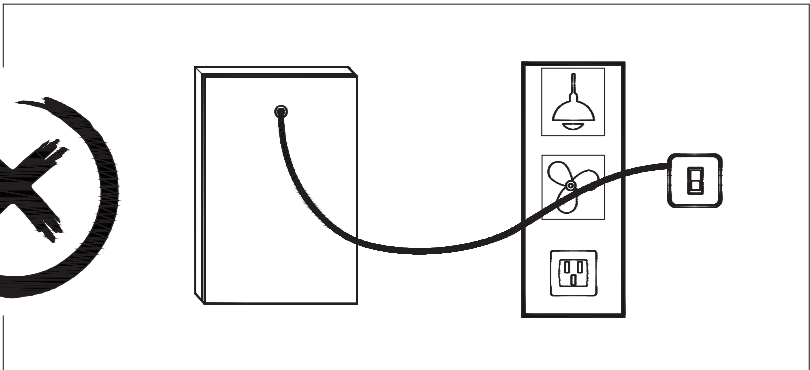

## SPECIFICATIONS

Size	Dimension	Types of led mirror cabinet
20"X26"X5.1"	50.8X66X13CM	Single-door
20"X32"X5.1"	50.8X81.2X13CM	Single-door
24"X30"X5.1"	61X76X13CM	Single-door
30"X32"X5.1"	76X81.2X13CM	Asymmetrical-door
32"X36"X5.1"	81.2X91.5X13CM	Asymmetrical-door

PARAMETER	SPECIFICATION
Color temperature	3000K-6500K
Input voltage	AC110-120V
Output voltage	24V DC
CRI	≥80 Ra
Working temperature	-10~45°C
Life span	25000 hours
Anti-fog	Yes
Wiring method	Hardwired
Switch	Touch sensor switch



If you have any questions, please contact our Customer Service:

✉ Email: [support@woodsam.com](mailto:support@woodsam.com)