

Assembly Instructions

LOVESEAT

CAUTION: You must read this before you proceed.

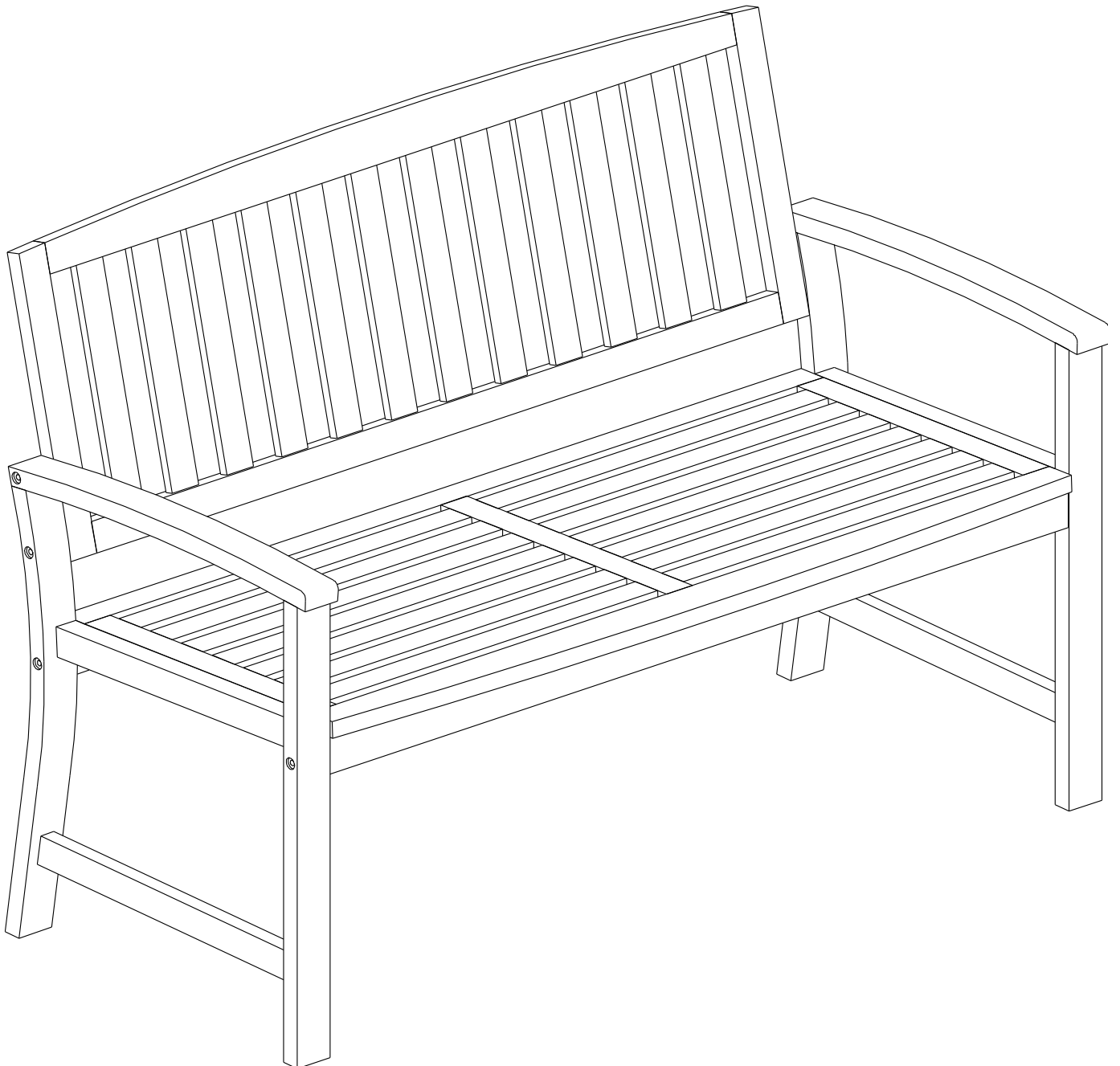

CAUTION : This Loveseat is NOT a TOY.



Keep your child / children at bay in the process of assembly.

For turning the Loveseat and to prevent damage to the End Table, 02 persons may be needed to execute this action.

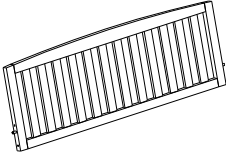
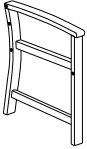
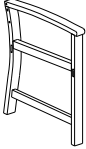
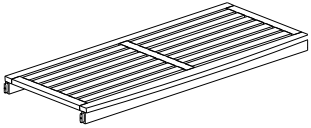
Parts List

No.	Picture	Description	Qty
A		Backrest Panel	1
B		Left Arm Panel	1
C		Right Arm Panel	1
D		Seat Panel	1

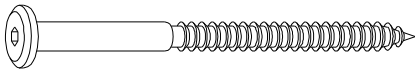
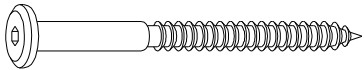



Hardware

No.	Picture	Description	Qty
①		Long Screws (M7x90mm)	5
②		Short Screws (M7x70mm)	5
③		Allen Wrench	1

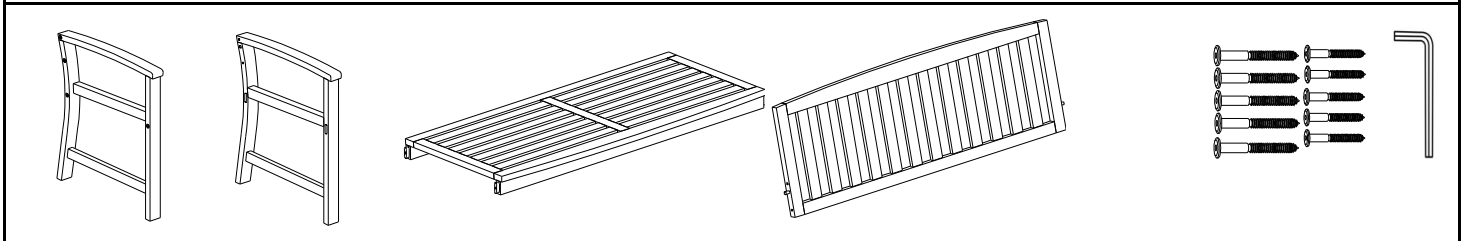
Assembly Preparation

Before Beginning Assembly:



-  Read instructions, cover to cover.
-  Have 2 adults on hand for assembly.
-  Do not assemble on flooring or carpet.
-  Assemble on a clean non-marring surface (packing foam).
-  Save all packaging until finished.

Assembly Steps

OVERVIEW

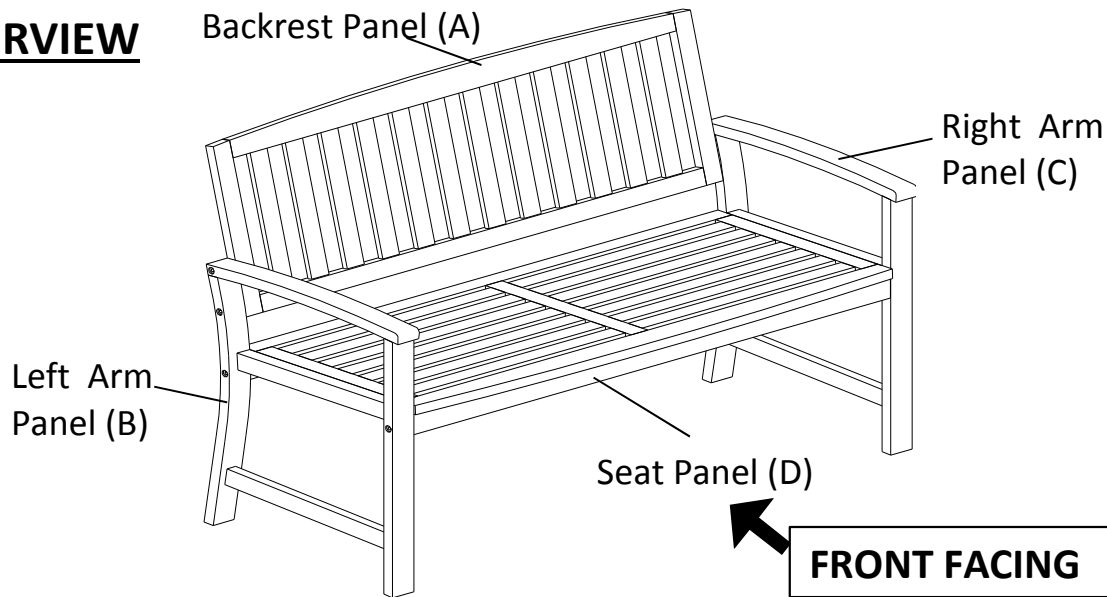

This Loveseat has multiple parts and may require up to 30 minutes to assemble. To give you an overview of the Loveseat parts, the above picture is to help you put the various parts into perspective. Please read through the instructions herebelow to familiarise the parts and steps before assembly.

Step 1

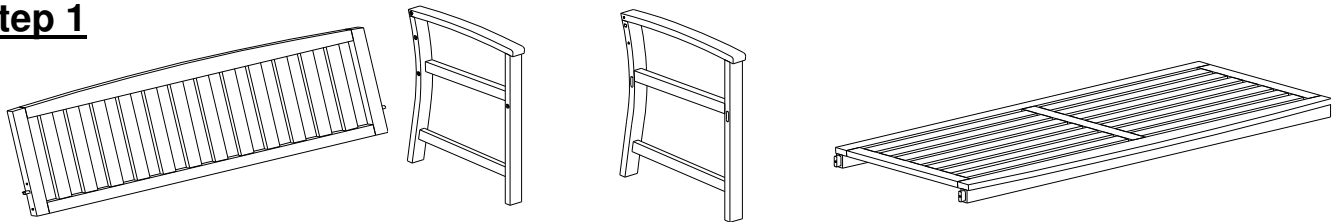

Unpack and place all parts on a clean, non-marring surface.

Step 2

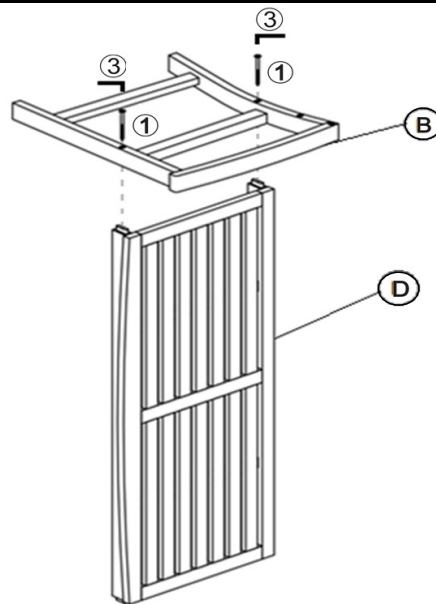

Place the Seat Panel (D) with its one side face skywards onto a clean, soft surface to avoid any scratches or damages to the product.
Align the tenon of Seat Panel (D) into the Mortise of Left Arm Panel (B) as shown above.
Then, affix the Seat Panel (D) with Left Arm Panel (B) by using Long Screws (①) and Allen Wrench (③).

DO NOT FULLY TIGHTEN SCREWS.

Step 3

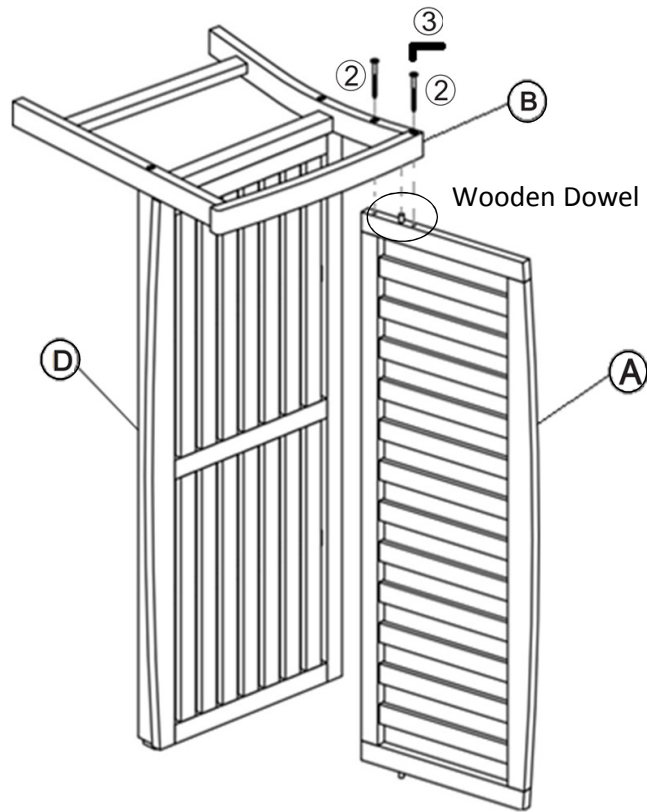

Then continue position Backrest Panel (A) as shown in picture above.

Align the wooden dowel into the positions in the arms.

Then, affix Left Arm Panel (B) with Backrest Panel (A) by using Short Screws (2) and Allen Wrench (3)

DO NOT FULLY TIGHTEN SCREWS.

Step 4

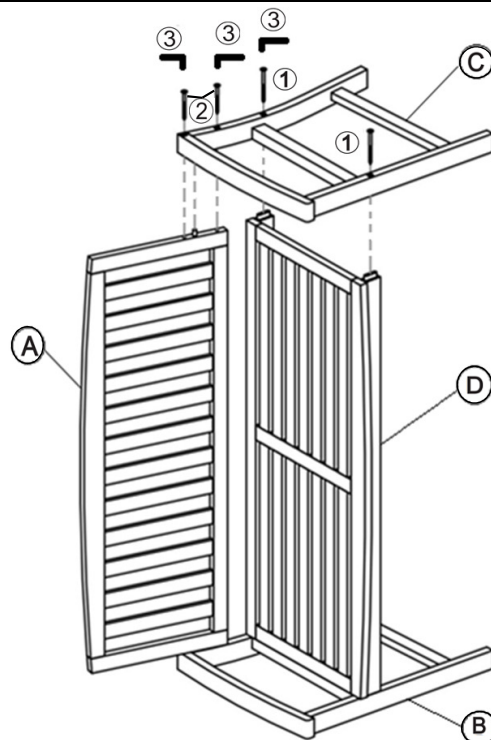

With the help from your partner, turn the Loveseat to rest on Left Arm Panel (B) so that Right Arm Panel (C) is now facing skywards.

Repeat the same process by affixing Screws (1), (2) to designated points.

DO NOT FULLY TIGHTEN SCREWS.

Step 5

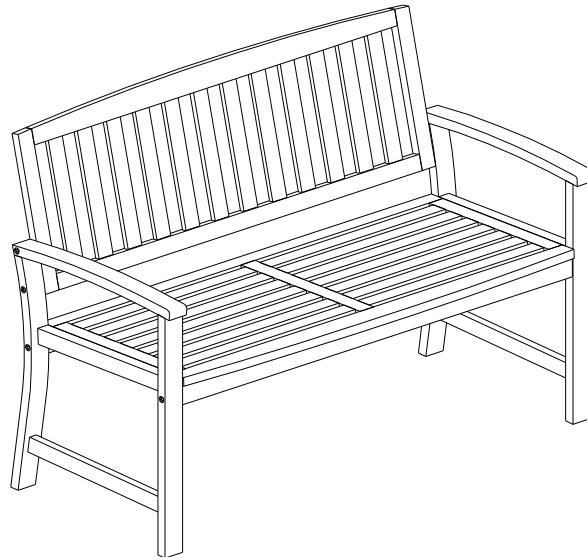

Turn the Loveseat right side up.
Place the Loveseat on a **LEVEL SURFACE**.
Inspect it and make sure all parts are adequately connected.
Gently and gracefully, sit into to the Loveseat.
This would help to align all the parts at all the joint areas.

Then get off the Loveseat, and in a sequential manner, proceed to tighten all screws.
To tighten the Screws at the base of the Backrest, do secure assistance from your adult partner(s).
You may be required to turn the Loveseat, to gain easy access to the secure points.
Turn the Loveseat in a synchronised manner.





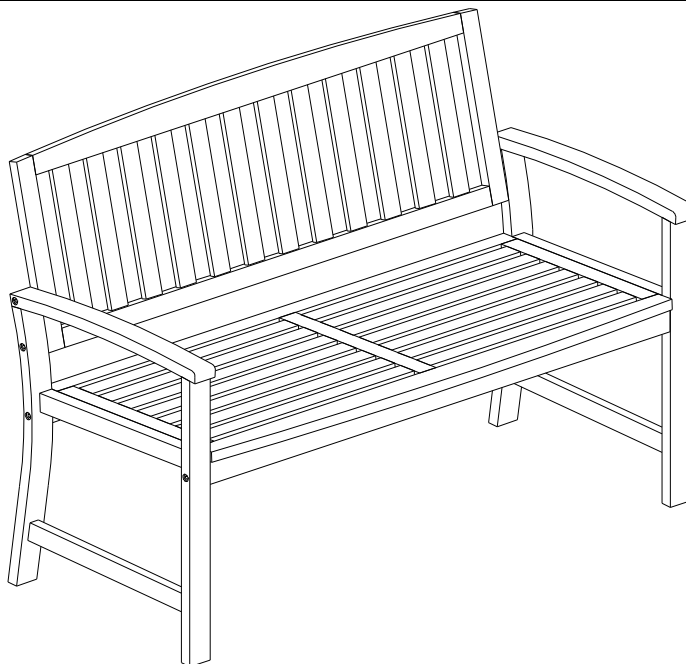



CAUTION: When tightening these screws, tighten sequentially.
DO NOT tighten any screw fully and then towards the next one.
This would cause the frame to warp.
If there is still wobbles, loosen the screws and execute this same process.
WARNING!! IF LOVESEAT IS NOT STABLE , IT COULD LEAD TO DAMAGING THE PRODUCT.

Step 6



Ensure all screws are fully locked into position.
The Loveseat is ready to be used.
Caution: This Loveseat can only be used on a flat, level surface.

Care & Maintenance

- ⊘  ● Do not put hot items directly on furniture surface.
 - ⊘  ● Do not clean furniture with harsh cleansers or polish.
 - ✓  ● To obtain the longest lifespan of your outdoor products, minimizing exposure to direct sunlight is recommended.
 - ⊘  ● Children should not climb or jump on the furniture.
 - ⊘  ● Do not write on furniture without a padded barrier to protect the surface.
 - ✓  ● To obtain the longest lifespan of your outdoor products, avoid extended and lengthy exposure to rain, snow, and direct sunshine. Whenever possible cover the product and /or place under patio or awnings.
 - ⊘  ● Not for commercial use. For residential use only.
 - ⊘  ● Stains may be removed with mild soap solution and damp cloth.
 - ✓  ● Dust and pick-up spills using a clean, non-colored, lint-free cloth .
-