

Kids Kitchen Playset

— Assembly Instruction —



TRACKING NUMBER: BJ10240032



⚠ WARNING:
CHOKING HAZARD - Small parts
Not for children under 3 years

⚠ WARNING:
ADULT ASSEMBLY REQUIRED
Assembly instructions included.

USE AND MAINTENANCE:

Use on level surfaces only Please check assembly at regular intervals, and frequently tighten hardware if necessary. If maintenance is not carried out, the product could cease to function properly

! WARNING

- **INGESTION HAZARD:** This product contains a button cell or coin battery.
- **DEATH** or serious injury can occur if ingested.
- A swallowed button cell or coin battery can cause **Internal Chemical Burns** in as little as **2 hours**.
- **KEEP** new and used batteries **OUT OF REACH of CHILDREN**
- **Seek immediate medical attention** if a battery is suspected to be swallowed or inserted inside any part of the body.



- a) The statement "Remove and immediately recycle or dispose of used batteries according to local regulations and keep away from children. Do NOT dispose of batteries in household trash or incinerate."
- b) The statement "Even used batteries may cause severe injury or death."
- c) The statement "Call a local poison control center for treatment information."
- d) A statement indicating the compatible battery type (e.g., LR44, CR2032, 3x1.5V).
- e) A statement indicating the nominal battery voltage.
- f) The statement "Non-rechargeable batteries are not to be recharged."
- g) The statement "Do not force discharge, recharge, disassemble, heat above (manufacturer's specified temperature rating) or incinerate. Doing so may result in injury due to venting, leakage or explosion resulting in chemical burns."

- a) The statement "Ensure the batteries are installed correctly according to polarity (+ and -)."
- b) The statement "Do not mix old and new batteries, different brands or types of batteries, such as alkaline, carbon-zinc, or rechargeable batteries."
- c) The statement "Remove and immediately recycle or dispose of batteries from equipment not used for an extended period of time according to local regulations."
- d) The statement "Always completely secure the battery compartment. If the battery compartment does not close securely, stop using the product, remove the batteries, and keep them away from children."

NOTICE

- Please retain these instructions for future reference.
- Do not stand on or use any part of this set as a step ladder.
- Firmly secure all bolts, screws and knobs before use.
- Reconfirm that all bolts, screws, and knobs are secure every 90 days.
- Be aware that some parts are heavy and have sharp edges.
- Do not use or store this item in the proximity of open flame or flammable/combustible chemicals.
- If any parts are missing, broken, damaged, or worn, stop using this product until repairs are made and/or factory replacement parts are installed.
- Do not use this item in a way inconsistent with the manufacturer's instructions as this could void the product warranty.
- **AGE RANGE:** 3 years old and up.

TOOLS REQUIRED



**ALLEN WRENCH
(PROVIDED)**



**DRILL
(RECOMMENDED)**



**2 PEOPLE
ASSEMBLY**



**UP TO 6 HOURS
ASSEMBLY**

Product Overview - Box A





















INSTRUCTION VIDEO

Product Overview - Box B

















INSTRUCTION VIDEO

PART AND HARDWARE LIST-BOX A

B 4 X 30MM  111pcs	C 3 X 18MM  6pcs	D 4 X 18MM  33pcs	F 3 X 14MM  6pcs	G 3 X 8MM  109pcs
H  109pcs	J  10pcs	K  10pcs	L  22pcs	M  10pcs
N  3pcs	O  4pcs	P  1pc	Q  3pcs	R  1pc
S  1pc	U White Light  1pc	V Yellow Light  1pc	W Red Light  1pc	

PARTS LIST-BOX A

22  2pcs	23  2pcs	24  1pc	25  1pc	26  1pc
27  1pc	28  2pcs	29  1pc	30  1pc	31  1pc
32  1pc	33  1pc	34  1pc	35  1pc	36  1pc

PARTS LIST-BOX A

37



2pcs

38



1pc

39



1pc

40



1pc

41



1pc

42



1pc

43



1pc

44



1pc

45



1pc

46



1pc

47



1pc

48



1pc

49



1pc

50



1pc

51



1pc

52



1pc

53



1pc

54

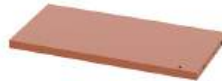

1pc

55

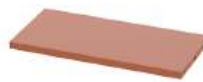

1pc

56



1pc

57



1pc

58



1pc

59



1pc

60



1pc

61



1pc

62



1pc

63



1pc

64



1pc

65



1pc

66



1pc

67



1pc

68



2pcs

69



1pc

70



1pc

71



1pc

72



1pc

73



1pc

74



1pc

75

























1pc

76



1pc

PARTS LIST-BOX A

<p>77</p>  <p>1pc</p>	<p>78</p>  <p>1pc</p>	<p>79</p>  <p>1pc</p>	<p>80</p>  <p>1pc</p>	<p>81</p>  <p>1pc</p>
<p>82</p>  <p>1pc</p>	<p>83</p>  <p>1pc</p>	<p>84</p>  <p>2pcs</p>	<p>85</p>  <p>1pc</p>	<p>86</p>  <p>2pcs</p>
<p>87</p>  <p>1pc</p>	<p>88</p>  <p>1pc</p>	<p>89</p>  <p>2pcs</p>	<p>90</p>  <p>1pc</p>	<p>91</p>  <p>1pc</p>
<p>92</p>  <p>6pcs</p>	<p>93</p>  <p>3pcs</p>	<p>94</p>  <p>7pcs</p>	<p>95</p>  <p>2pcs</p>	<p>96</p>  <p>1pc</p>
<p>97</p>  <p>1pc</p>	<p>98</p>  <p>1set</p>			

ASSEMBLY INSTRUCTION-BOX A

Step 1 **D**X2 **G**X4 **L**X1 **K**X1



Step 2 **D**X2 **G**X4 **L**X1 **K**X1



Step 3 **D**X2 **G**X4 **L**X1 **K**X1

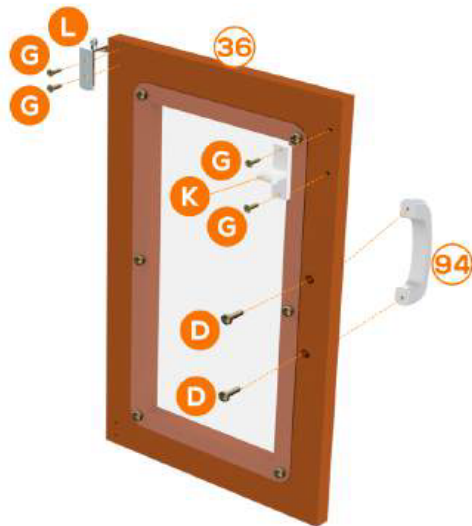

Step 4 **D**X2 **G**X4 **L**X1 **K**X1

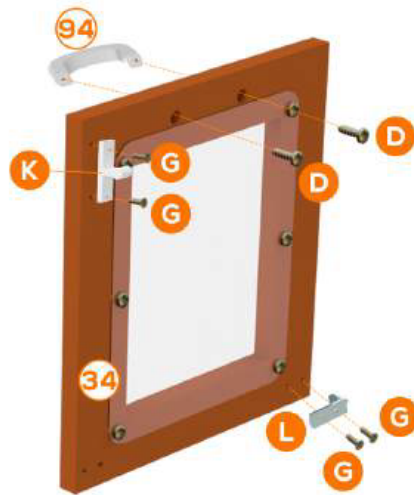

Step 5 **G**X5 **M**X5

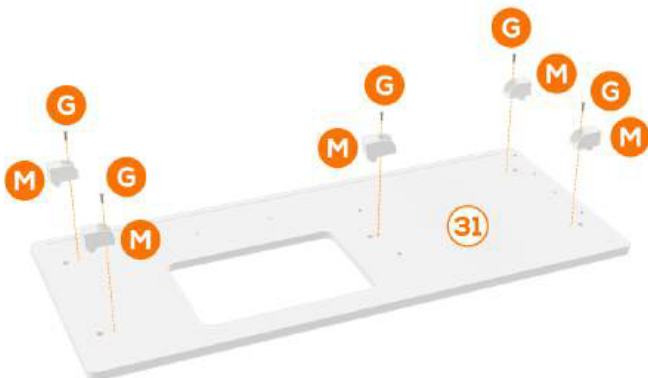

Step 6 **C**X2



ASSEMBLY INSTRUCTION-BOX A

Step 7 **Bx4**

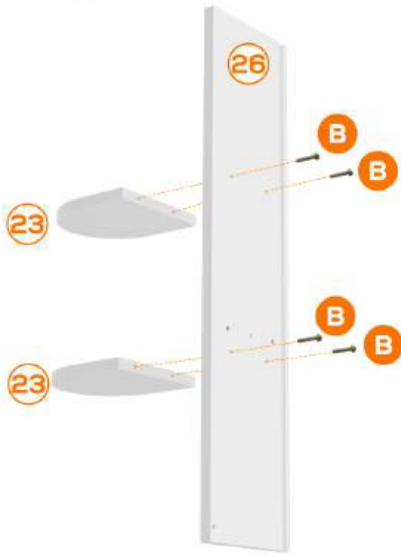

Step 8 **Bx1 Hx6**

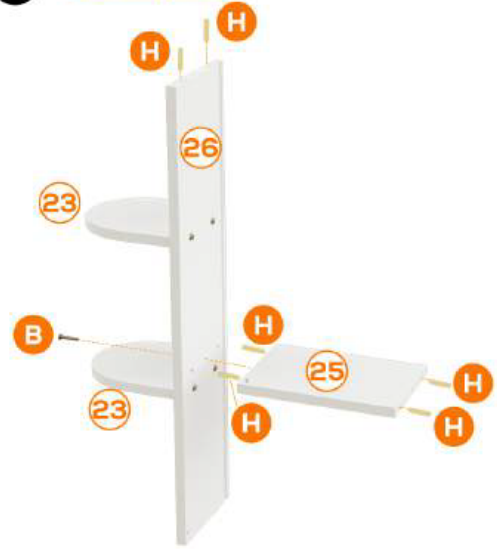

Step 9 **Bx1 Gx4 Hx2 Jx2**

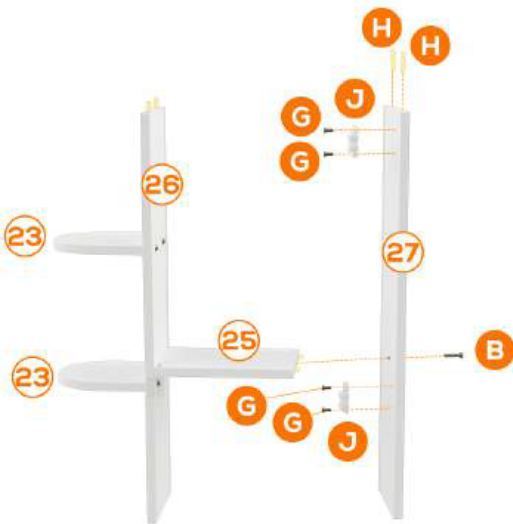

Step 10 **Bx2**



Step 11 **Cx4 Ox4**

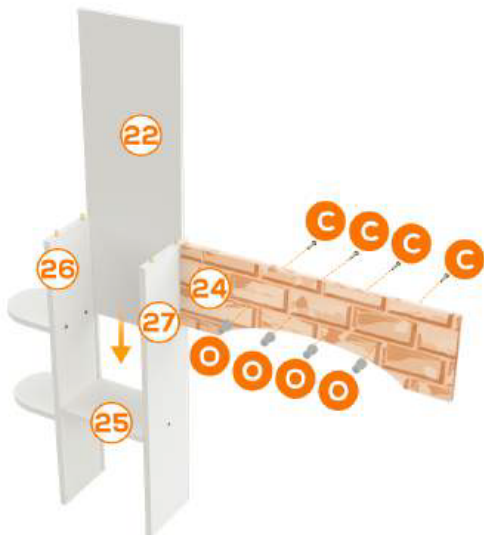

Step 12 **Bx6**

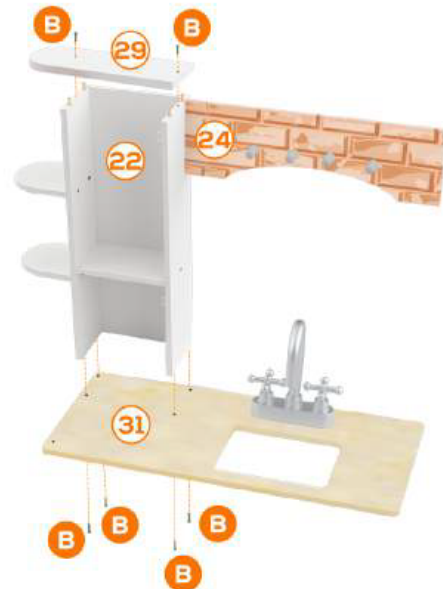

Step 13 **Gx4 Lx2**

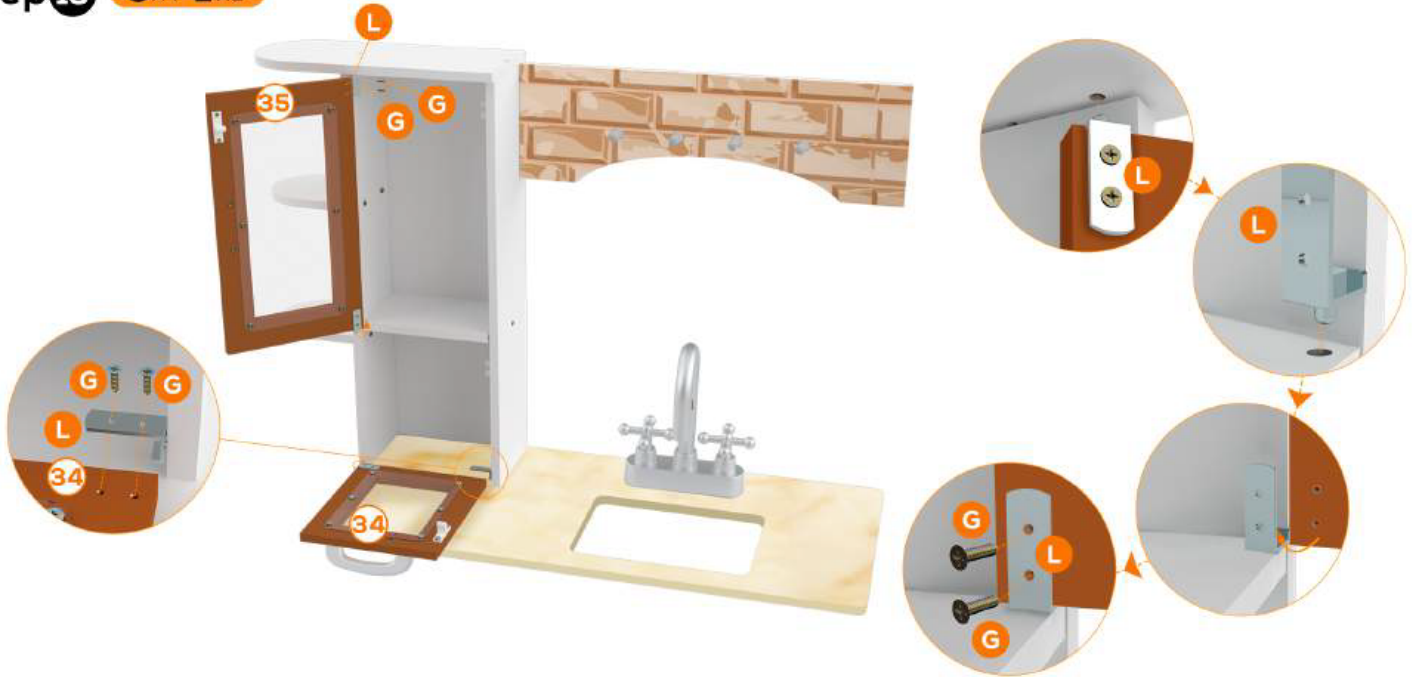

Step 14 **Bx1**

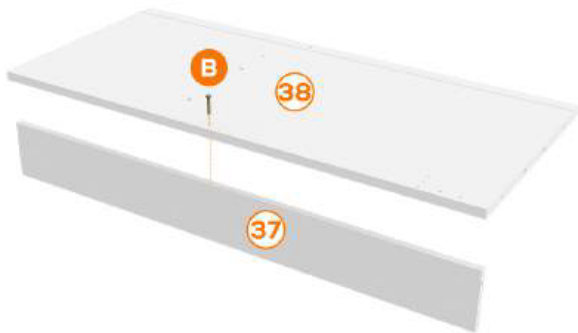

Step 15 **Bx1**

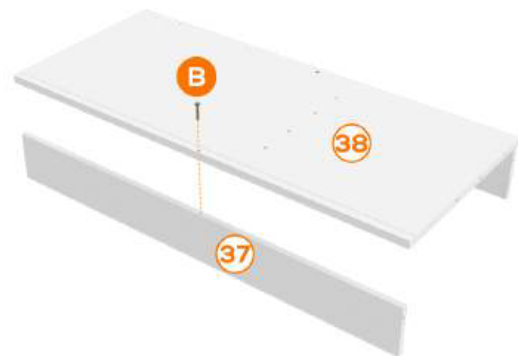

Step 16 **Gx2 Hx8 Qx1**

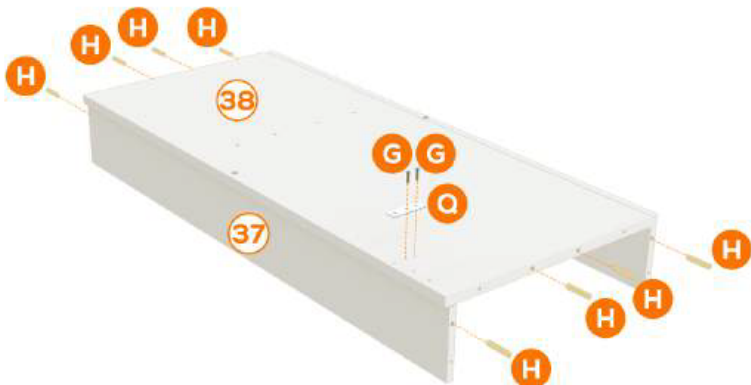

Step 17 **Bx1 Gx2 Hx8 Jx1**

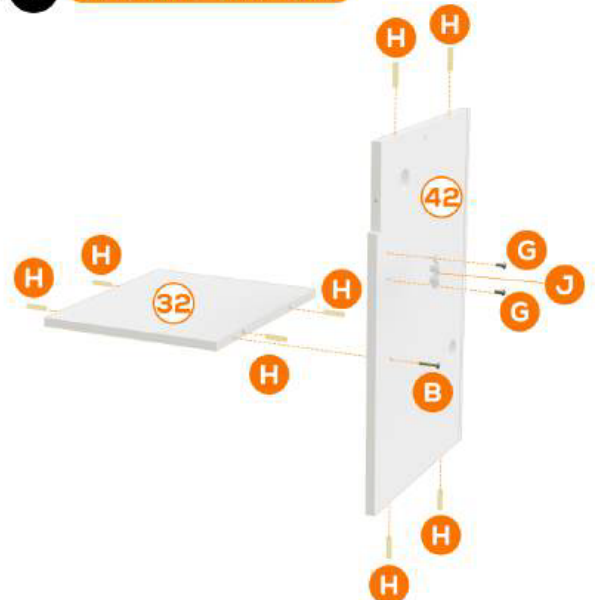

Step 18 B X2



Step 19 B X5 H X6

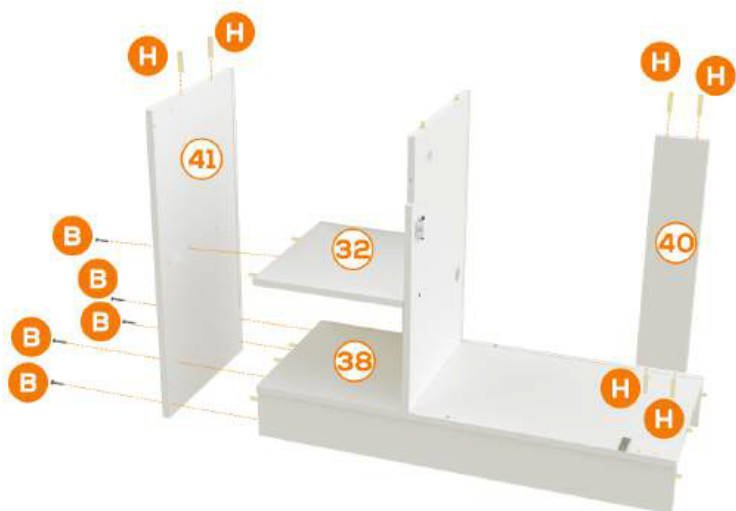

Step 20 F X2 G X2 N X1 U X1



Step 21 D X2 G X4 L X1 K X1

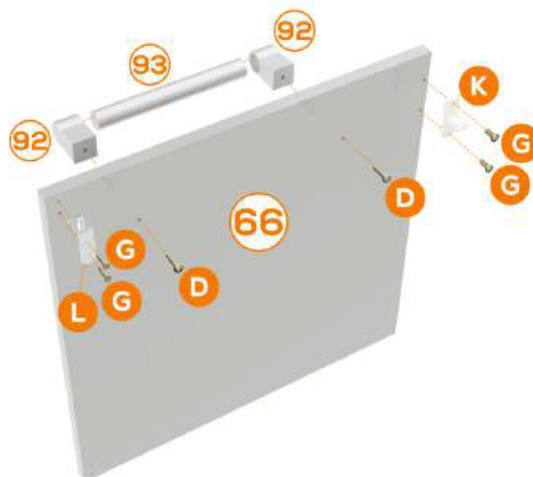

Step 22 B X1 H X2

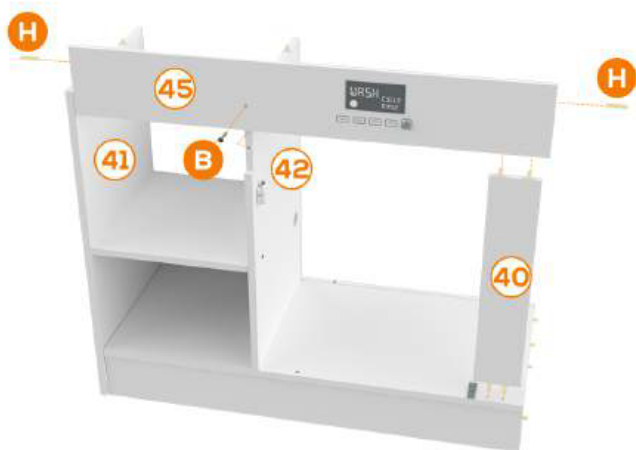

ASSEMBLY INSTRUCTION-BOX A

Step 23 B X1 G X2 L X1

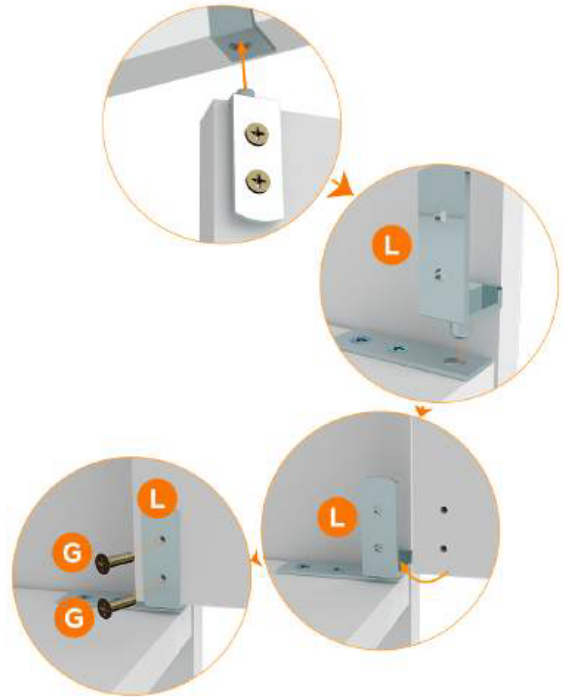

Step 24



Step 25 B X7 H X2

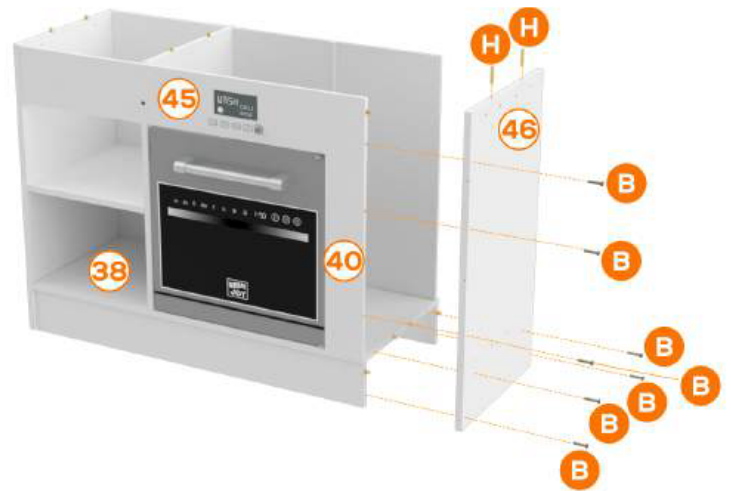

Step 26 G X2 L X1 H X6 F X2 V X1

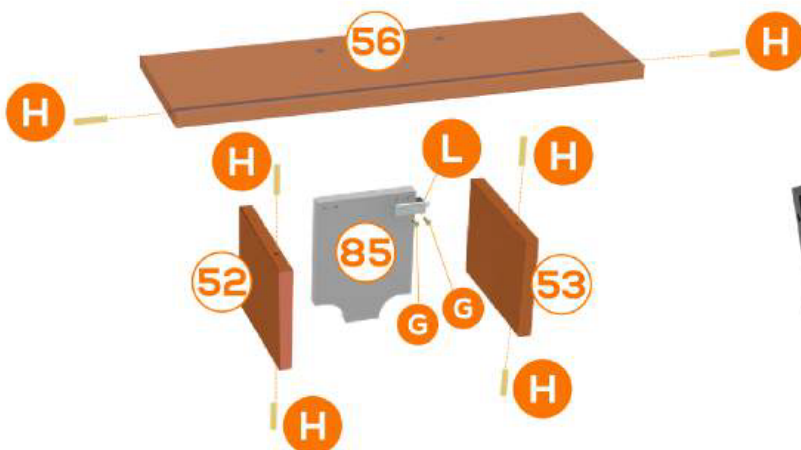

ASSEMBLY INSTRUCTION-BOX A

Step 27 **B X2 G X2 L X1**

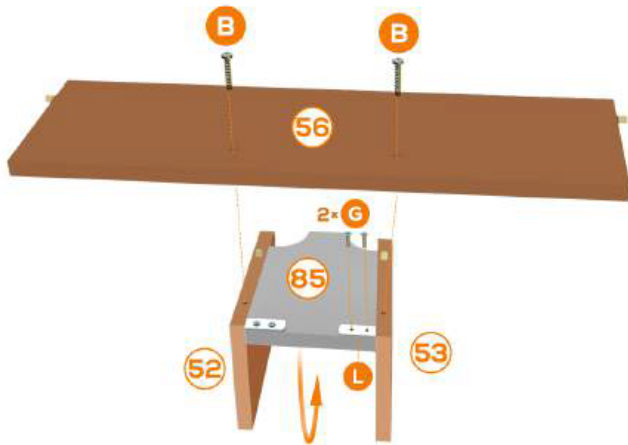

Flip No.85 and fasten the screws

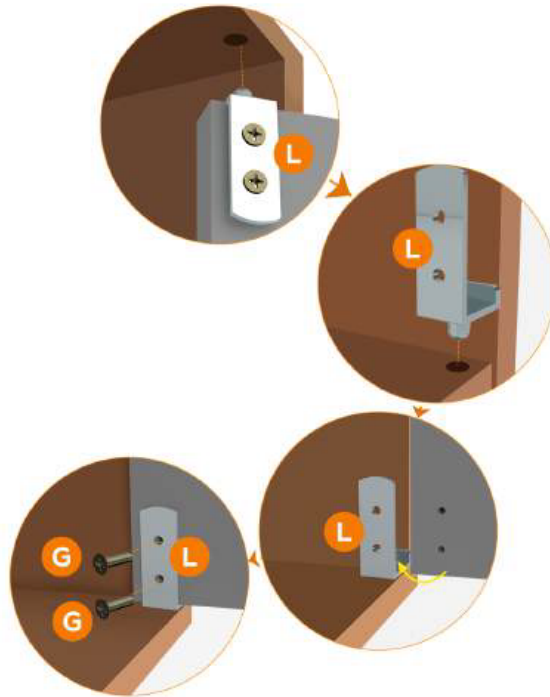

Step 28 **B X2 H X4**

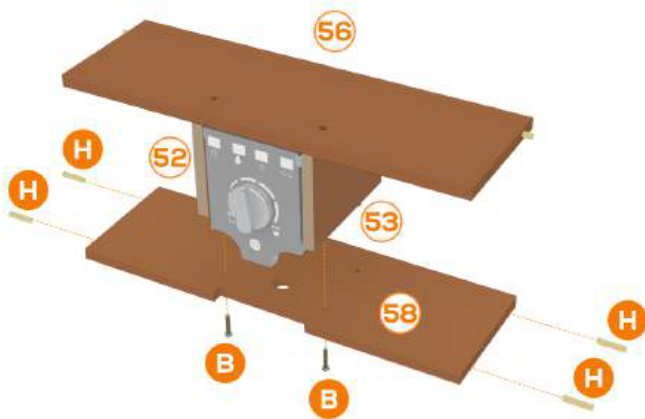

Step 29 **H X6 B X1**

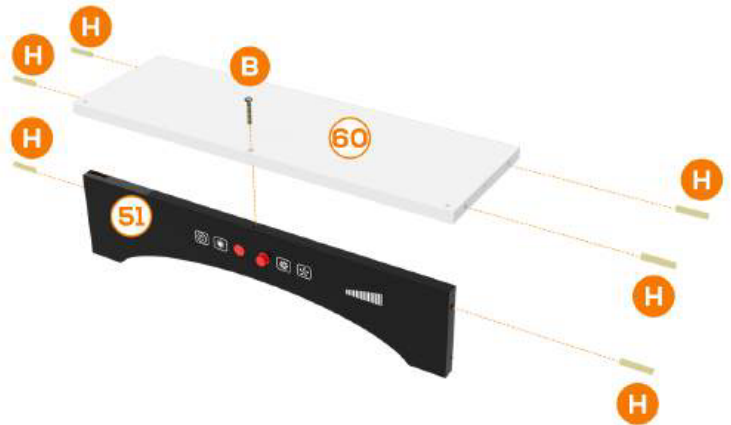

Step 30 **B X2**

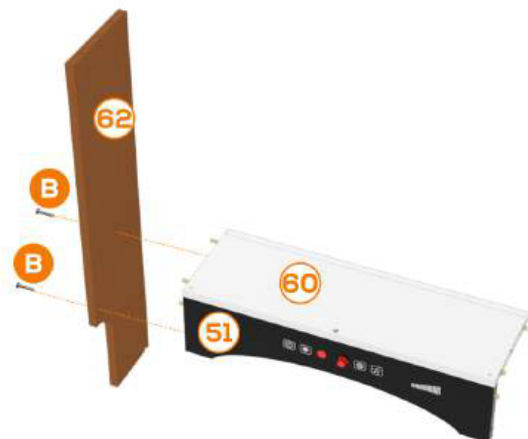

Step 31 **G X2 B X2 J X1**

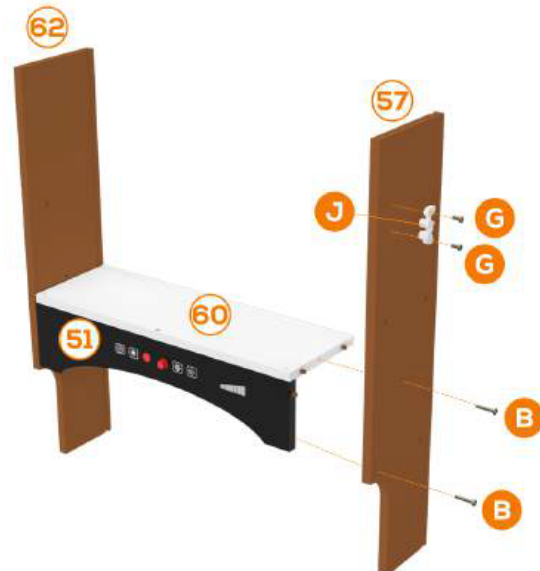

ASSEMBLY INSTRUCTION-BOX A

Step 32 **Dx4 Gx8 Lx2 Kx2**

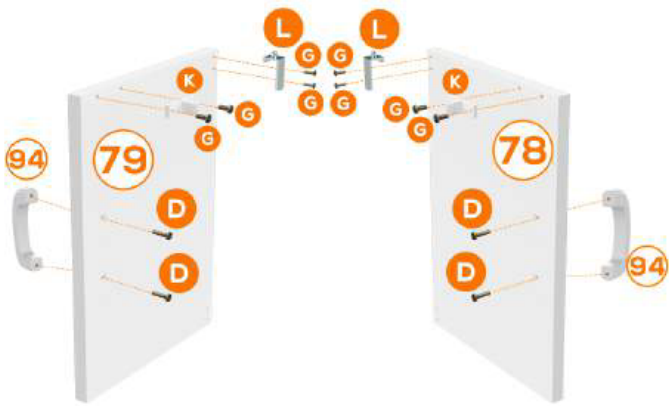

Step 33 **Gx12 Dx6 Lx3 Kx3**

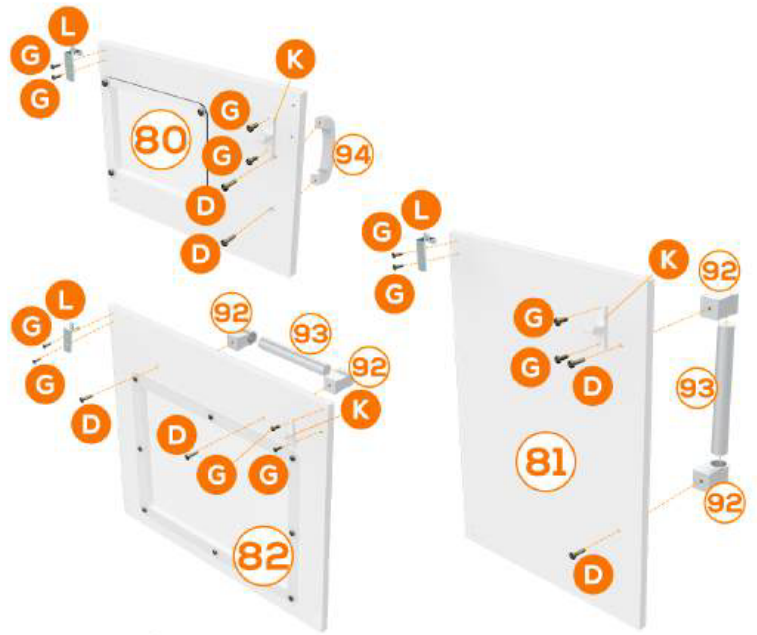

Step 34 **Gx4 Hx8 Jx2**

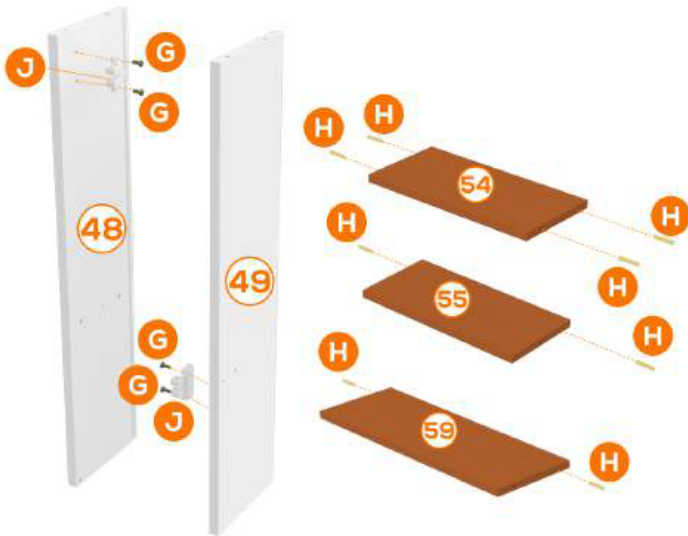

Step 35 **Bx2**

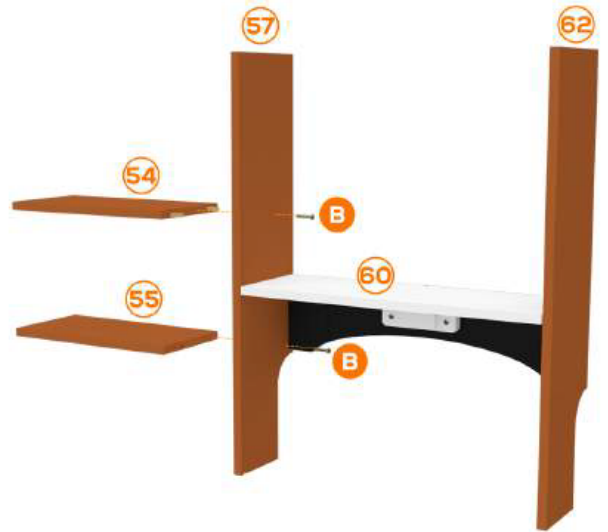

Step 36 **Bx3**



Step 37



ASSEMBLY INSTRUCTION-BOX A

Step 38 B X3



Step 39 B X2 H X4

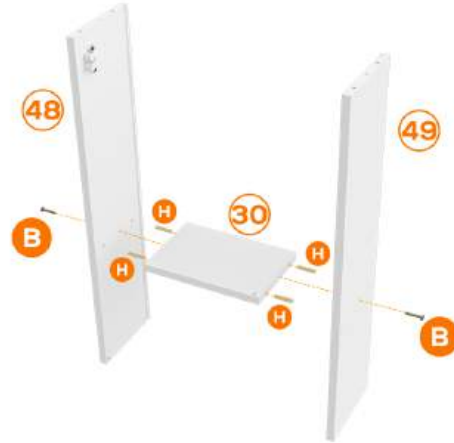

Step 40 G X5 M X5

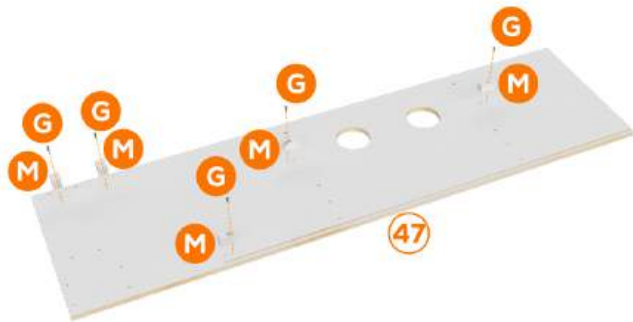

Step 41 B X11

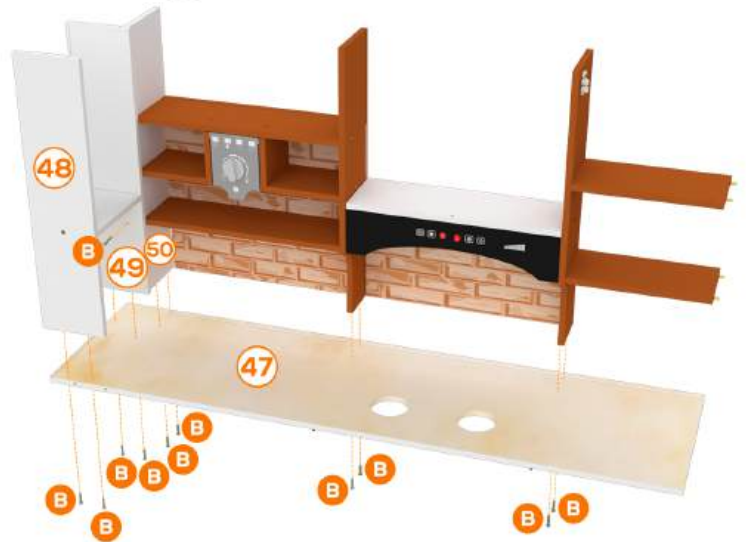

Step 42 B X2 G X4 H X6 Q X2

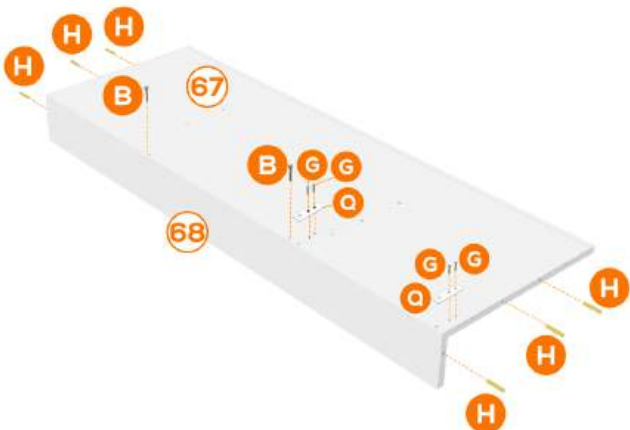

Step 43 B X2 H X2

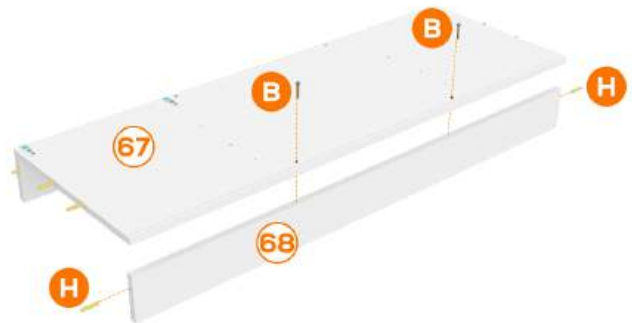

ASSEMBLY INSTRUCTION-BOX A

Step 44 HX12 GX4 JX2

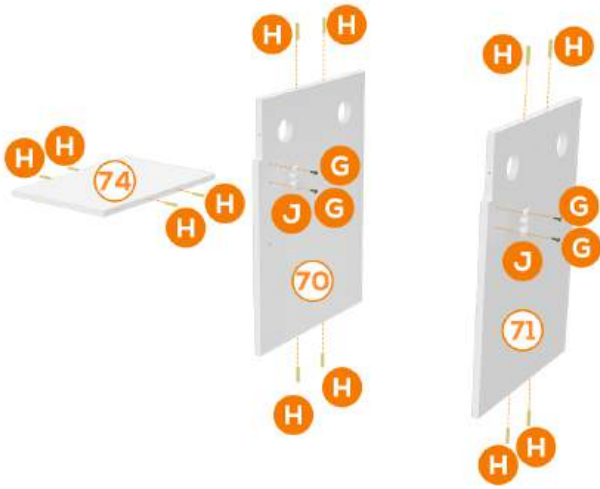

Step 45 BX1



Step 46 BX4

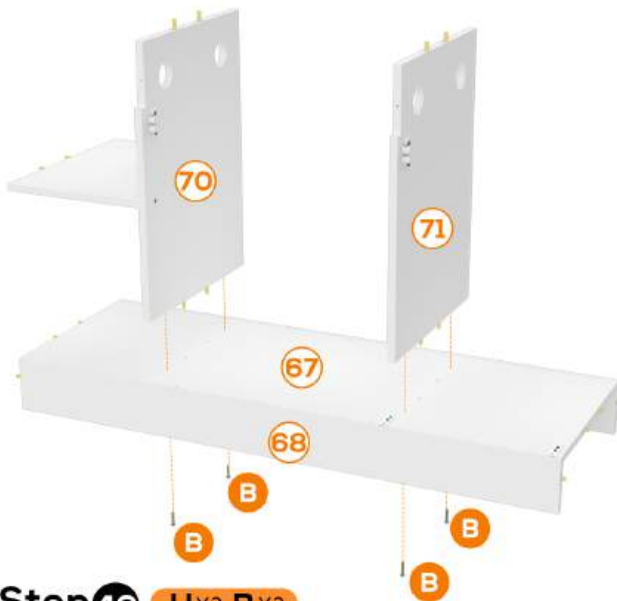

Step 47 GX4 NX2 WX1 FX2

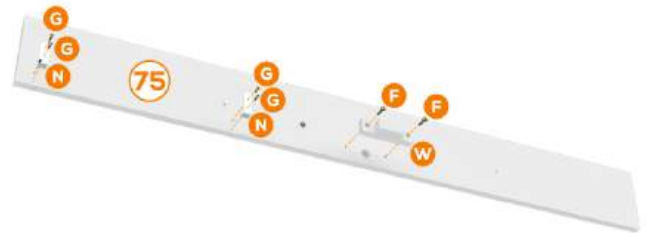

Step 48 HX2 BX2

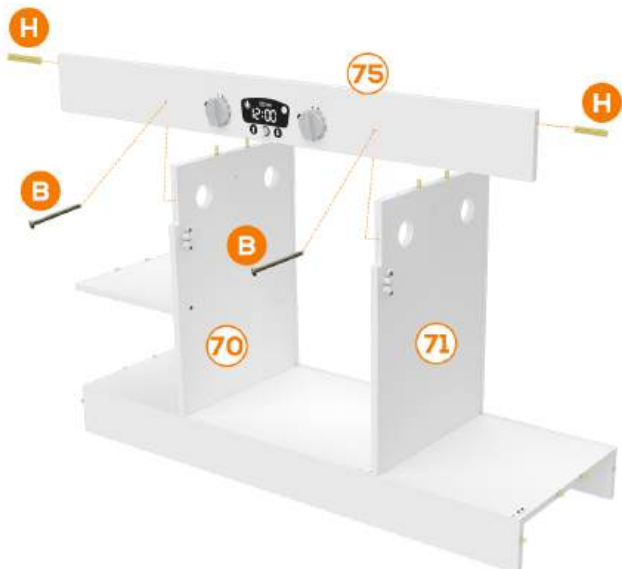

Step 49

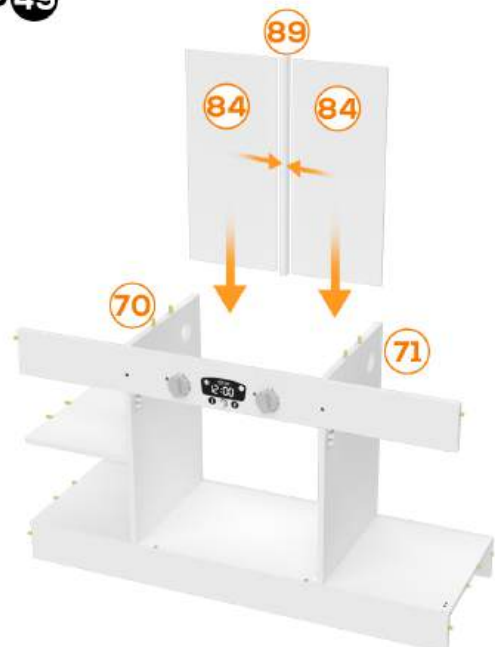

ASSEMBLY INSTRUCTION-BOX A

Step 50 H X2



Step 51 B X6

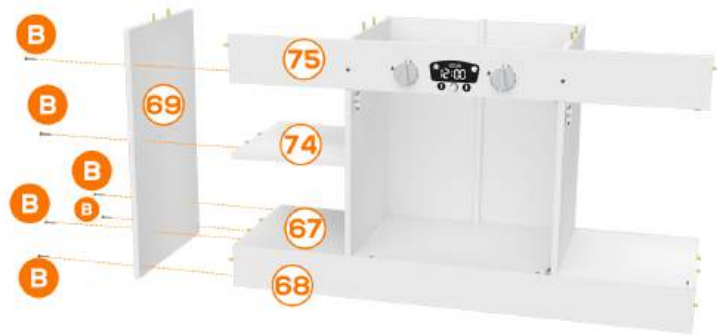

Step 52

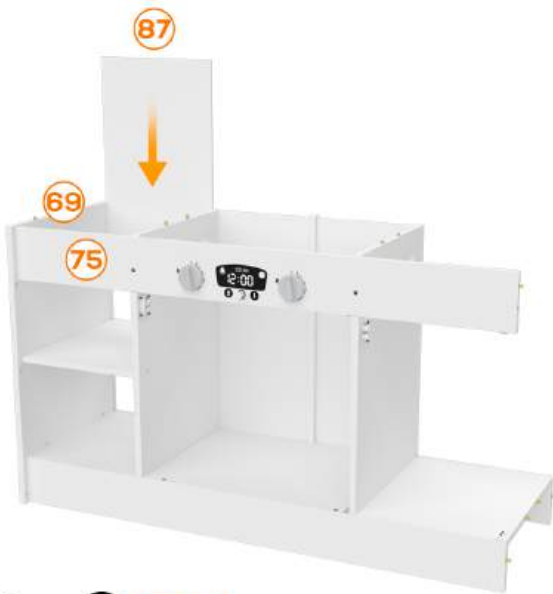

Step 53 H X4

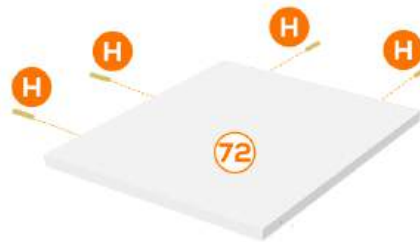

Step 54 B X2

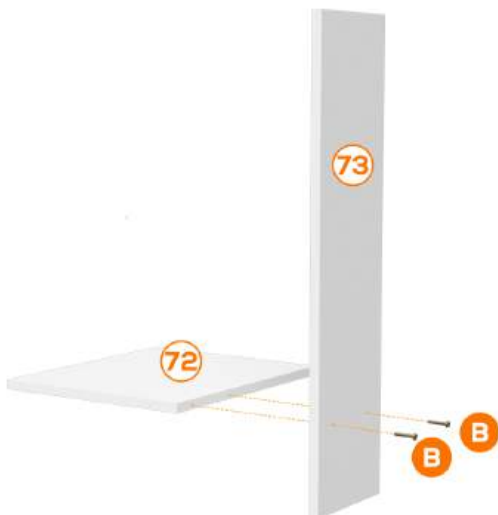

Step 55 B X2



ASSEMBLY INSTRUCTION-BOX A

Step 56 B X2 D X3



Screw #D horizontally into #M

Step 57



Step 58 H X14 B X9

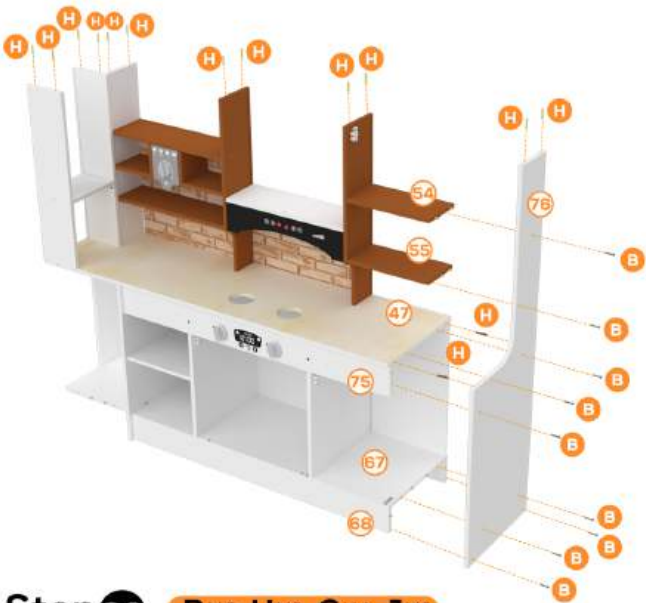

Step 59



Step 60 B X6 H X2 G X4 J X2

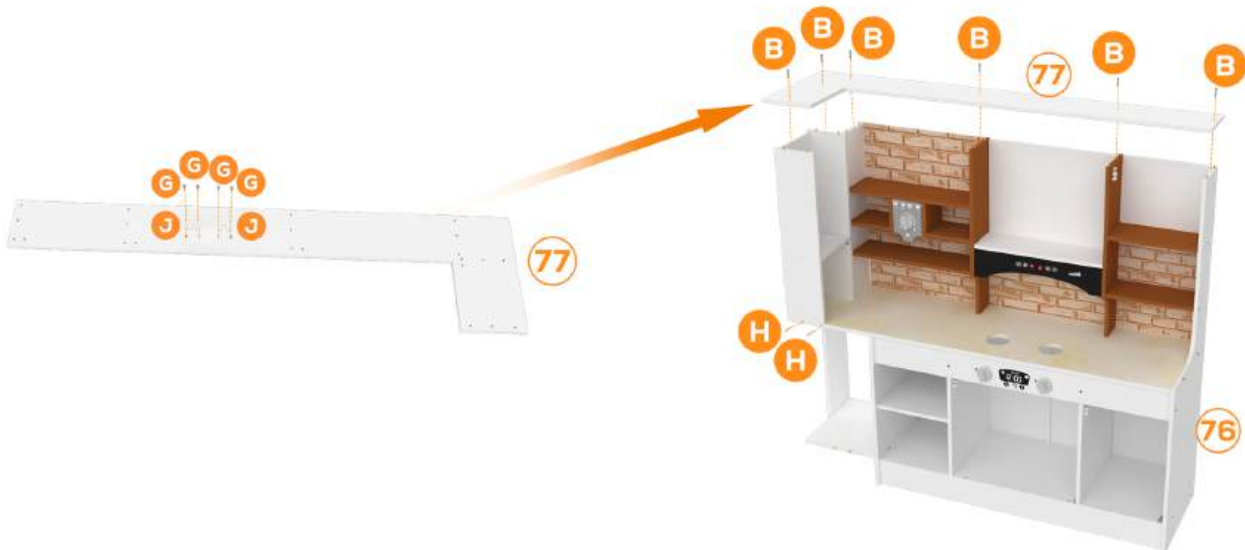

ASSEMBLY INSTRUCTION-BOX A

Step 61 GX14 LX7

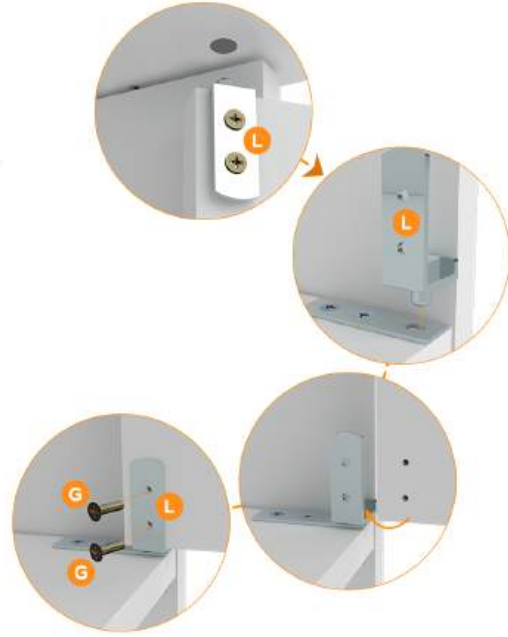

Step 62 BX5 DX2

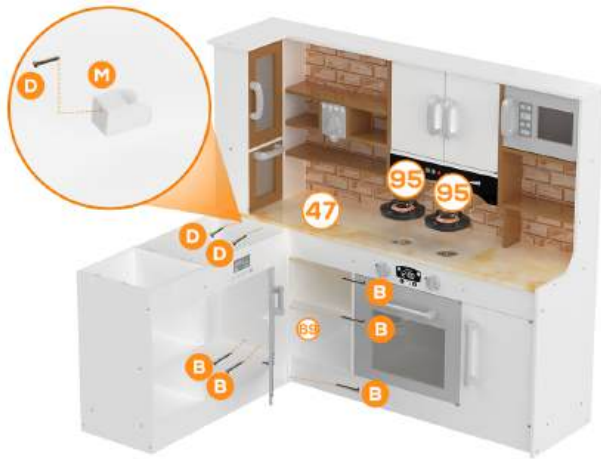

Step 63



Step 64 DX3



Screw #D horizontally into #M

ASSEMBLY INSTRUCTION-BOX A

Step 65 **D**X2 **B**X2



Step 66 **S**X1 **P**X1 **R**X1

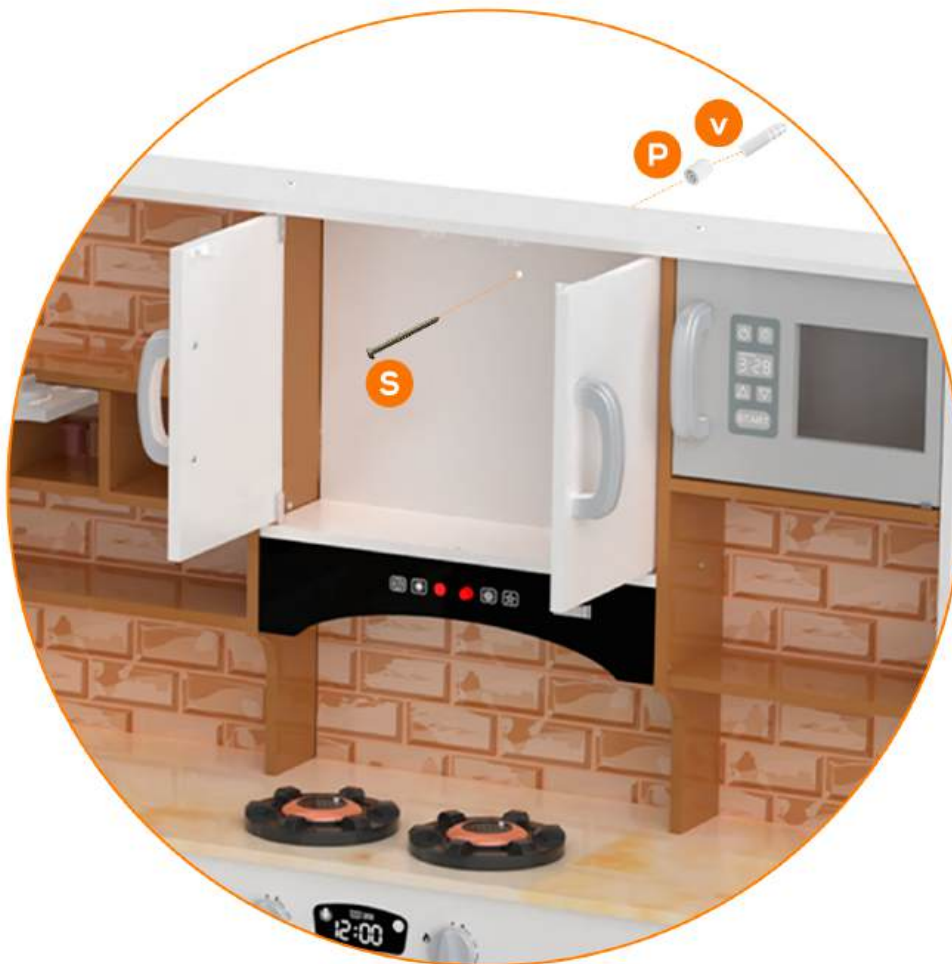

PART AND HARDWARE LIST-BOX B

A 4 X 8MM



6pcs

B 4 X 30MM



45pcs

D 4 X 18MM



10pcs

F 3 X 14MM



2pcs

G 3 X 8MM



37pcs

H



49pcs

J



2pcs

K



2pcs

L



4pcs

M



6pcs

P



1pc

Q



4pcs

R



1pc

S



1pc

T



4pcs

PARTS LIST-BOX B

1



1pc

2



2pcs

3



1pc

4



1pc

5



1pc

6



2pcs

7



1pc

8



1pc

9



1pc

10



2pcs

11



1pc

12



1pc

13



2pcs

14













1pc

15



1pc

PARTS LIST-BOX B

16  1pc	17  1pc	18  1pc	19  1pc	20  1pc
21  1pc	92  4pcs	93  2pcs	99  1set	100  1pc
101  1set				

ASSEMBLY INSTRUCTION-BOX B

Step 1 Hx6 Bx2

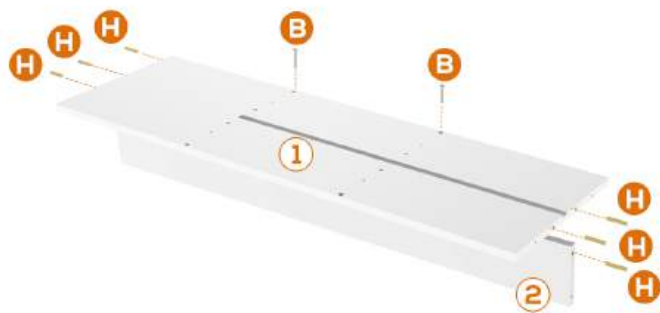

Step 2 Hx2 Bx2

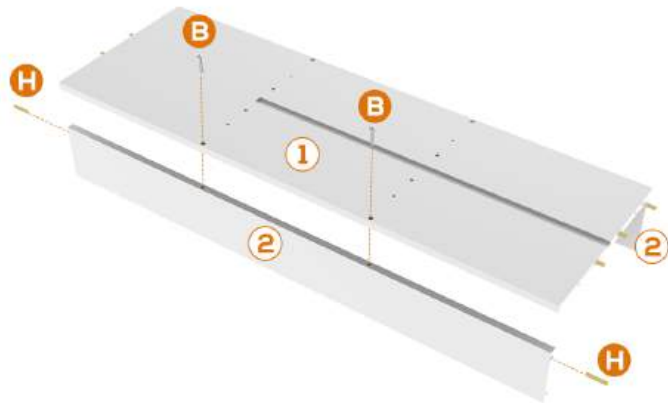

Step 3 Gx4 Tx4

Gx6 Mx6

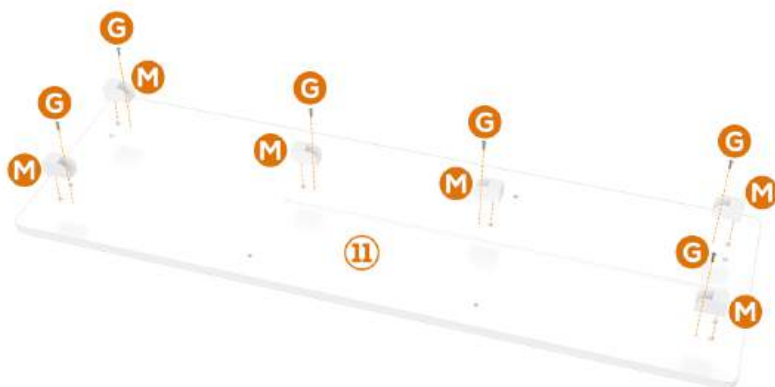
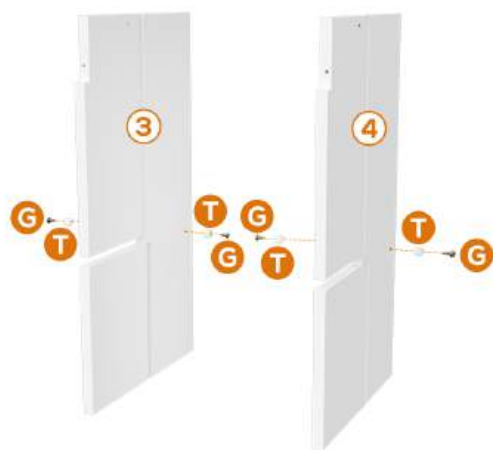

ASSEMBLY INSTRUCTION-BOX B

Step 4 Hx12

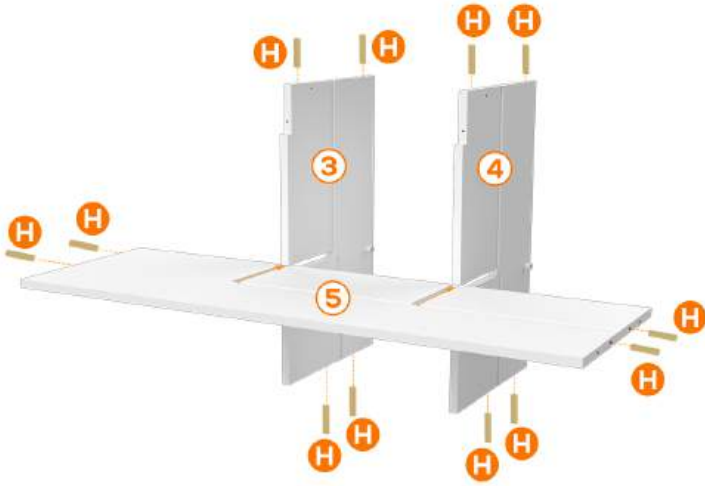

Step 5

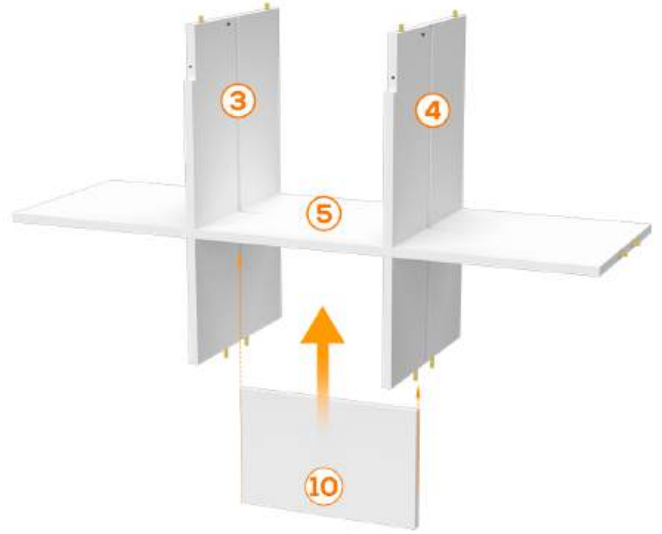

Step 6 Bx4

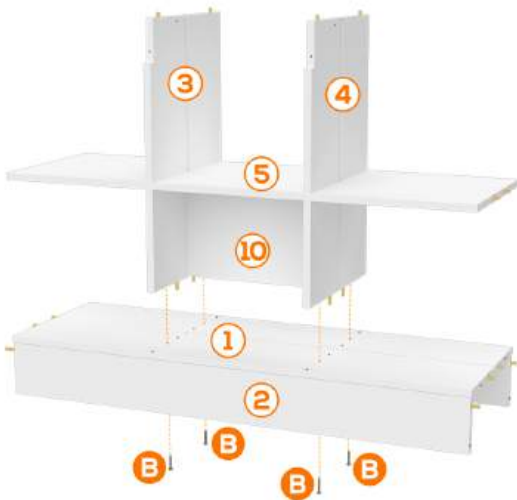

Step 7

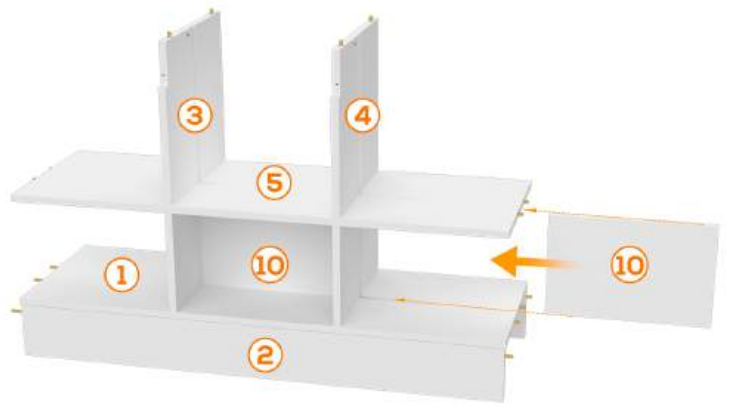

Step 8 Bx6 Hx2

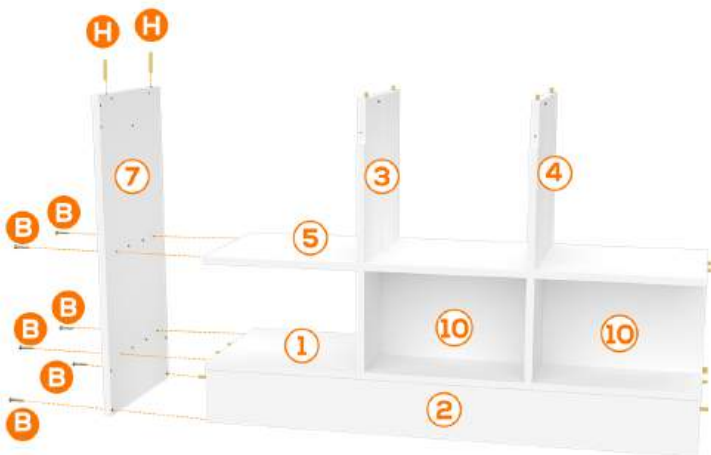

Step 9 Bx2 Hx2

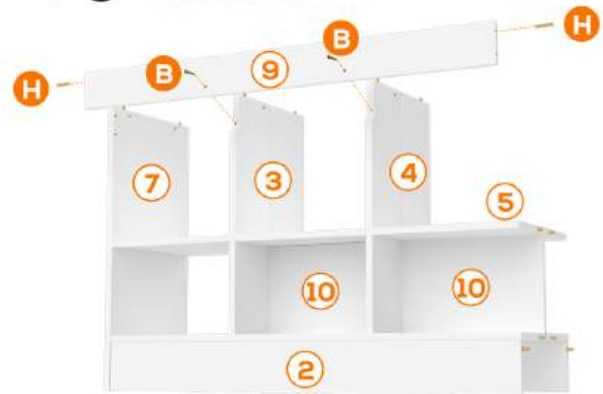

ASSEMBLY INSTRUCTION-BOX B

Step 10 B X8 H X2

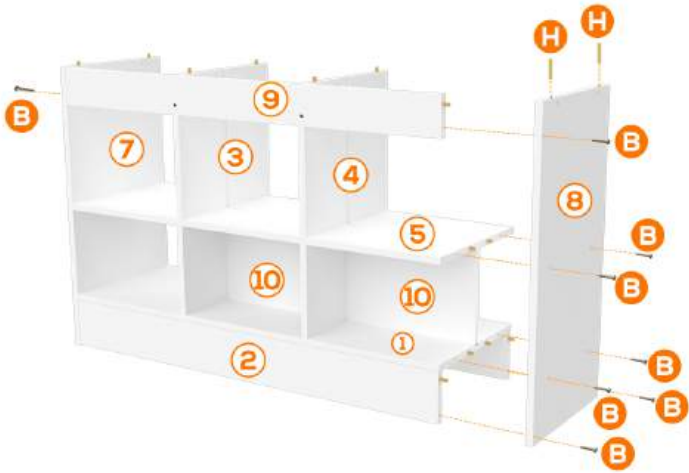

Step 11

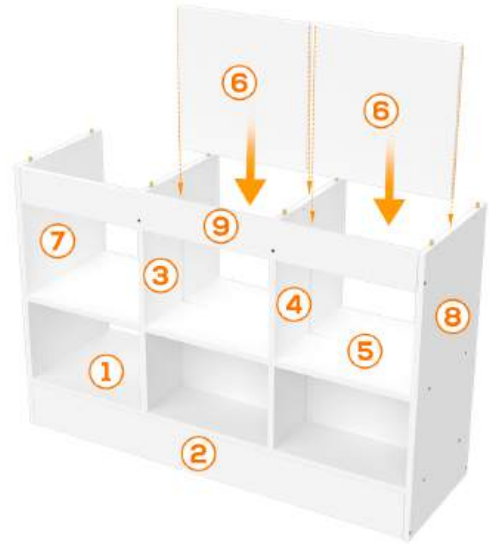

Step 12 D X6



Screw #D horizontally into #M

Step 13 H X8 G X2 Q X1

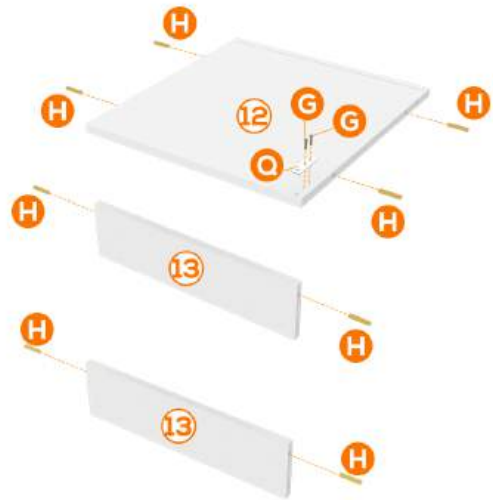

Step 14 G X2 Q X1



Step 15 G X4 L X1 D X2 K X1

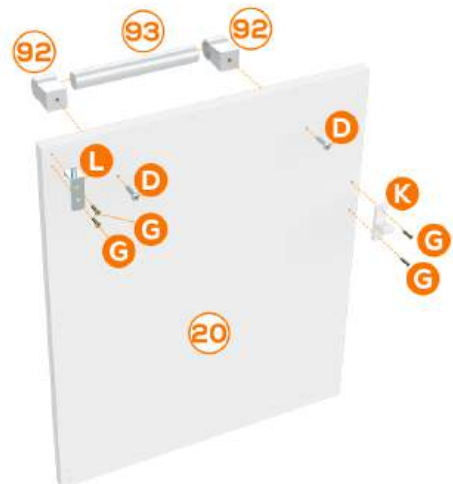

ASSEMBLY INSTRUCTION-BOX B

Step 16 G X4 D X2 L X1 K X1 F X2 A X4

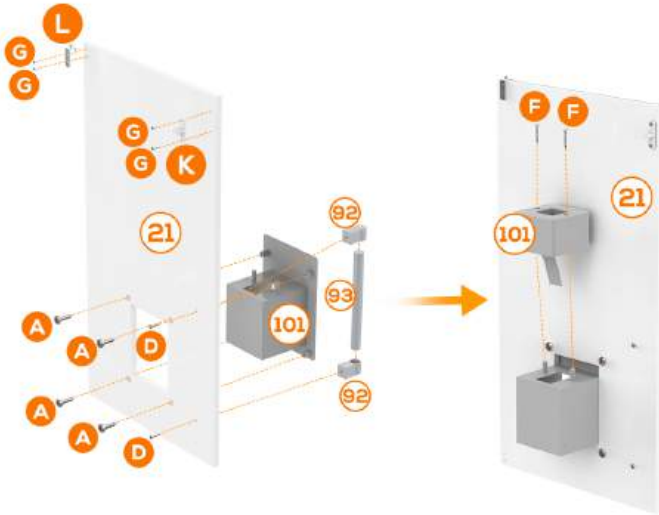

Step 17 H X4 G X4 J X2



Step 18 G X4 H X4 Q X2

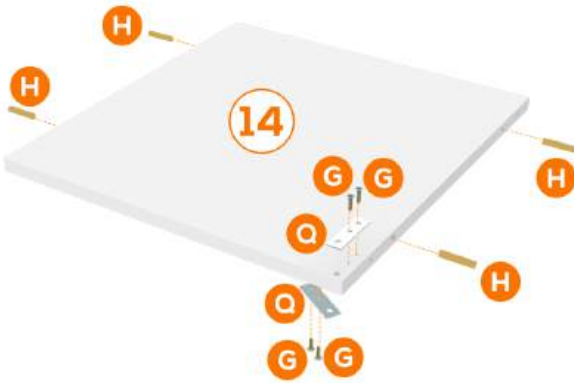

Step 19 H X4

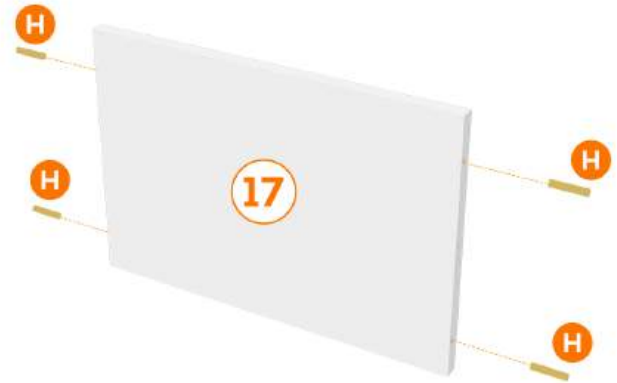

Step 20 B X6

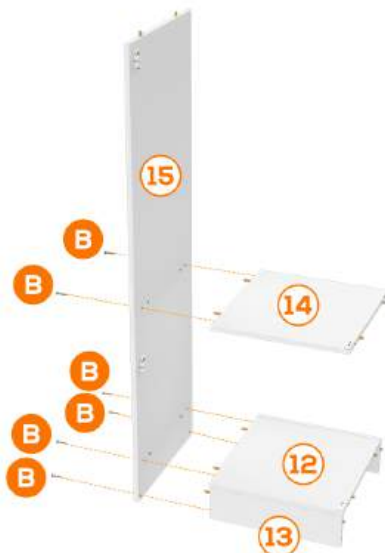

Step 21 B X1

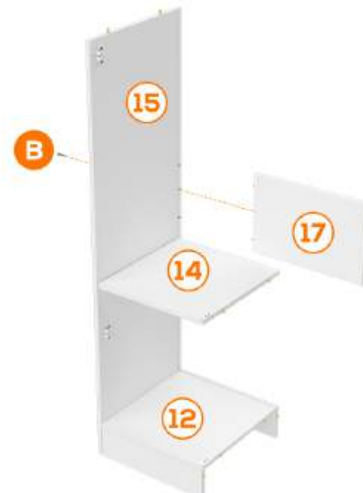

Step 22 B X7

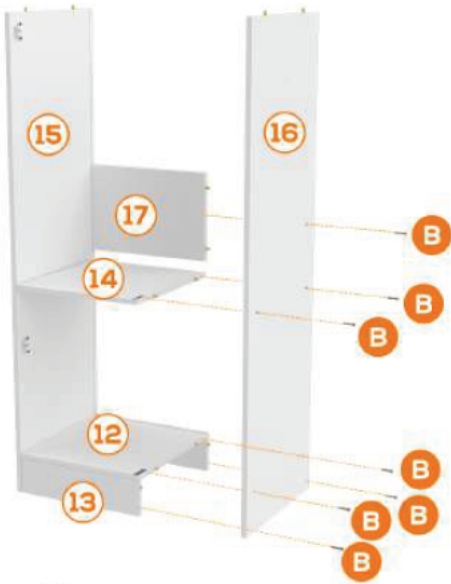

Step 24 B X4



Step 26 A X2



Step 23



Insert #18 all the way down the slot between #14 and #17

Step 25 G X4 L X2



Step 27 P X1 R X1 S X1



Fix the fridge or cabinet to the wall as you like



Please retain this information for future reference

Parental supervision required.

This toy is intended for children of a specific age or above. Parents should supervise the play area so that children younger than the intended age range do not interact with this toy. Use this toy on the floor. Do not allow children to climb on or around or in the toy.

IMPORTANT INFORMATION - PLEASE READ FIRST

All of our wooden items are handcrafted, hand assembled, and hand painted. Each one is unique. Slight imperfections may occur and are not manufacturing defects.

CLEANING INSTRUCTIONS

Clean the surface using a slightly damp cloth and mild dish washing liquid if necessary. Do not use any cleaning product containing alcohol or ammonia. These will dull the shiny surface of the product. Furniture polish will also work to clean and dust off the surface.

We recommend that you test all cleaning materials on the underside of any surface. That would not be seen during normal use of the product. If you have questions regarding the maintenance of this product please feel free to call us.

SOLE AND LIMITED WARRANTY

This toy is warranted solely against manufacturing defects for a period of 90 days from the date of purchase, which warranty runs only to the original user of the toy. In the event of a manufacturing defect, the toy will be replaced or the purchase price refunded, at the election of the manufacturer. To activate and protect this warranty, preserve evidence of original purchase and carefully inspect the condition of the toy prior to and after assembly, looking for missing, degraded, broken or hazardous parts, including parts which can be swallowed by a child, cause a child to choke, or otherwise cause injury. Such parts may include magnets, wheels, hubs, fasteners, and connectors. Should you observe any defects, do not use the toy and immediately notify the manufacturer. Failure to do so shall constitute misuse. Misuse, improper assembly, failure to honor a warning, failure to supervise, inspect or maintain the toy, or damage to the toy, whether intentional or inadvertent, shall invalidate this warranty.

To submit a warranty claim please contact BRINJOY customer service for instructions on how to provide proof of purchase and how to return the item freight pre-paid.