

Door Leaf Assembly Guide Installation Manual

Bifold 03 Collection



Assembly reference only.
The quantity of plank ② may vary based on door width.

Side View

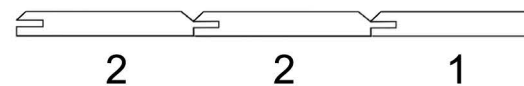
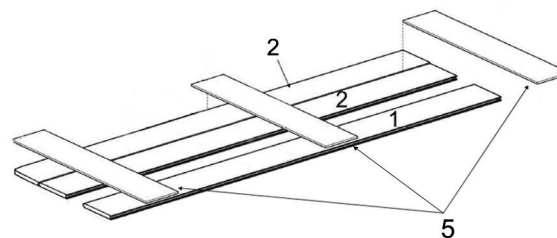
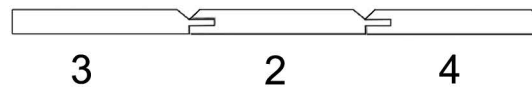
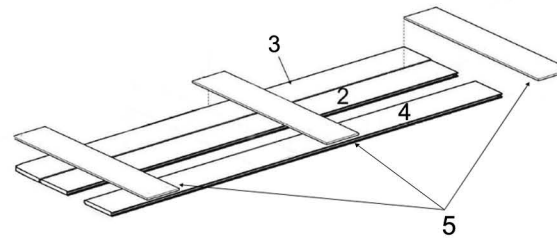
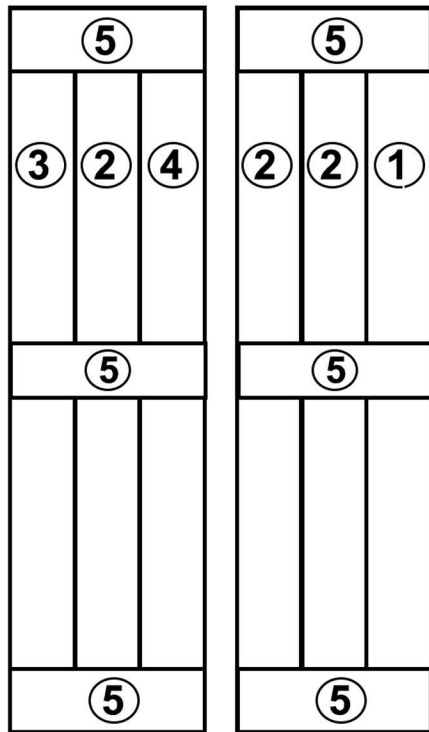
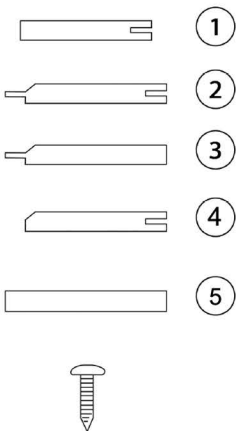

1

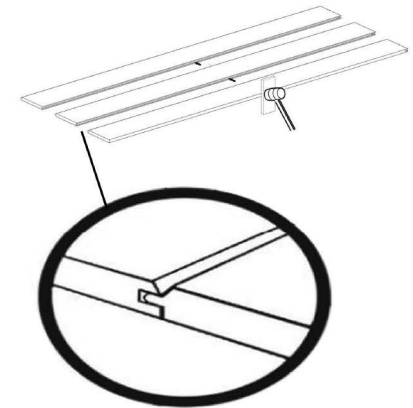

2

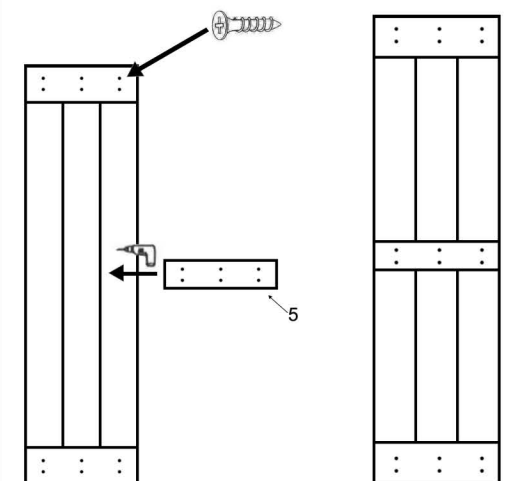

The pre-drilled holes need to be positioned in the center of the bottom panel to ensure both structural stability and aesthetic balance for the door.