

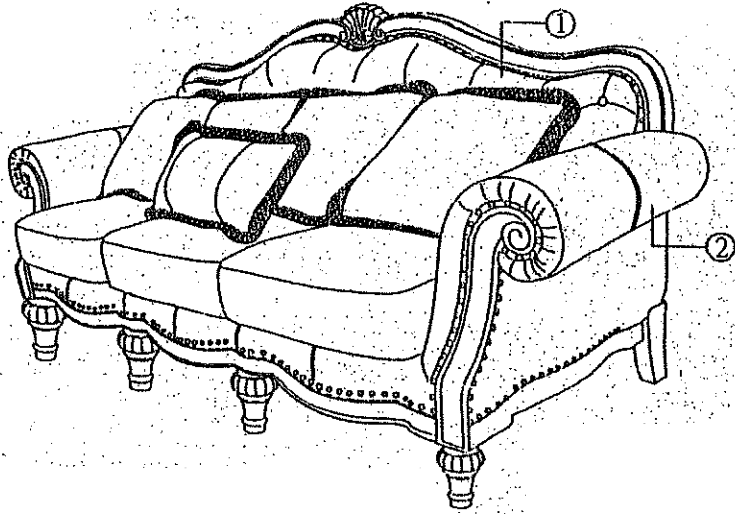



SOFA ASSEMBLY INSTRUCTION

Thank you for purchasing this quality product!



HARDWARE LIST :

A		φ22mm×φ5/16"	10PCS
B		φ5/16"	10PCS
C		φ5/16"×3 1/2"	7PCS

PARTS LIST :

E	①	Sofa Back	1PCS
F	②	Sofa Seat with Arm	1PCS

STEP 1 :
Attach the sofa back to the seat frame.

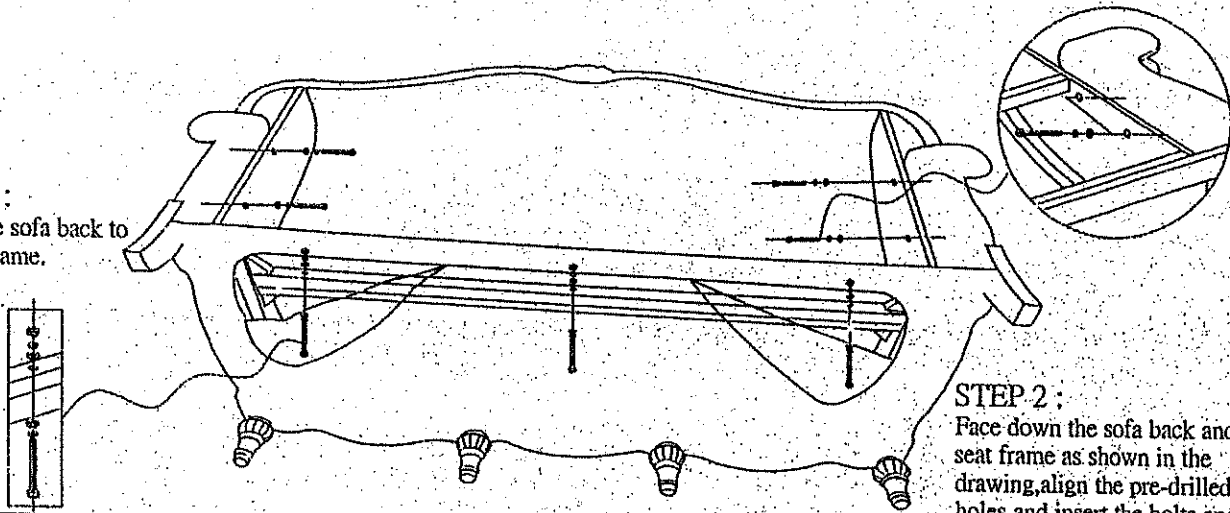

STEP 2 :
Face down the sofa back and seat frame as shown in the drawing, align the pre-drilled holes and insert the bolts and washer then tighten it, please make sure the bolts are all tightened in proper position.

STEP 3 :
Upright the sofa, check the stability the item, assembly is completed.

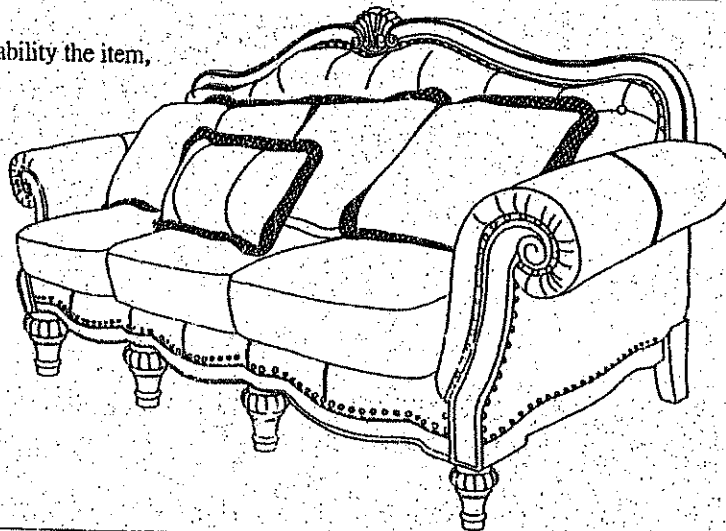



SOFA ASSEMBLY INSTRUCTIONS

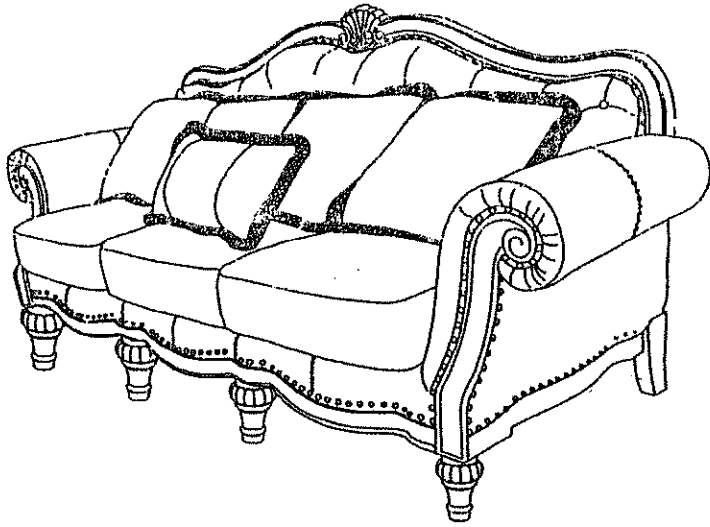

Thank you for purchasing this quality product!



HARDWARE LIST :

A		ø22mmxø5/16"	4PCS
B		ø5/16"	4PCS
C		ø5/16"x3 1/2"	4PCS

PARTS LIST :

D		4PCS
E		2PCS

