

VEVOR[®]

TOUGH TOOLS, HALF PRICE

Technical Support and E-Warranty Certificate www.vevor.com/support

BUBBLE-TENT USER MANUAL

We continue to be committed to provide you tools with competitive price.

"Save Half", "Half Price" or any other similar expressions used by us only represents an estimate of savings you might benefit from buying certain tools with us compared to the major top brands and does not necessarily mean to cover all categories of tools offered by us. You are kindly reminded to verify carefully when you are placing an order with us if you are actually saving half in comparison with the top major brands.

VEVOR®

TOUGH TOOLS, HALF PRICE

BUBBLE-TENT

Model: 120972, 120973, 120974

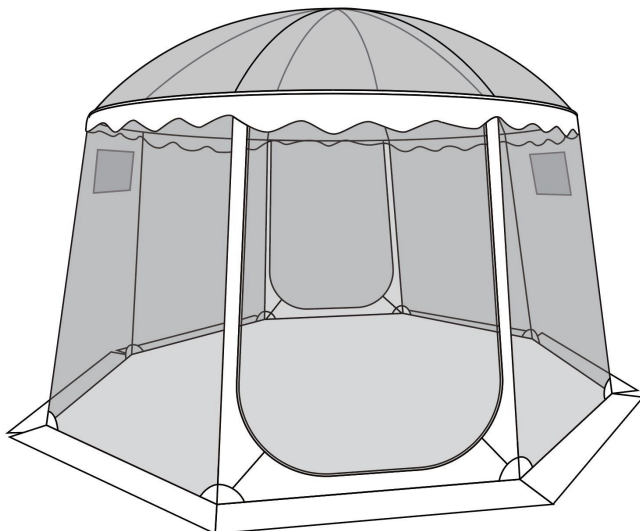

NEED HELP? CONTACT US!

Have product questions? Need technical support? Please feel free to contact us:

Technical Support and E-Warranty Certificate
www.vevor.com/support

This is the original instruction, please read all manual instructions carefully before operating. VEVOR reserves a clear interpretation of our user manual. The appearance of the product shall be subject to the product you received. Please forgive us that we won't inform you again if there are any technology or software updates on our product.

ASSEMBLY AND SAFETY INSTRUCTIONS

Please pay close attention to the following instructions in order to reduce the risk of injuries, accidents or damage to the product by itself.

IMPORTANT

Please follow ALL safety instructions listed below.

Please remove the packaging material before assembling or using the product.

Please make sure that all listed parts are included in the package and that they are not damaged.

Please read these assembly and safety instructions carefully before usage of the tent and keep them for future reference.

This product should only be used in a non-commercial way.

SAFETY INFORMATION

The tent was not tested for wind and snow loads, unless that is clearly indicated otherwise. Therefore, these loads are not covered by guarantee. Please watch the weather forecasts to be able to properly protect or disassemble the tent before problems appear. Tents should only be used as temporary accommodation and should be disassembled in adverse weather conditions.

Make sure to keep sufficient distance to houses as well as gas and power lines to avoid possible damage. Please check the area for power cables and gas lines. Ask your local authority for further information if needed.

When making use of suitable heaters, keep a minimum distance from 1.2 m to tarp material. Open fire or heaters with open flames such as patio heaters, umbrella heaters, gas heaters etc. should NOT be used inside the tent in any case.

SPECIFICATIONS

Model	1209702
Product Size	10×10ft
Color	Transparent

Model	120973
Product Size	12×12ft
Color	Transparent

Model	120974
Product Size	15×15ft
Color	Transparent

Components

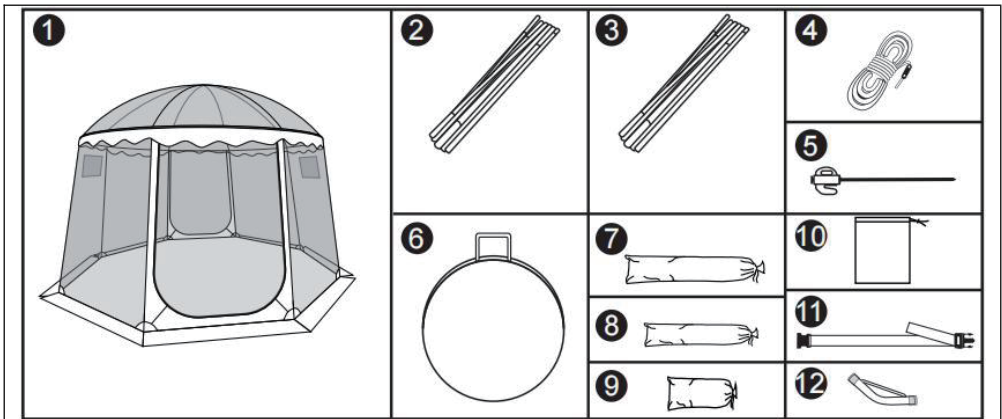

- 1. Tent *1
- 2. Fiber rod A*4
- 3. Fiber rod B*8
- 4. Camp rope *8
- 5. Camp nail *16
- 6. Carrying Bag *1

- 7. Pole Bag A*1
- 8. Pole Bag B*1
- 9. Pegs & Ropes Bag *1
- 10. Sandbag *4 (Model:1209702, 120973)
Sandbag *8 (Model:1209704)
- 11. Tying rope*1
- 12. metal L-bend *8

Please read, understand, and practice the guidelines in this user manual before use, and keep it for future reference.

Assembly instructions:

01

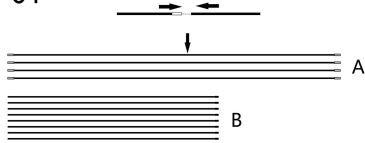

02

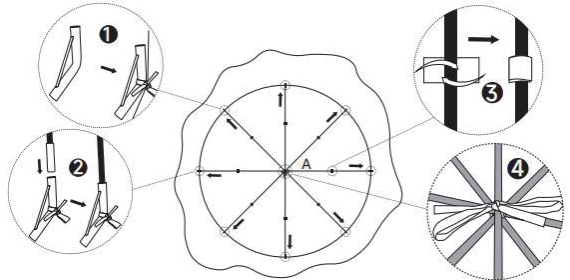

Assemble two sets of fiber rods, 4 long rods A and 8 short rods B.

12. metal L-bend *8

Lay the tent flat on the ground, with 8 metal L-bends facing upwards. ①: Thread the 8 metal L-bends through the ropes and tie them tightly.;

②: Four A-poles are placed cross at a 45 degree angle next to the metal passage, and the two ends of the poles are threaded into the metal passage in order;

③: Fix the pole with Velcro on the tent;

④: Tie the four poles tightly with straps at the intersection in the middle.

03

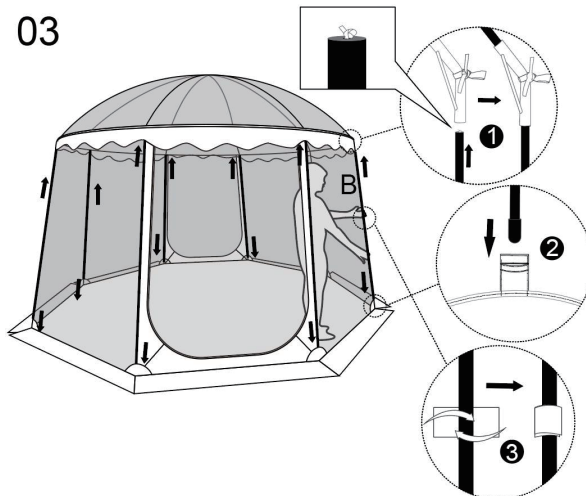

Two people work together to flip the top of the tent over and tidy up the sides of the tent.①:1 person is supporting the tent outside, and 1 person is inside putting the rubber free cap end of the B pole Thread into the metal L-junction;②:The rubber cap is threaded into a white pocket at the bottom;③:Fix the middle position with Velcro.

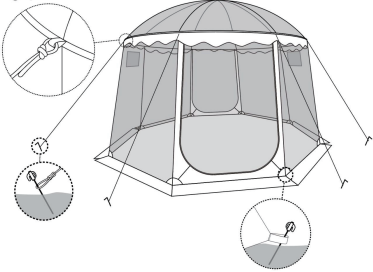
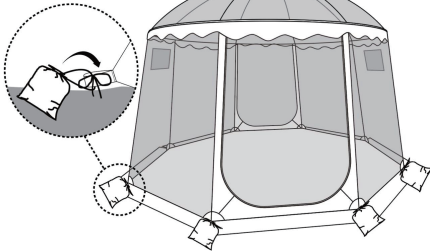
<p>04</p> 	<p>05</p> 
<p>Tie the camp rope, fix the tent corner and camp rope with ground nails, and complete the construction.</p>	<p>In cases where the ground nails cannot be used, the matching sandbags can be filled with sand, Tie stones or other heavy objects to the bottom corner of the tent for fixing purposes.</p>

Storage instructions:

(Note: Snow layer cannot accumulate on the top of the product, please clean or put it away in a timely manner)

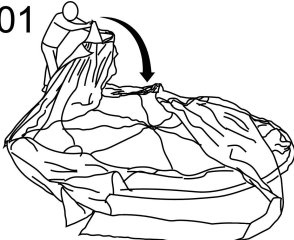
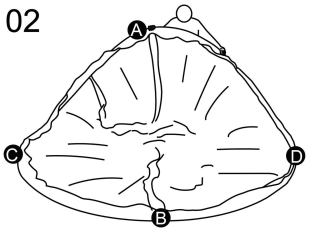
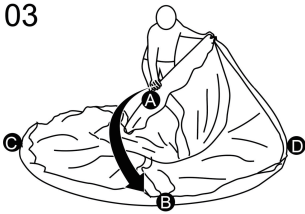
<p>01</p> 	<p>02</p> 	<p>03</p> 
<p>Remove the ground nails, camping ropes, support rods and other accessories that secure the tent, and then Flip the tent over and lay it flat on the ground.</p>	<p>After organizing, the tent forms a circle.</p>	<p>Twist point A to point B, coinciding with point B.</p>

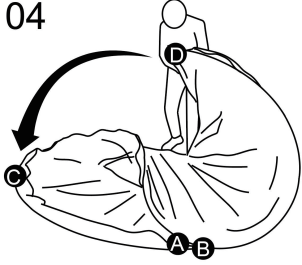
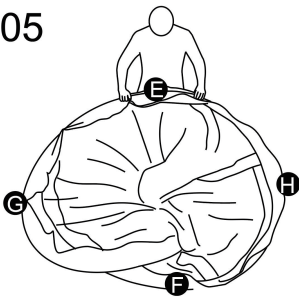
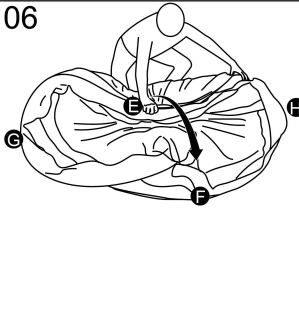
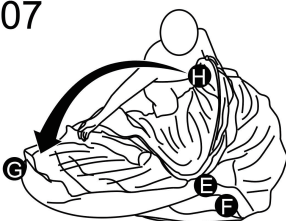
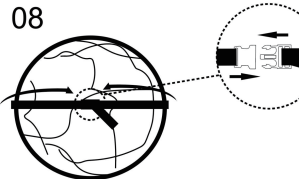
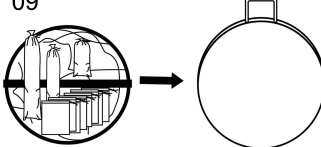
<p>Arrange the tent fabric in the middle of the circle.</p>		
<p>04</p> 	<p>05</p> 	<p>06</p> 
<p>Then move point D closer to point C until it overlaps and folds into two layers of circles.</p>	<p>Grasp the 2-layer circular rod and repeat step 3/4.</p>	<p>Twist point E to point F, coinciding with point F.</p>
<p>07</p> 	<p>08</p> 	<p>09</p> 
<p>Then move the H-point closer to the G-point until it overlaps and folds into a 4-layer circle.</p>	<p>Organize the circular body and adjust the four layers to the same size, so that the folded tent is adjusted to be close to a full circle. Then, tie it tightly with a strap with a buckle.</p>	<p>Finally, put the tent and accessories all into the handbag and complete the storage process.</p>

Precautions for use:

- 1: Try to build it in a sheltered location. If the wind is above level 4, need to remove the fiber poles on the side to reduce the height, and reduce the damage to the product caused by strong winds.
- 2: Avoid contact with sharp objects during set up and use.
- 3: Cannot withstand the pressure of heavy snow; surface ice can only melt naturally, manual de-icing will form sharp ice blocks that will pierce the tent.

Manufacturer:Shanghaimuxinmuyeyouxiangongsi

Address: Shuangchenglu 803nong11hao1602A-1609shi, baoshanqu, shanghai 200000 CN.

Imported to AUS: SIHAO PTY LTD. 1 ROKEVA STREETEASTWOOD NSW 2122 Australia

Imported to USA: Sanven Technology Ltd. Suite 250, 9166 Anaheim Place, Rancho Cucamonga, CA 91730

EC	REP
-----------	------------

E-CrossStu GmbH
Mainzer Landstr.69, 60329 Frankfurt am Main.

UK	REP
-----------	------------

YH CONSULTING LIMITED.
C/O YH Consulting Limited Office 147, Centurion House,
London Road, Staines-upon-Thames, Surrey, TW18 4AX

VEVOR[®]

TOUGH TOOLS, HALF PRICE

Technical Support and E-Warranty Certificate

www.vevor.com/support