

Assembly Manual

OFFICE CHAIR

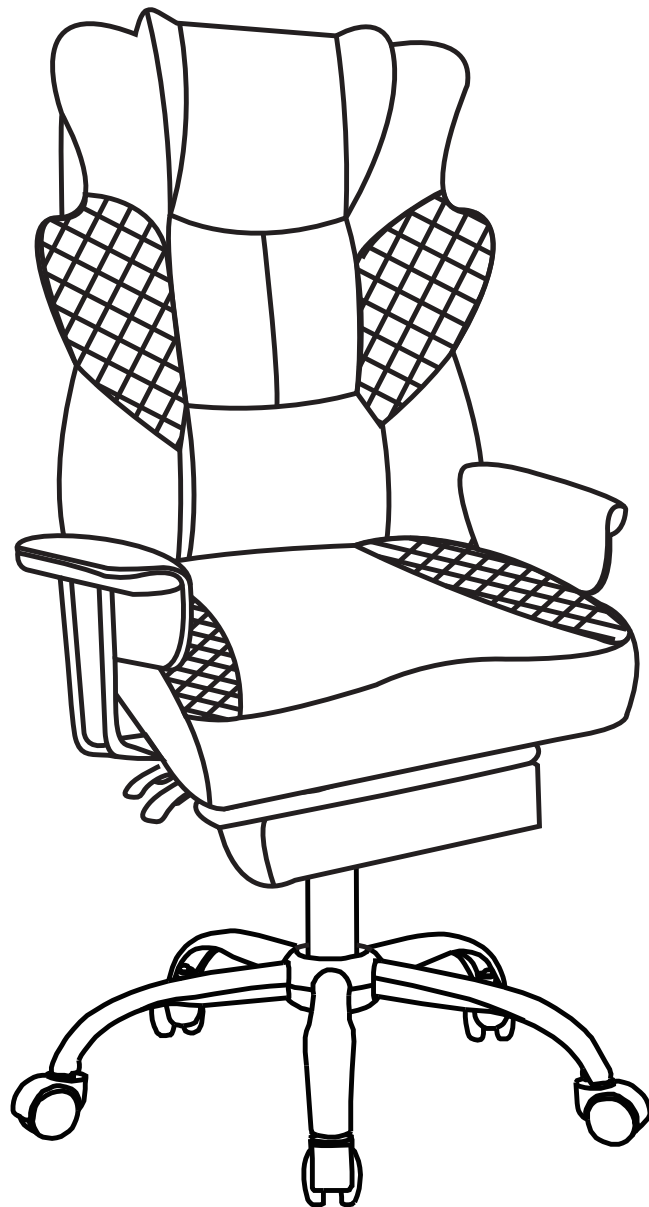

Please read this manual carefully before any operation and keep it properly for future use.

Matters Needed Attention for Chair

Thank you for the recent purchase of our product. We hope you will be pleased with both the product and service you received. If not, please give our helpful customer service team an opportunity to improve your experience right away.

1. Installation Troubleshoot

- The parts are missing/damaged in transportation, contact us to get replacement part.
- The screws can not insert or the slots for the screw is stripped, contact us to get help.

2. Usage Troubleshoot

- Adjust the height of the chair to suit your height. If it is not suitable for you, please contact us for help.
- The armrests, footrests, and backrest are all adjustable. If these adjustments do not meet your needs, please contact us for help.
- If the chair is tilted to one side or forward, make sure the screws on the seat plate are tightened, make sure the chassis is not mounted upside down, and contact us if the problem cannot be resolved.

- If the fabric of the chair is torn or stained when you receive it, please contact us to get the replacement part or compensation.
- If the chassis is broken, please contact us for a replacement or partial refund, please contact us for help.
- If part is missing, please contact us and provide the picture of the missing part, we will replace it

3. Return Request

If you are not 100% satisfied with the chair, please give us a chance to help you solve all your problems with our products

And we also need your suggestions to improve the quality of the chairs to avoid the same problems happening again, this is the most important thing we can do as a new brand.

Instruction for Use



Upward Adjustment

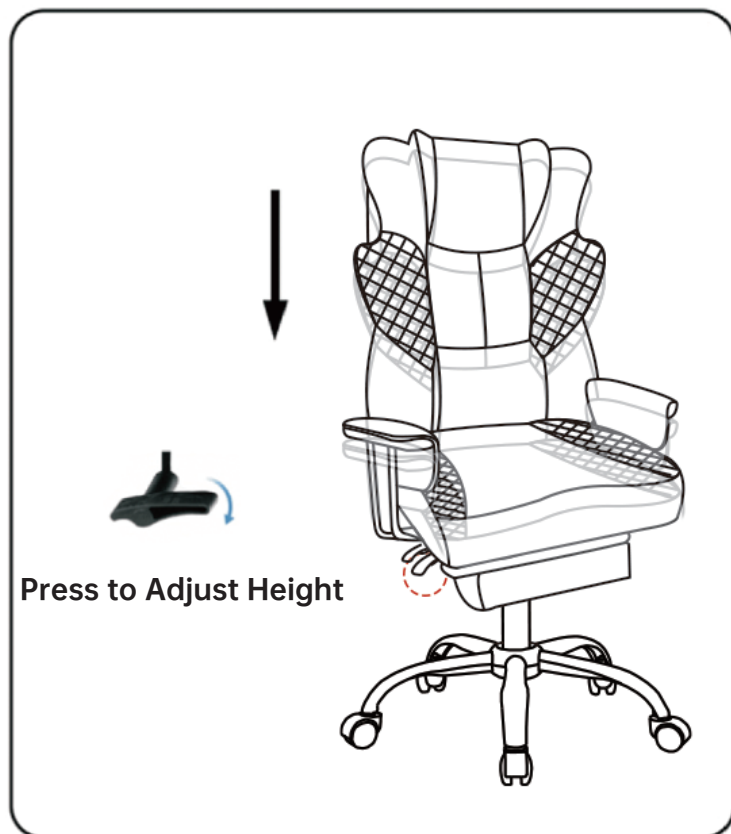

Downward Adjustment





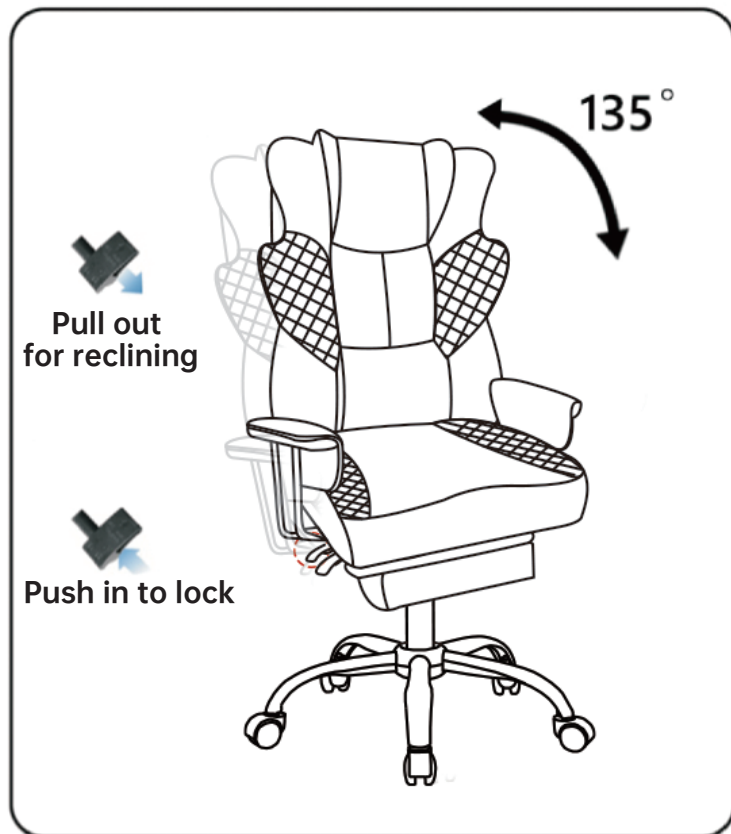



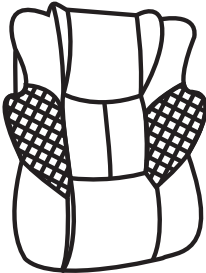
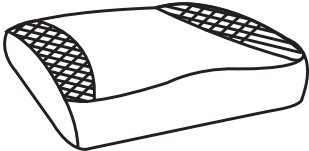

Retractable Footrest

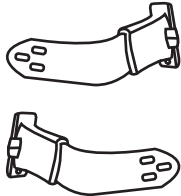
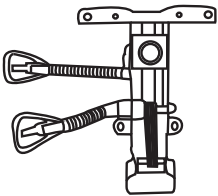

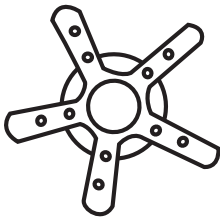
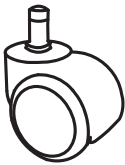
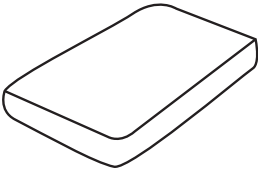
Reclining Function

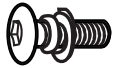
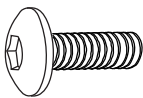
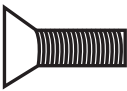
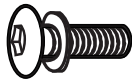
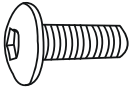
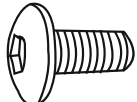
Accessories List

<p>(1) Backrest</p> 	<p>(2) Seat Cushion</p> 	<p>(3) Armrest Pad</p> 	<p>(4) Armrest Frame</p> 
<p>(5) Base Plate</p> 	<p>(6) Air Rod</p> 	<p>(7) Split Base Tube x5</p> 	<p>(8) Central Base Tube</p> 
<p>(9) Castor x5</p> 	<p>(10) Footrest</p> 	<p>(11) Steel Plate</p> 	<p>(12) Screws M6x20 mm x10</p> 
<p>(14) Screws M6x30 mm x4</p> 	<p>(15) Screws M6x25 mm x4</p> 	<p>(16) Screws M8x20 mm x4</p> 	<p>(13) Screws M6x25 mm x8</p> 
			<p>(17) Screws M6x20 mm x4</p>  <p>(18) Hexagon Wrench</p> 

Assembly Instruction

STEP 1

Insert Split Base Tube into Central Base Tube

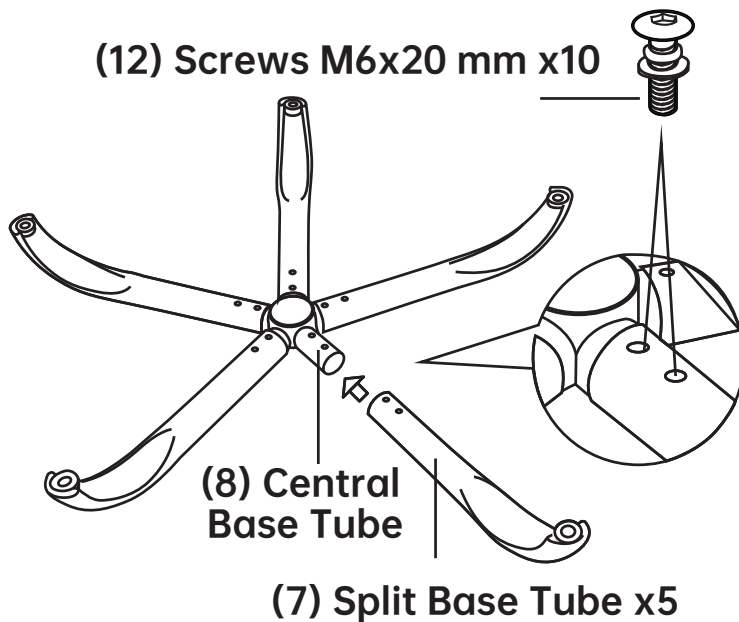

STEP 2

Insert Castors and Air Rod into parts done in Step 1

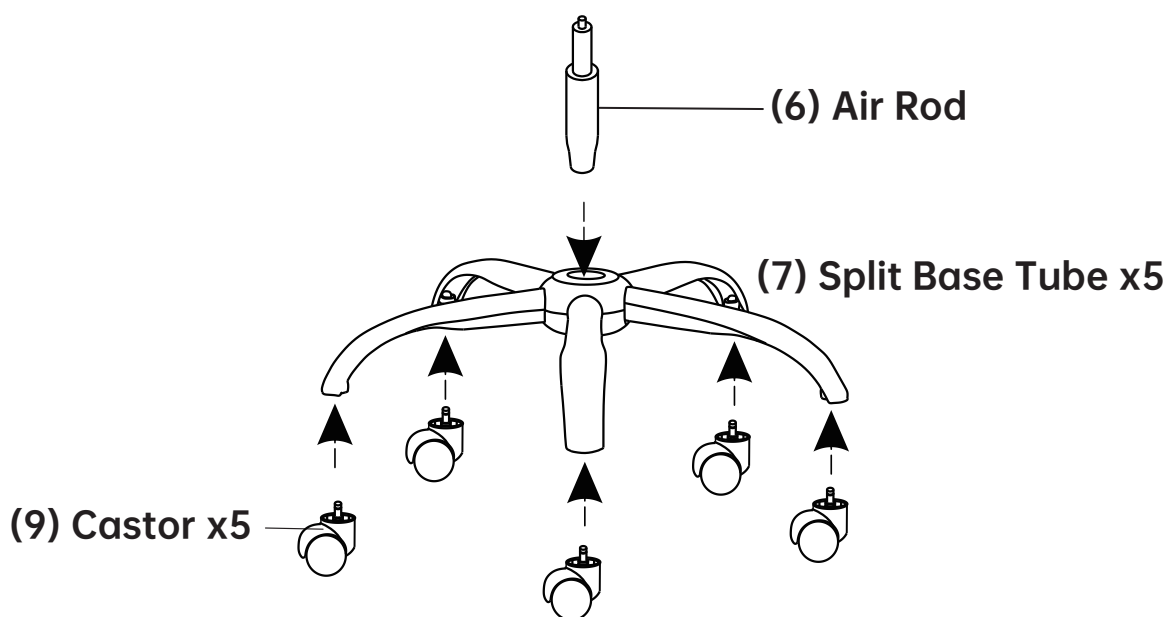

Assembly Instruction

STEP 3

Assemble the Armrests

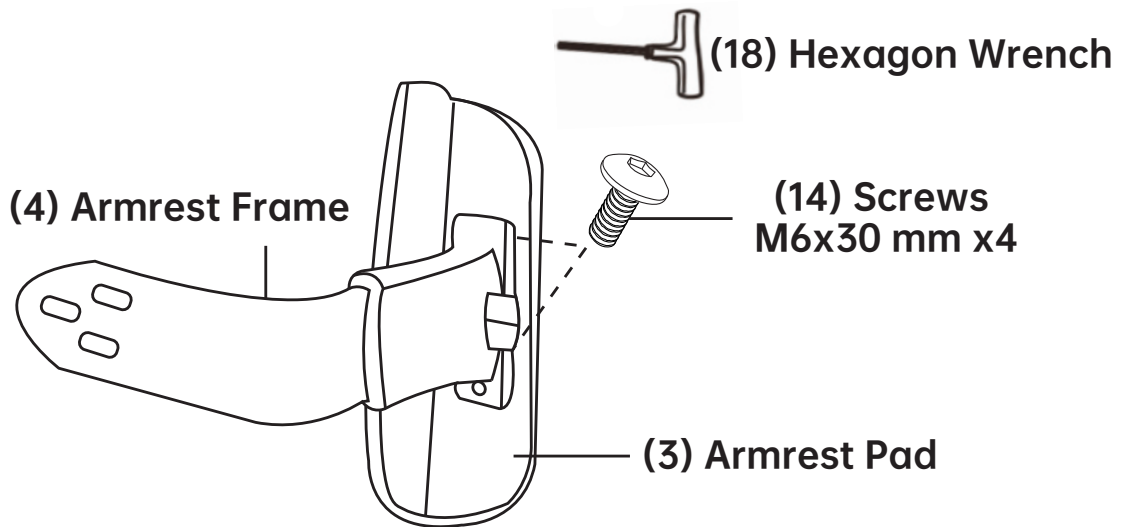

STEP 4

Assemble the Footrest and Attach the Base Plate and Armrests on the Seat Cushion

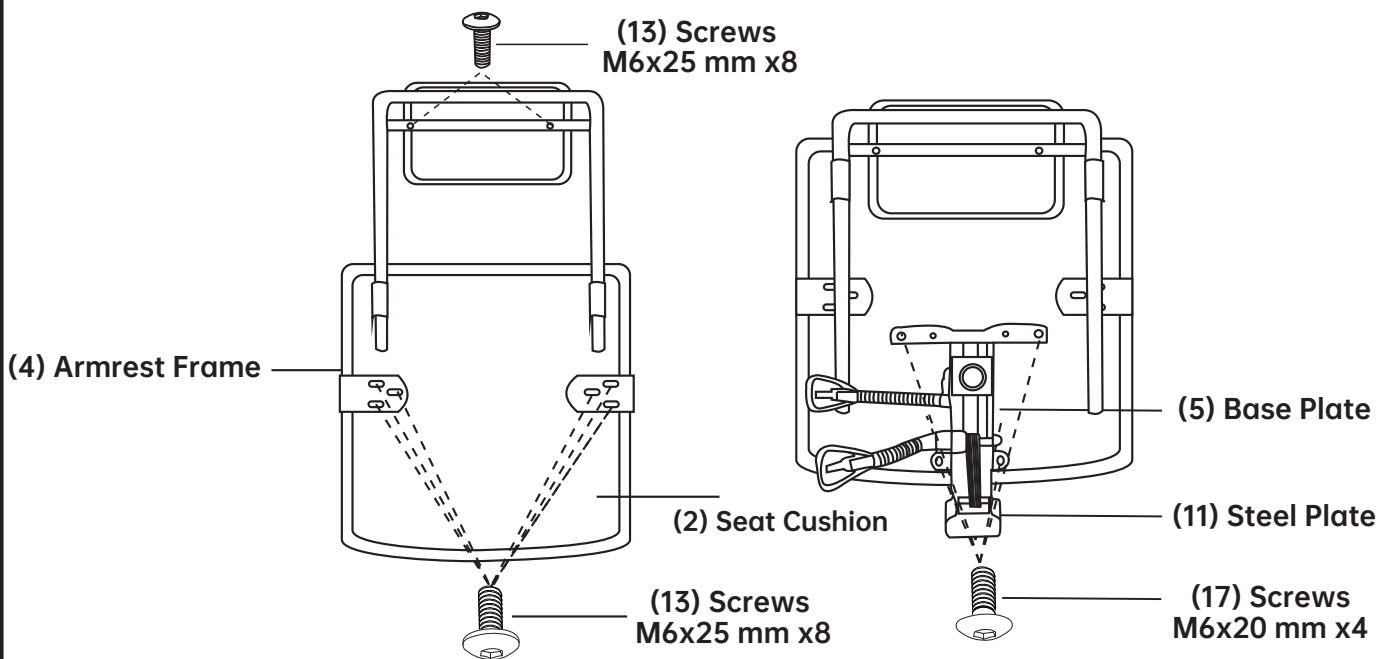

Assembly Instruction

STEP 5

Insert the Air Rod into the Base Plate
Then Assemble the Backrest

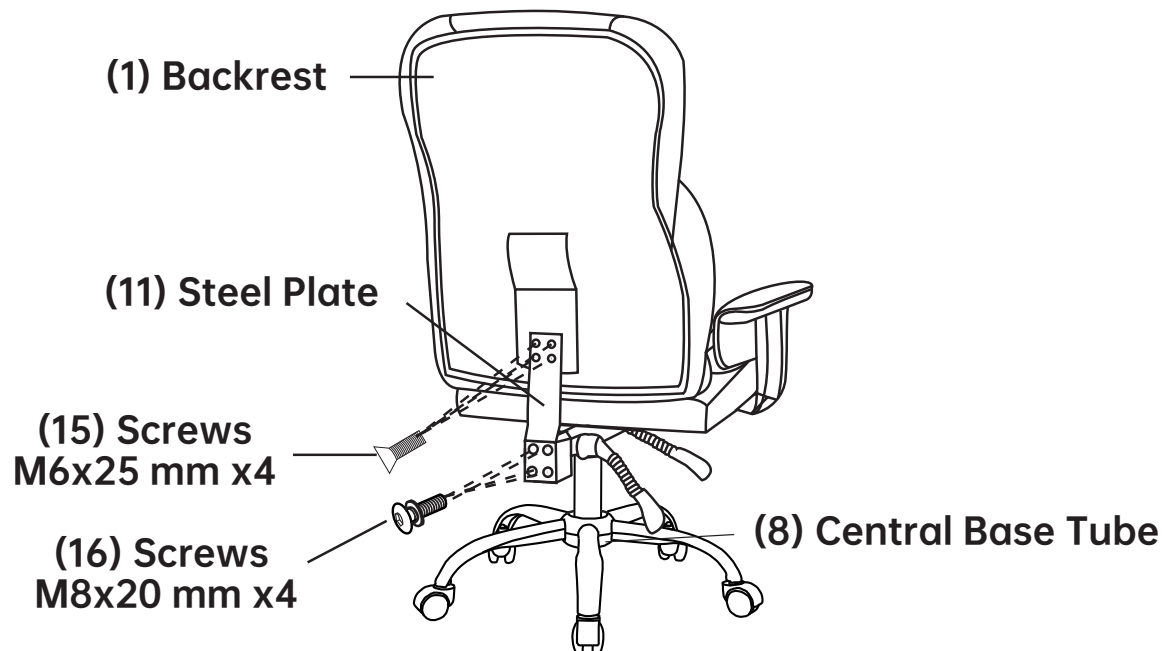

STEP 6

The assembly is complete now.

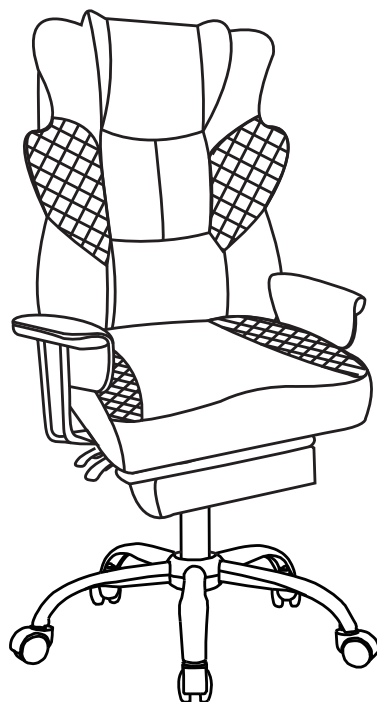

Matters Needed Attention for Chair

Thank you for the recent purchase of our product. We hope you will be pleased with both the product and service you received. If not, please give our helpful customer service team an opportunity to improve your experience right away.

Installation Troubleshoot

- The parts are missing/damaged in transportation, contact us to get replacement part.
- The screws can not insert or the slots for the screw is stripped, contact us to get help.

Chair Safety Warnings

1. General Safety Warnings

- "This chair is designed for office or home use only. Do not use it for industrial, medical, or other unintended purposes."
 - "Maximum weight capacity: 500lbs. Exceeding this limit may cause structural failure and injury."
-

2. Assembly Warnings

- "Follow the assembly instructions precisely. Incorrect assembly may lead to instability or collapse."
 - "Ensure all screws and bolts are fully tightened before use. Check periodically for looseness."
-

3. Usage Warnings

- "Do not stand on the chair or use it as a step ladder. The chair is not designed to support dynamic loads."
 - "Avoid leaning back excessively or rocking the chair violently, as this may cause tipping."
-

4. Adjustment Warnings

- "Adjust the seat height so your feet rest flat on the floor. Improper adjustment may cause posture-related injuries."
-

5. Maintenance Warnings

- "Use only mild cleaners. Harsh chemicals may damage materials or weaken structural integrity."
 - "Inspect the chair regularly for wear and tear (e.g., armrests, footrest and backrest). Replace damaged parts immediately."
-