

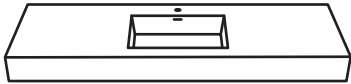

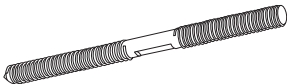

# PRODUCT ASSEMBLY INSTRUCTIONS

[ Product Model: FS169-1524 ]

## List :

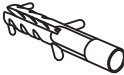
					
Solid Surface Bathroom Sink x1	Fastener x6	Gaskets x6	Nut x6	Expansion sleeve x6	

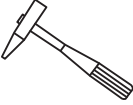
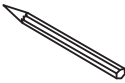
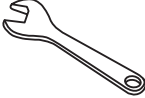
## Tools Required :

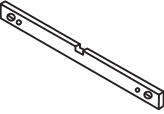
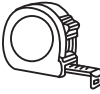
						
Hammer	Pencil	Wrench	Electrodrill	Gradienter	Steel tape	

### Installation steps : 1

Measure the distance of the mounting holes, and the height you want, mark with the pencil.  
(33"-36" is preferred for countertop height).

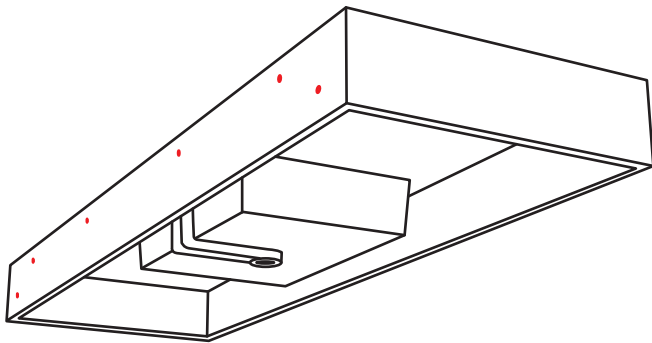

[ The back of the product ]

### Installation steps : 2

Drill the hole at the mark with electric drill.

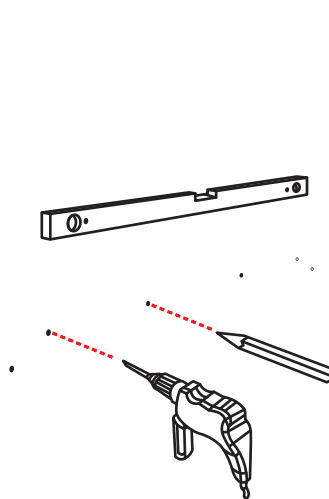

### Installation steps : 3

Install the expansion sleeve first, then the screws.  
**⚠** Make sure the screws are securely installed.

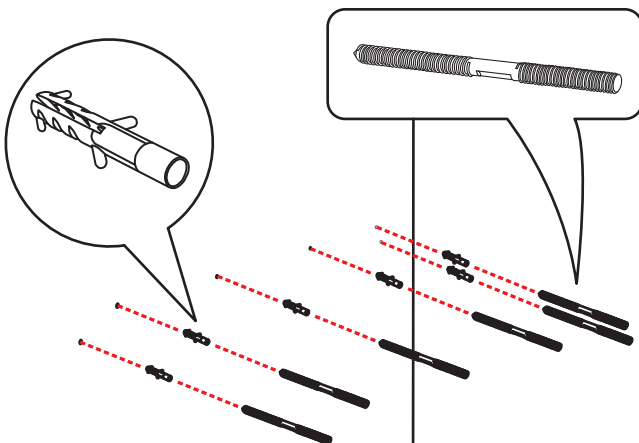

### Installation steps : 4

Hold the basin and use a spanner to lock the basin to the wall.

