

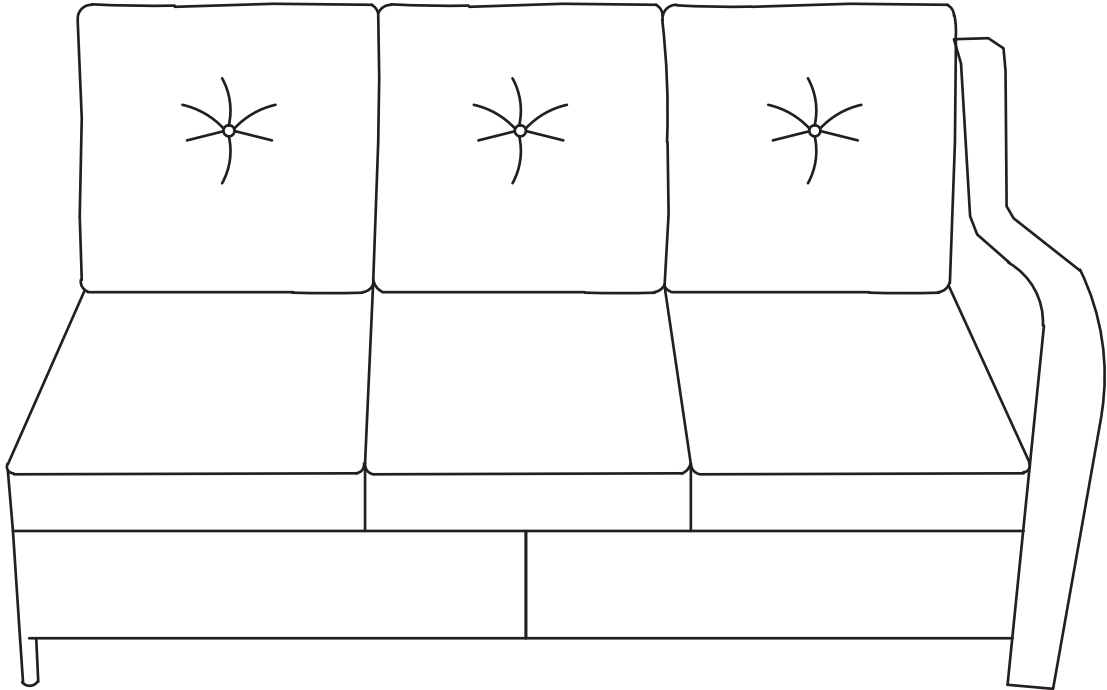









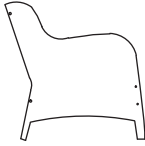
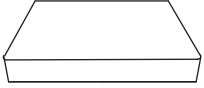
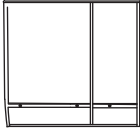
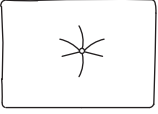
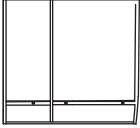

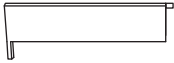
Assembly Instructions

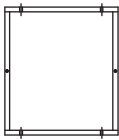

***Don't fully tighten all the bolts till the very end!**

PRE-ASSEMBLY PREPARATION:

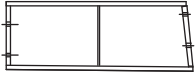
- Please read through the instructions before beginning assembly.
- Clear out the space for assembly and lay out all of the parts based on the Parts List, extra room will allow you to easily determine if all the pieces are present.
- Keep small parts and pieces away from children until fully assembled.

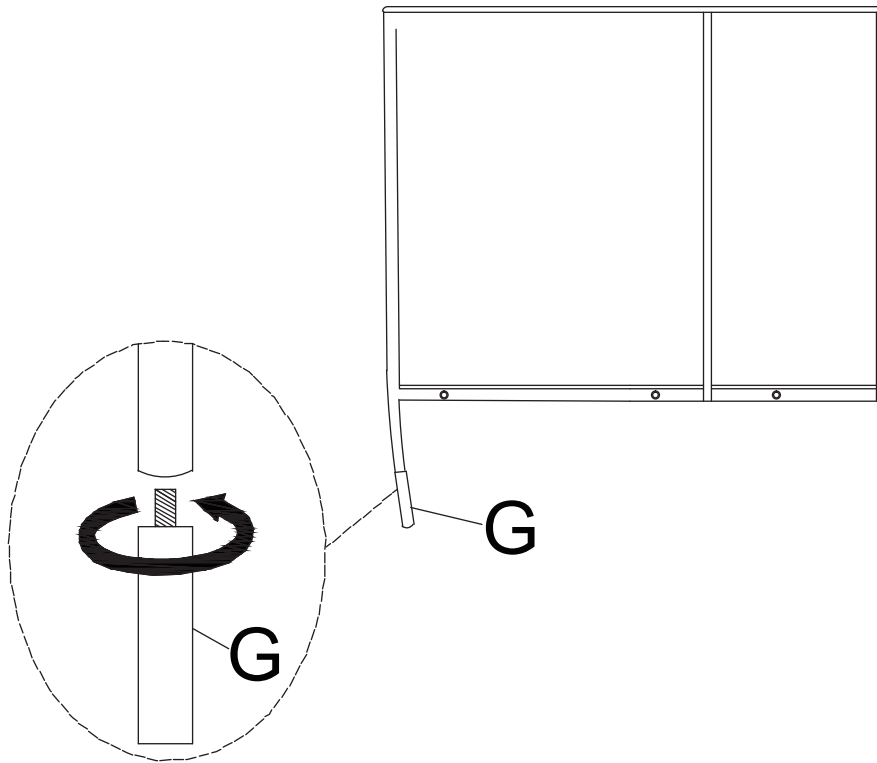

Part no.	Part	QTY	Image	Part no.	Part	QTY	Image
A1	Left arm	1		H	Seat cushion	3	
B1	Right back panel	1		I	Back cushion	3	
B2	Left back panel	1		J	Bolt (M6*45mm)	14	
C1	Right front panel	1		K	Bolt (M6*35mm)	10	
C2	Left front panel	1		L	Bolt (M6*15mm)	4	
D	Seat panel	3		M	Washer M6	28	
E	Foot	2		N	Allen wrench	1	
F	Side right panel	1					
G	Foot	1					

Step 1: Attach right back panel B1 to foot G, using Allen wrench N. Note: Don't fully tighten the bolts.



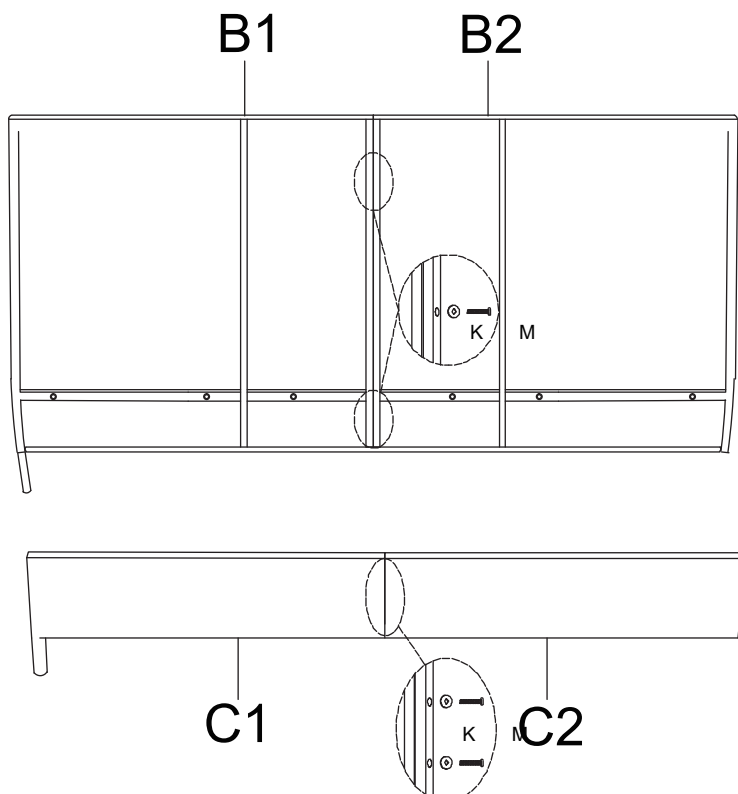

Step 2: Attach back panels B1&B2 with 2pcs bolts K and 2pcs washers M, attach front panels C1&C2 with 2pcs bolts K and 2pcs washers M, using Allen wrench N. Note: Don't fully tighten the bolts.



K		M6*35	4
M		Ø16*Ø6.5*1	4

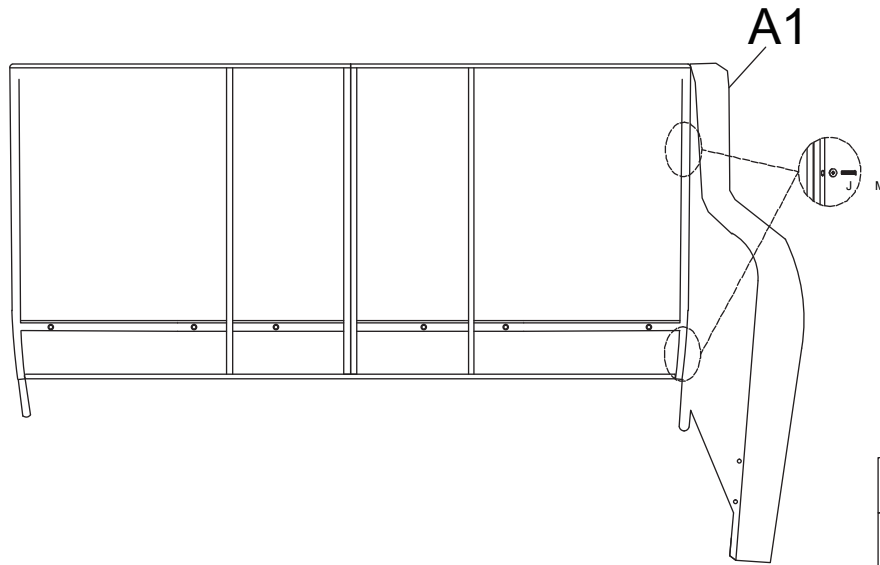

Step 3: Attach arm A1 to back panel B2 with 2pcs bolts J and 2pcs washers M, using Allen wrench N. Note: Don't fully tighten the bolts.



J		M6*45	2
M		Ø16*Ø6.5*1	2

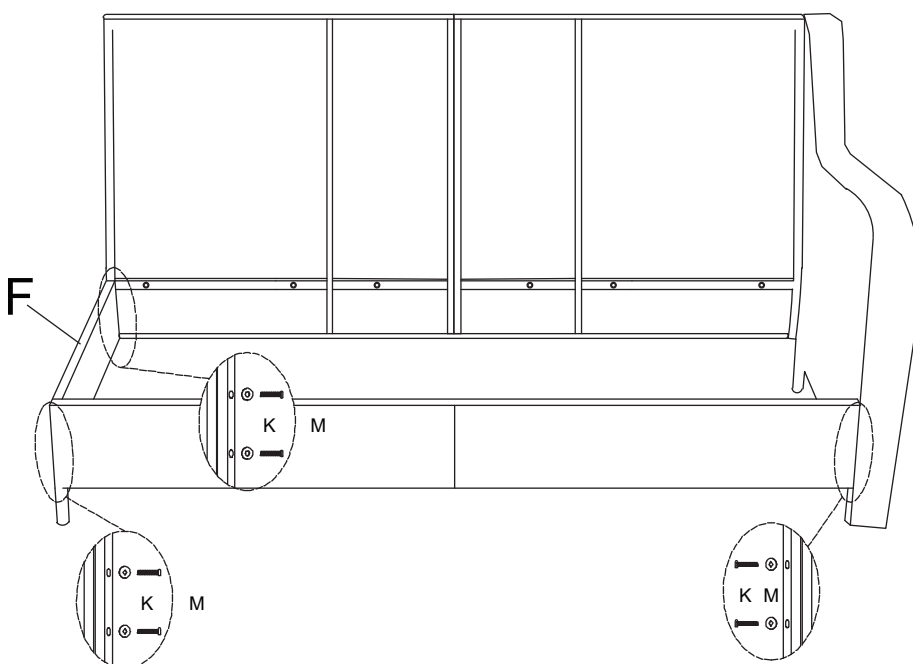

Step 4: Attach front panels C1&C2 to side panel F and arm A1 with 6pcs bolts K and 6pcs washers M, using Allen wrench N. Note: Don't fully tighten the bolts.



K		M6*35	6
M		Ø16*Ø6.5*1	6

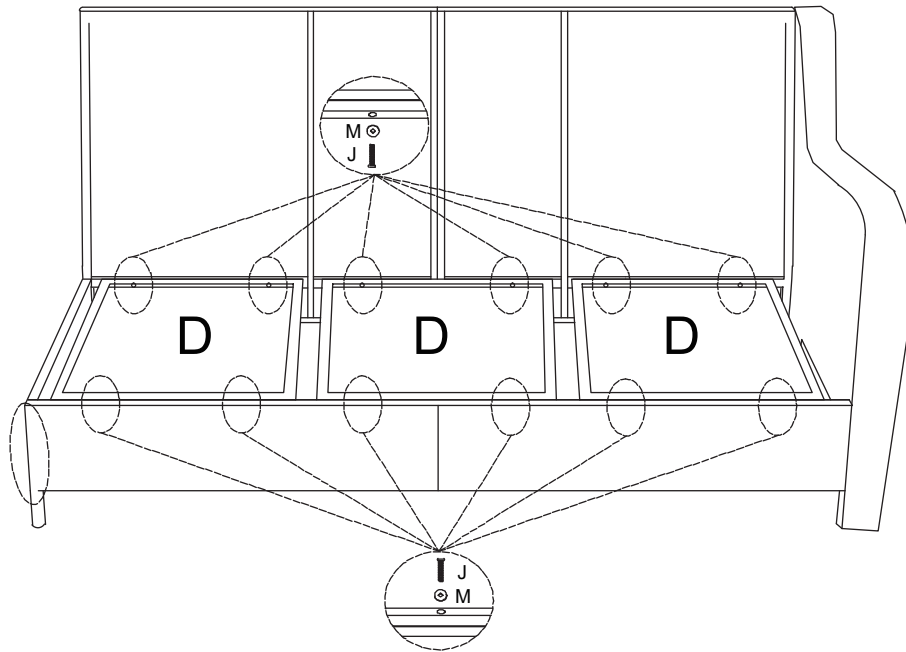

Step 5: Attach seat panels D to front panels C1&C2 and back panels B1&B2 with 12pcs bolts J and 12pcs washers M,using Allen wrench N.
 Note: Don't fully tighten all the bolts.

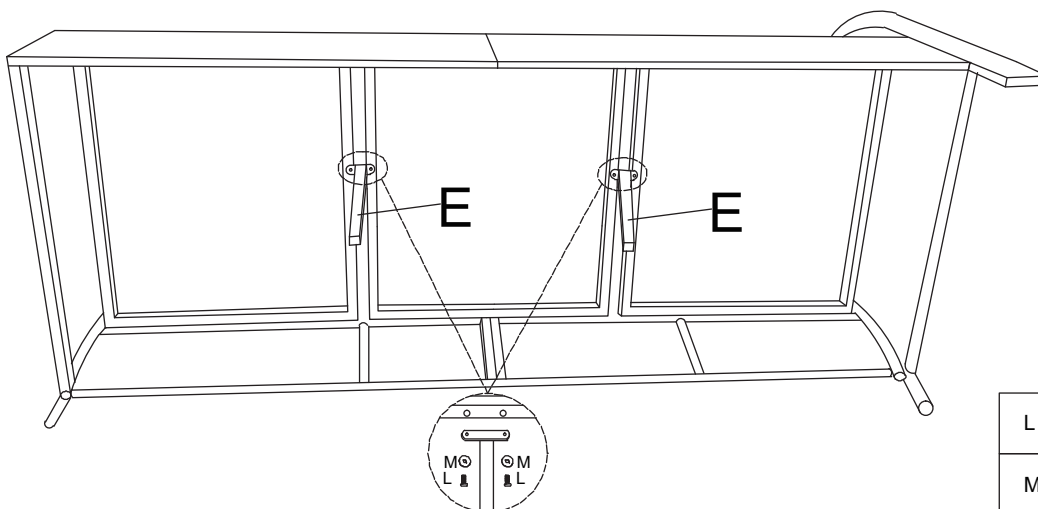

J		M6*45	12
M		Ø16*Ø6.5*1	12

Step 6: Attach feet E to seat panels D with 4 pcs bolts L and 4 pcs washers M,using Allen wrench N.Note:Please fully tighten all the bolts.



L		M6*15	4
M		Ø16*Ø6.5*1	4

Step 7: Put seat cushions H and back cushion I onto the seat . Assembly is now complete and the product is ready for use.

