

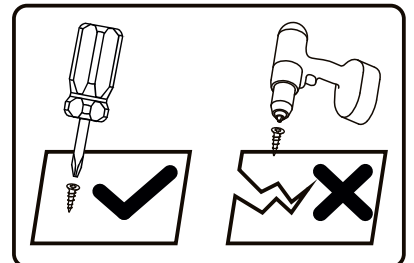

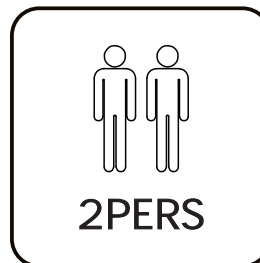

Assembly Instructions

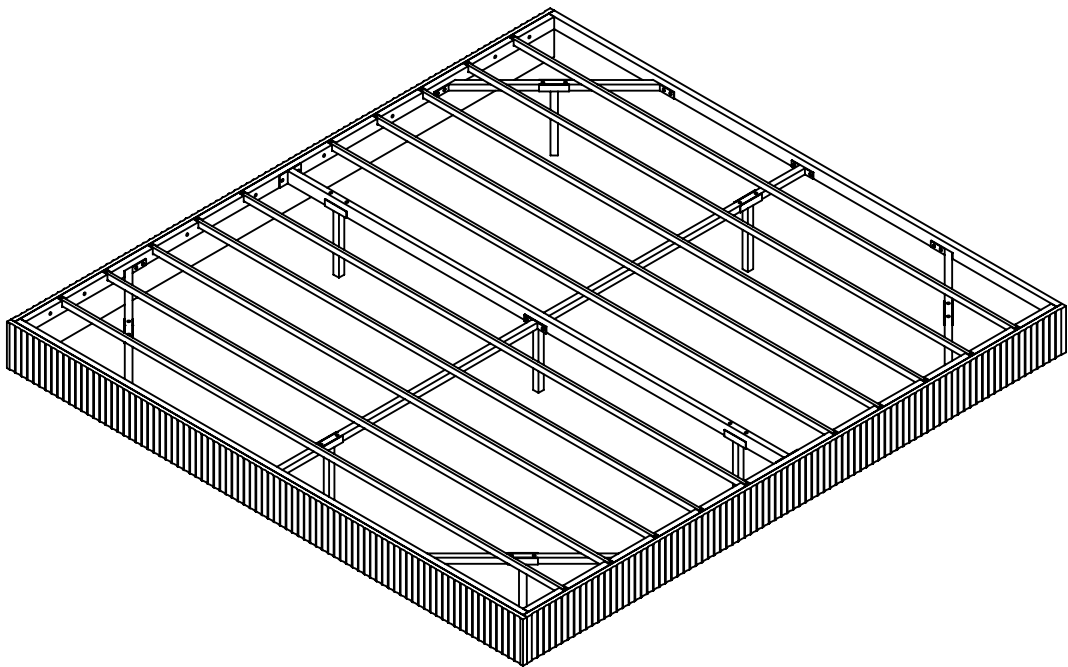
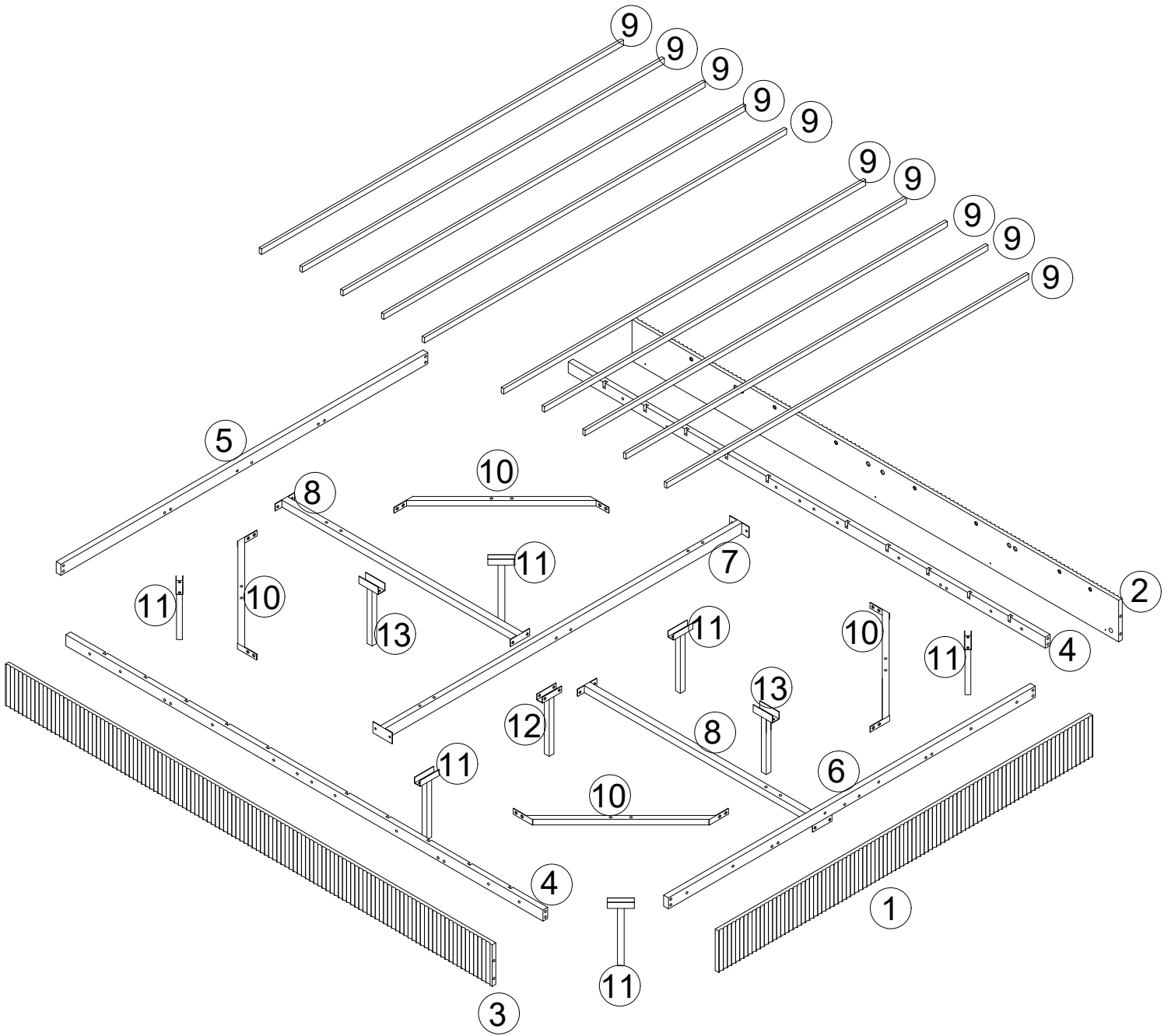
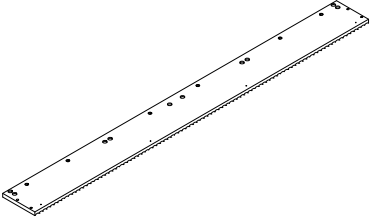
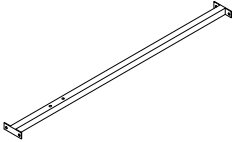
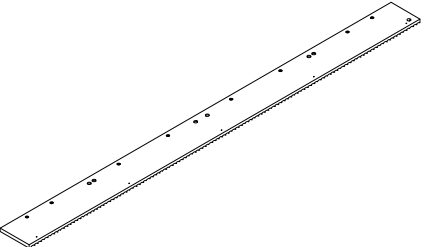
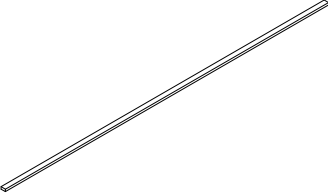
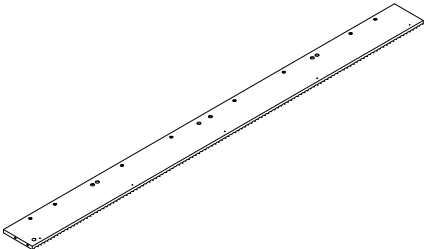
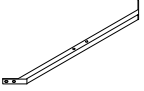
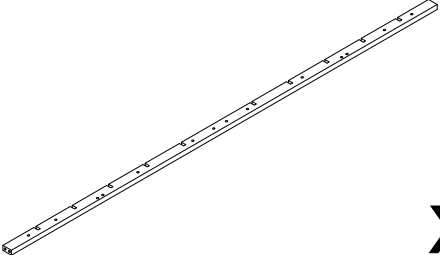
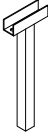
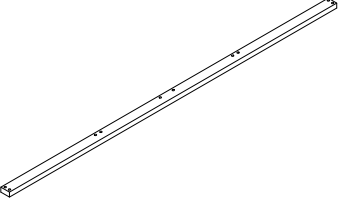
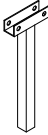
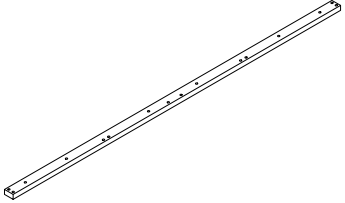
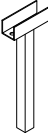
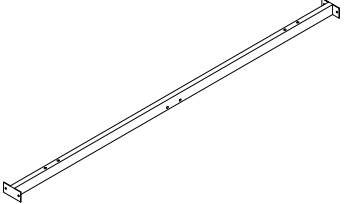

Tools Recommended



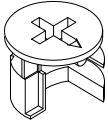
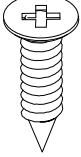
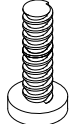
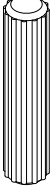
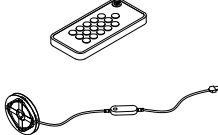
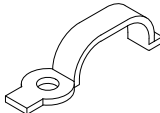
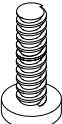
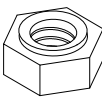
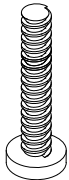
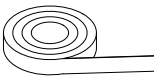
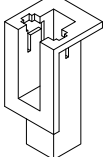
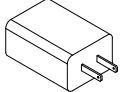

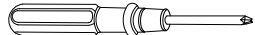

<p>①</p>  <p>x1</p>	<p>⑧</p>  <p>x2</p>
<p>②</p>  <p>x1</p>	<p>⑨</p>  <p>x10</p>
<p>③</p>  <p>x1</p>	<p>⑩</p>  <p>x4</p>
<p>④</p>  <p>x2</p>	<p>⑪</p>  <p>x6</p>
<p>⑤</p>  <p>x1</p>	<p>⑫</p>  <p>x1</p>
<p>⑥</p>  <p>x1</p>	<p>⑬</p>  <p>x2</p>
<p>⑦</p>  <p>x1</p>	

<p>(A)</p>  <p>ST x2</p>	<p>(B)</p>  <p>φ15 x2</p>	<p>(C)</p>  <p>M3*12mm x14</p>	<p>(D)</p>  <p>M6*35mm x14</p>
<p>(E)</p>  <p>φ8 x2</p>	<p>(F)</p>  <p>x1</p>	<p>(G)</p>  <p>x14</p>	<p>(H)</p>  <p>M6*28mm x54</p>
<p>(I)</p>  <p>M6 x42</p>	<p>(J)</p>  <p>M6*50mm x4</p>	<p>(K)</p>  <p>x1</p>	<p>(L)</p>  <p>x20</p>
<p>(M)</p>  <p>x1</p>			

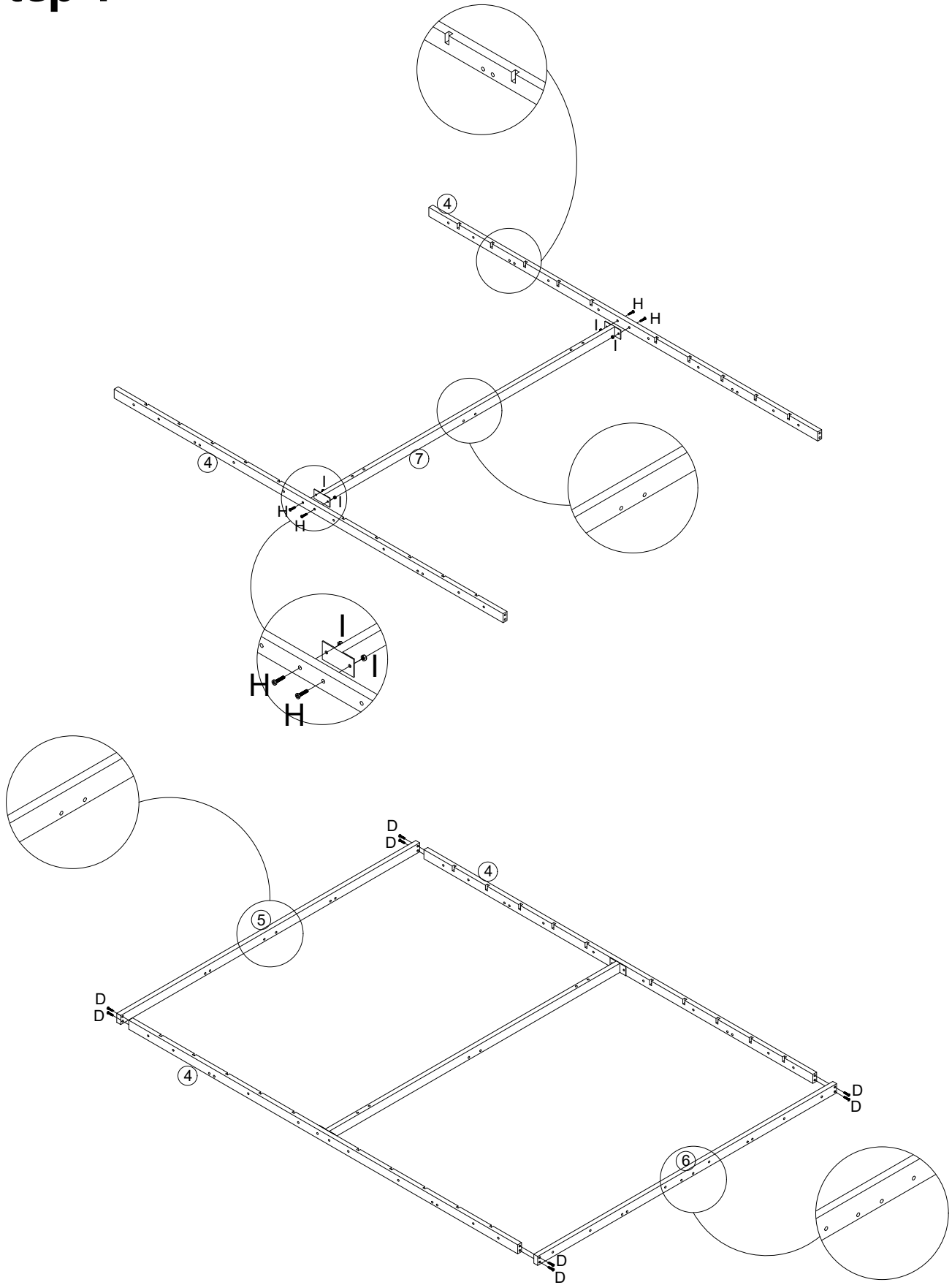
Our remote control does not come with a battery and can be used normally when connected to a mobile app.

Step 1





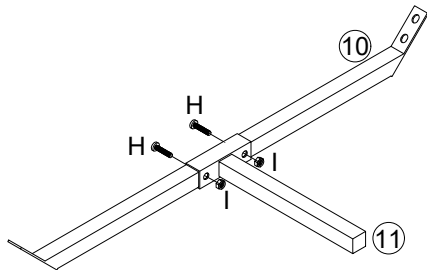

D		X8
H		X4
I		X4

Step 2

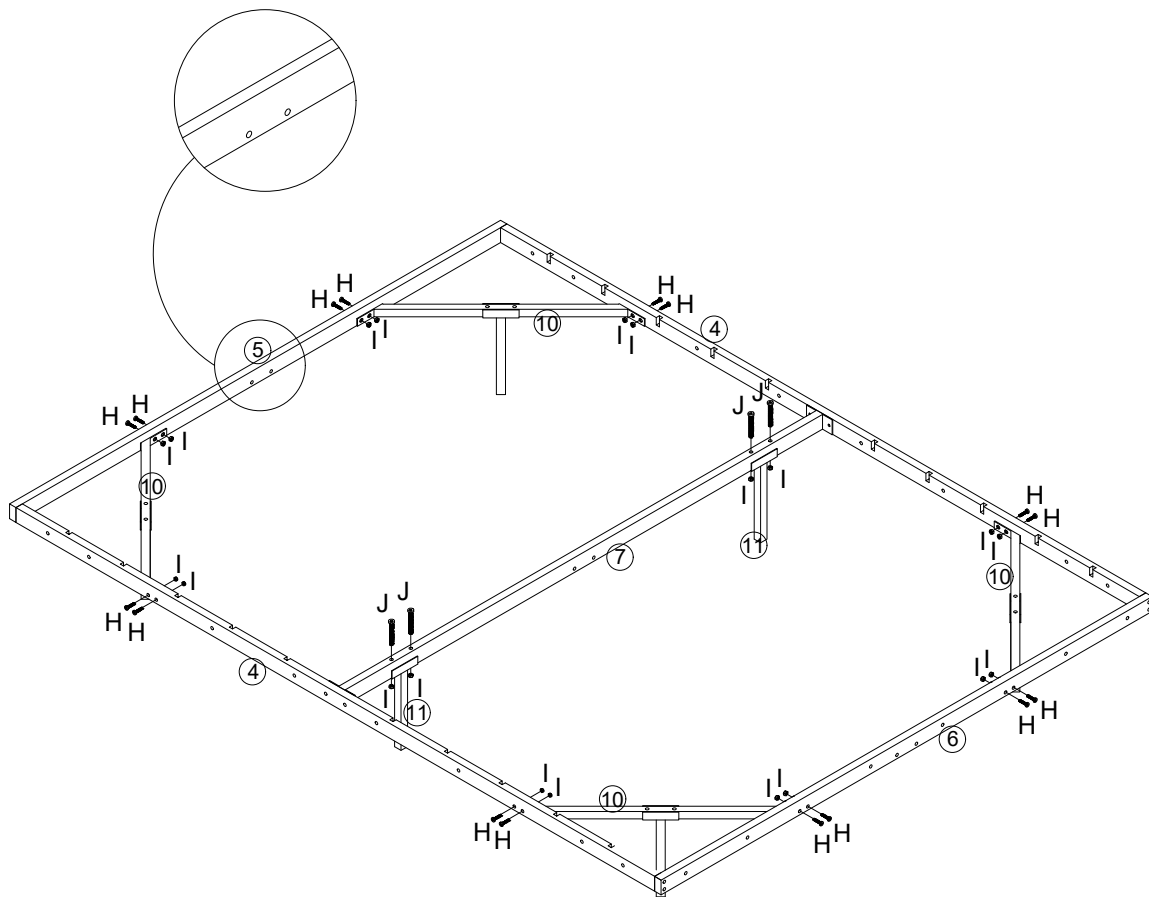





x4

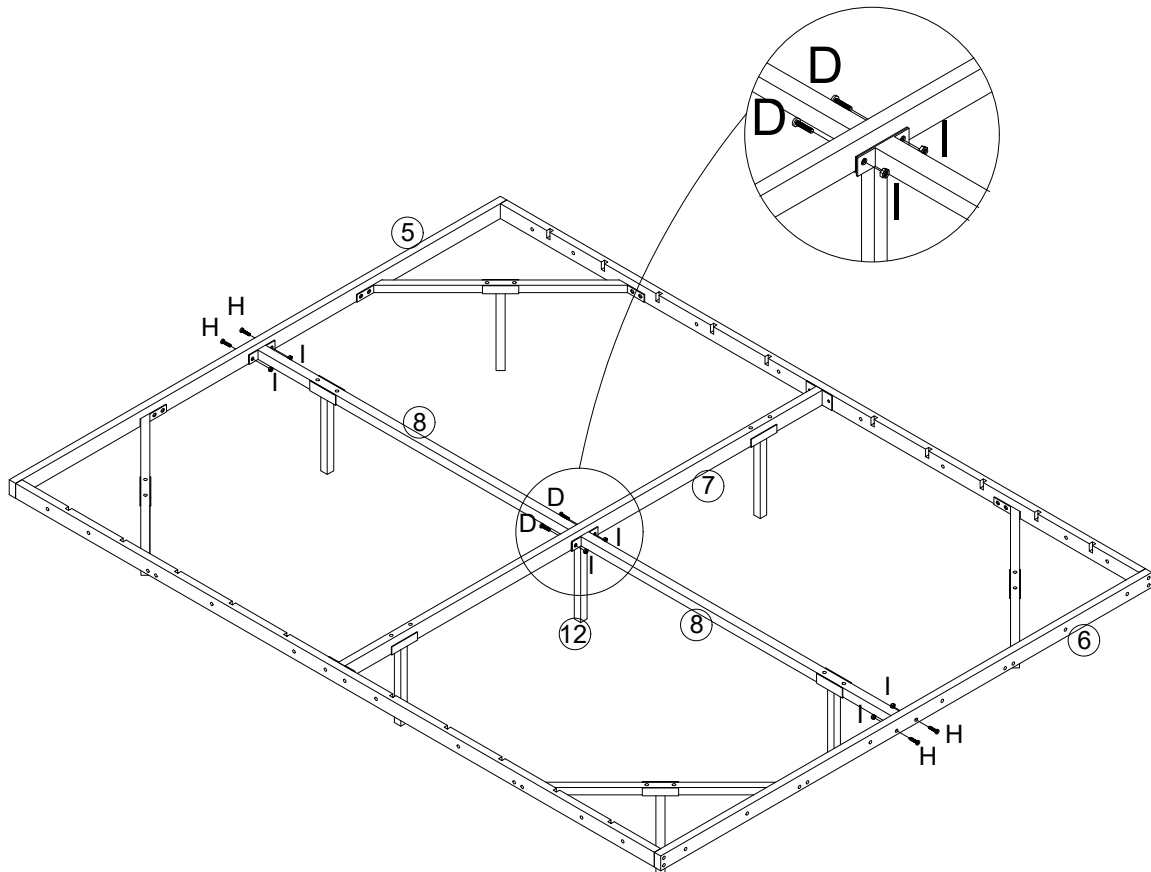
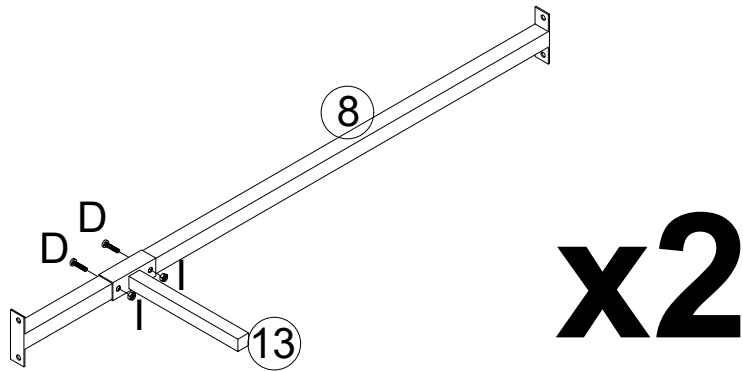

H		X24
J		X4
I		X28

Step 3



D		X6
H		X4
I		X10

Step 4

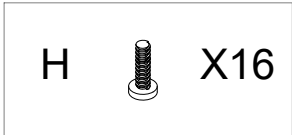
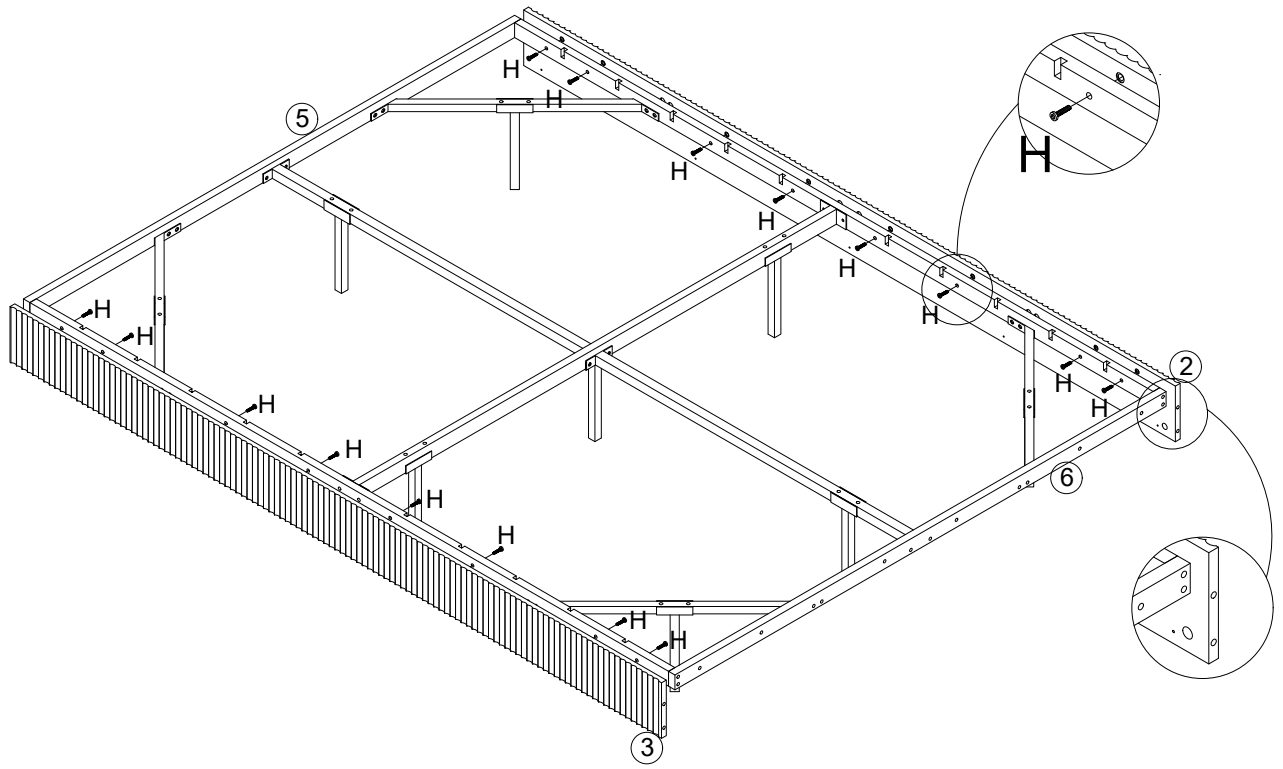



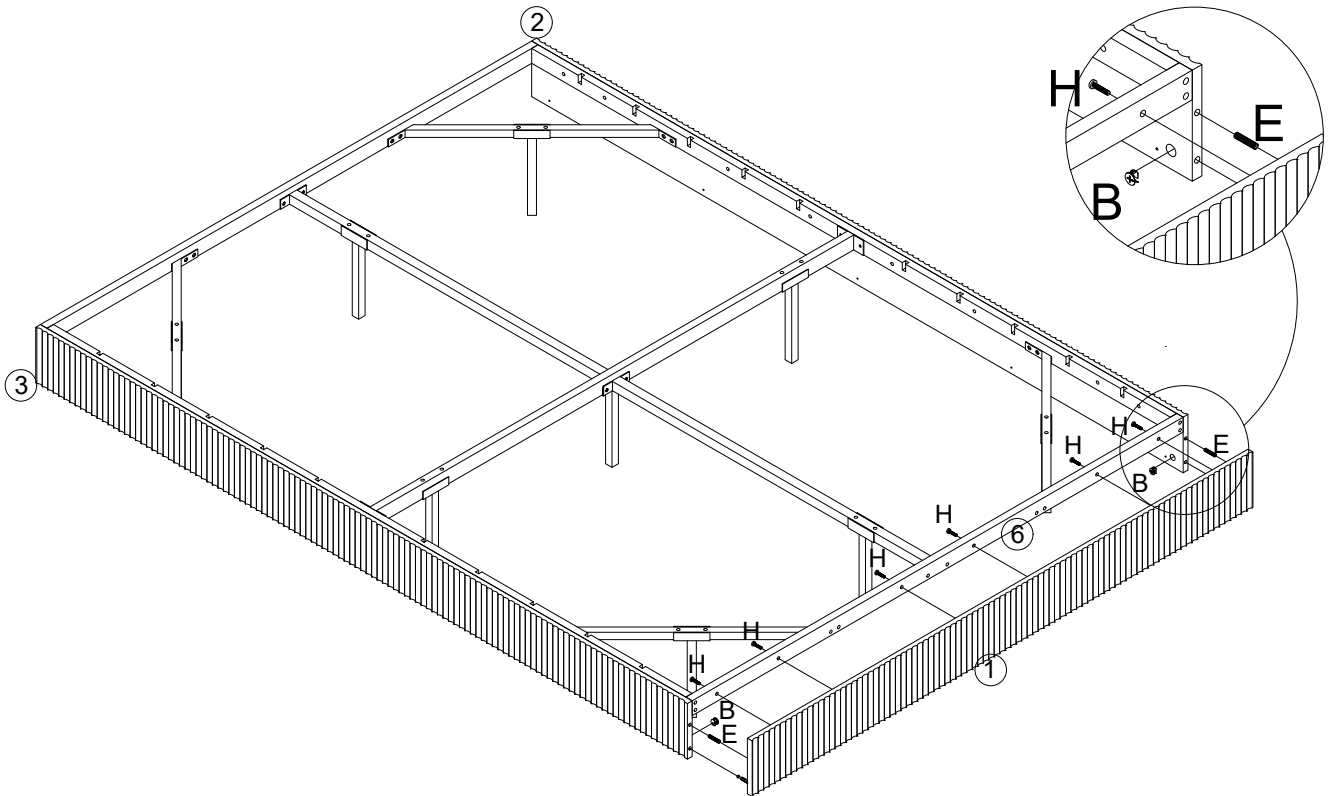
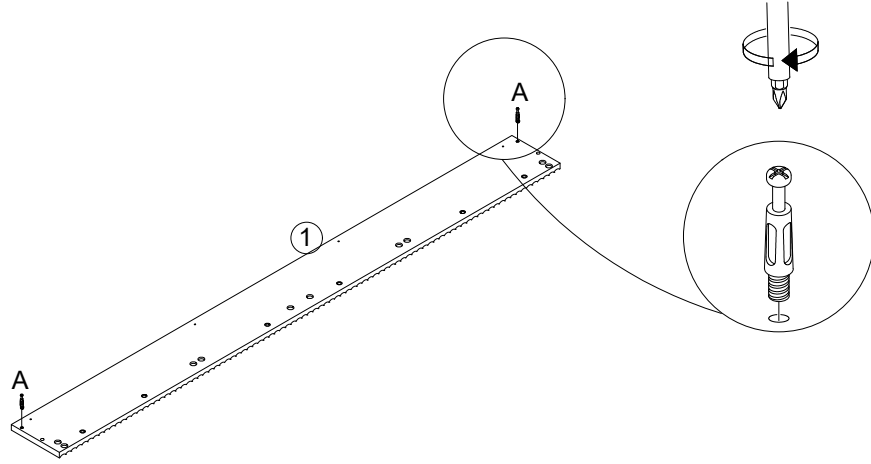
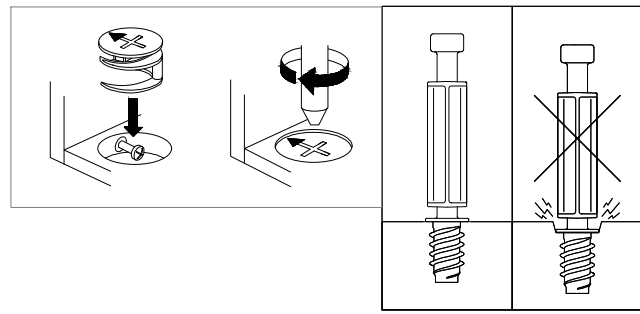

Step 5

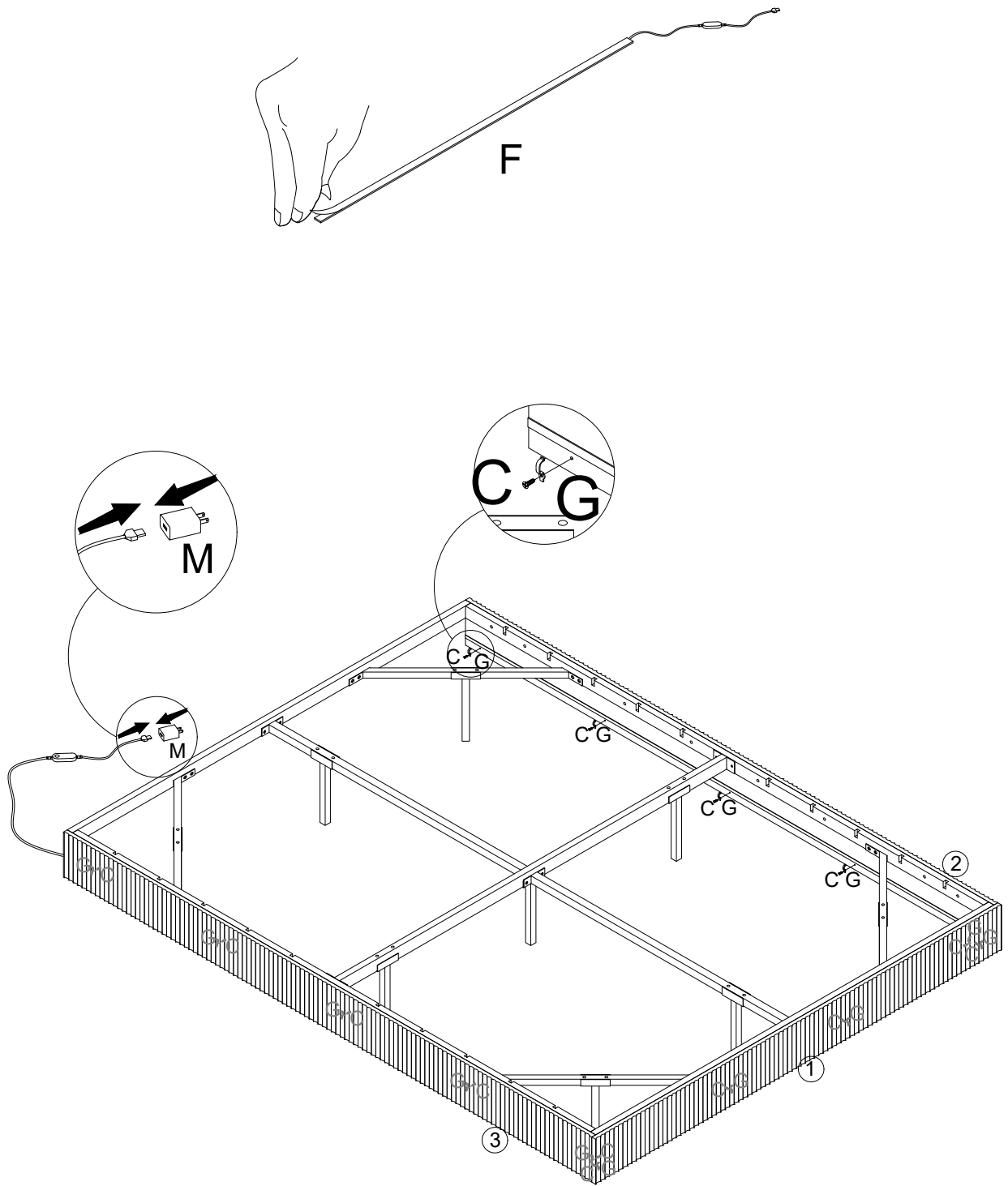

A		X2
B		X2
E		X2
H		X6

Step 6



C		X14
F		X1
G		X14
M		X1

Step 7

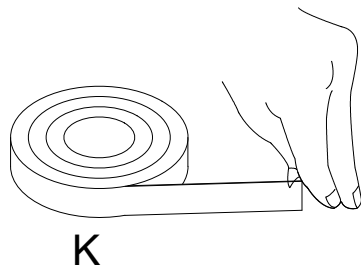

Please cut the length according to your own needs

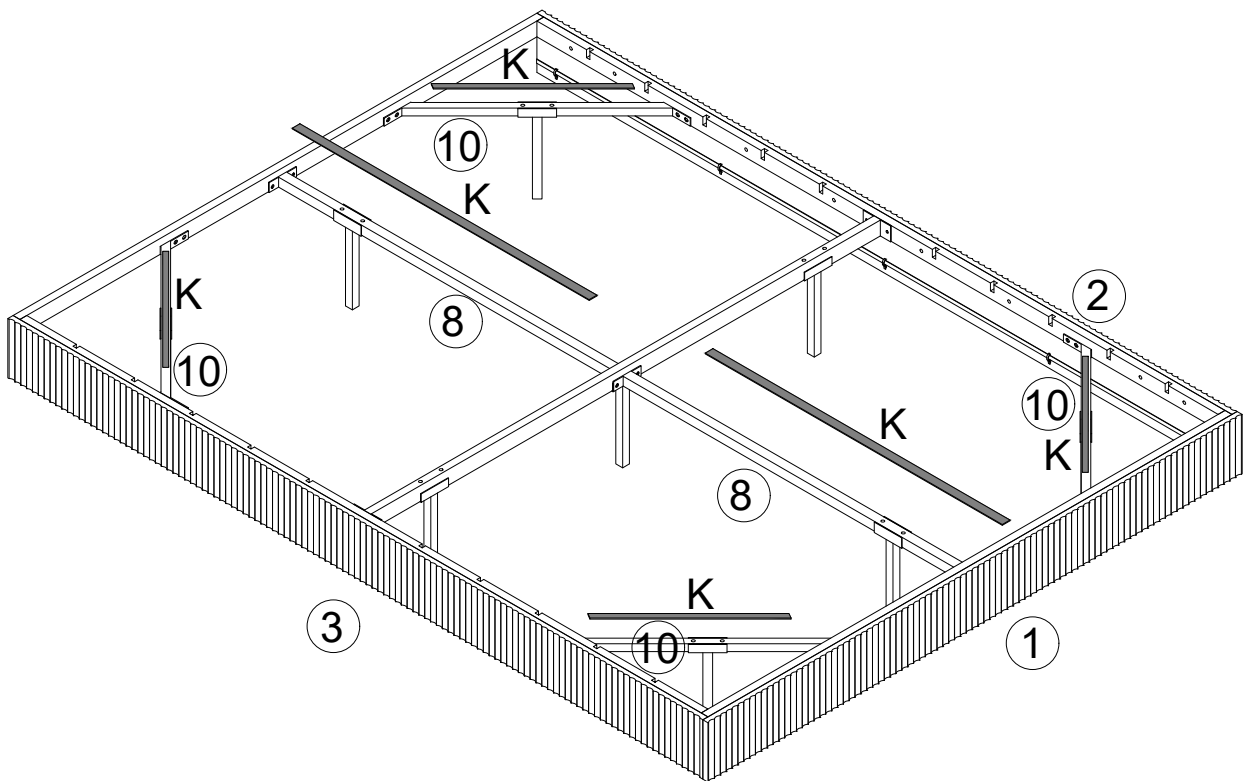

Step 8

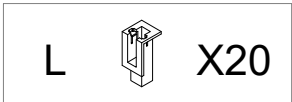
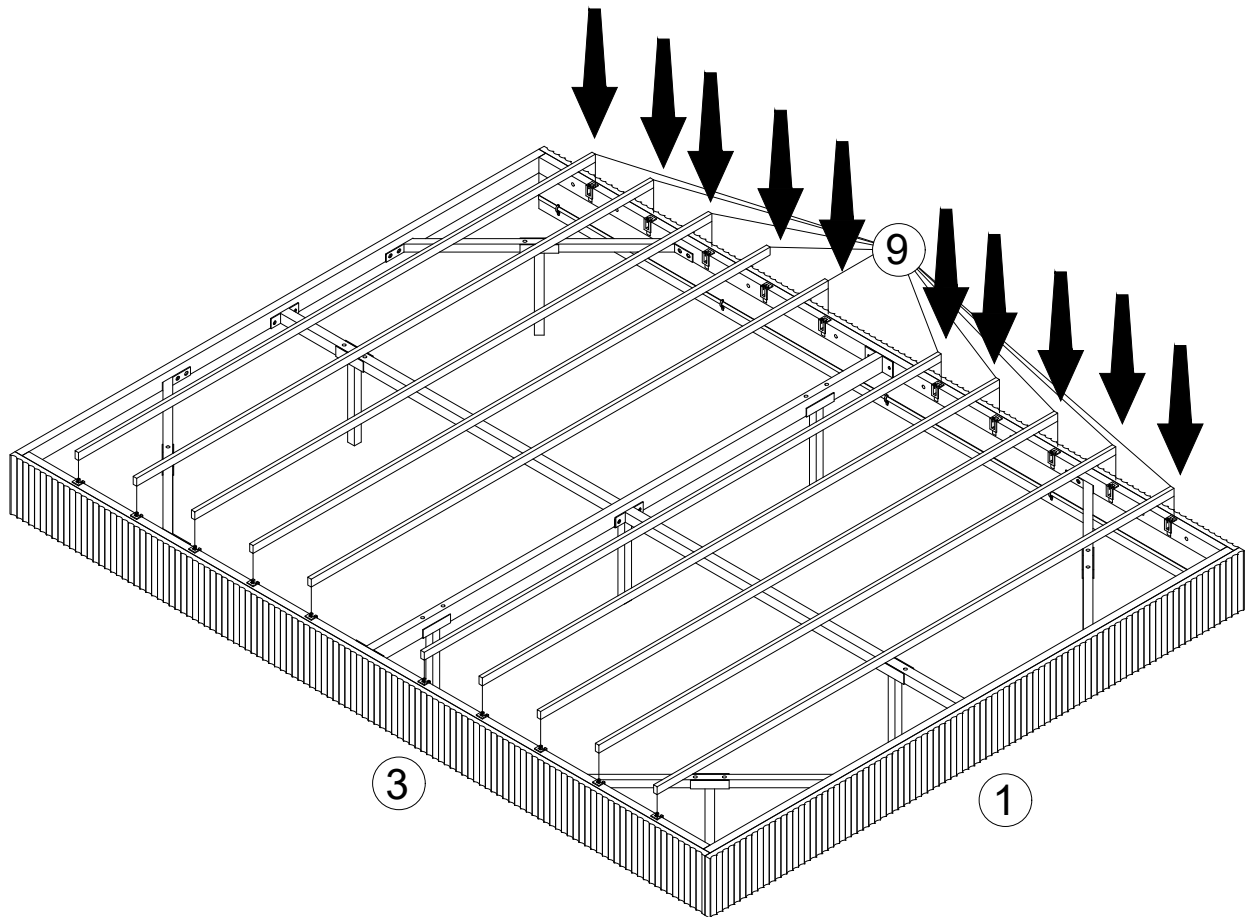
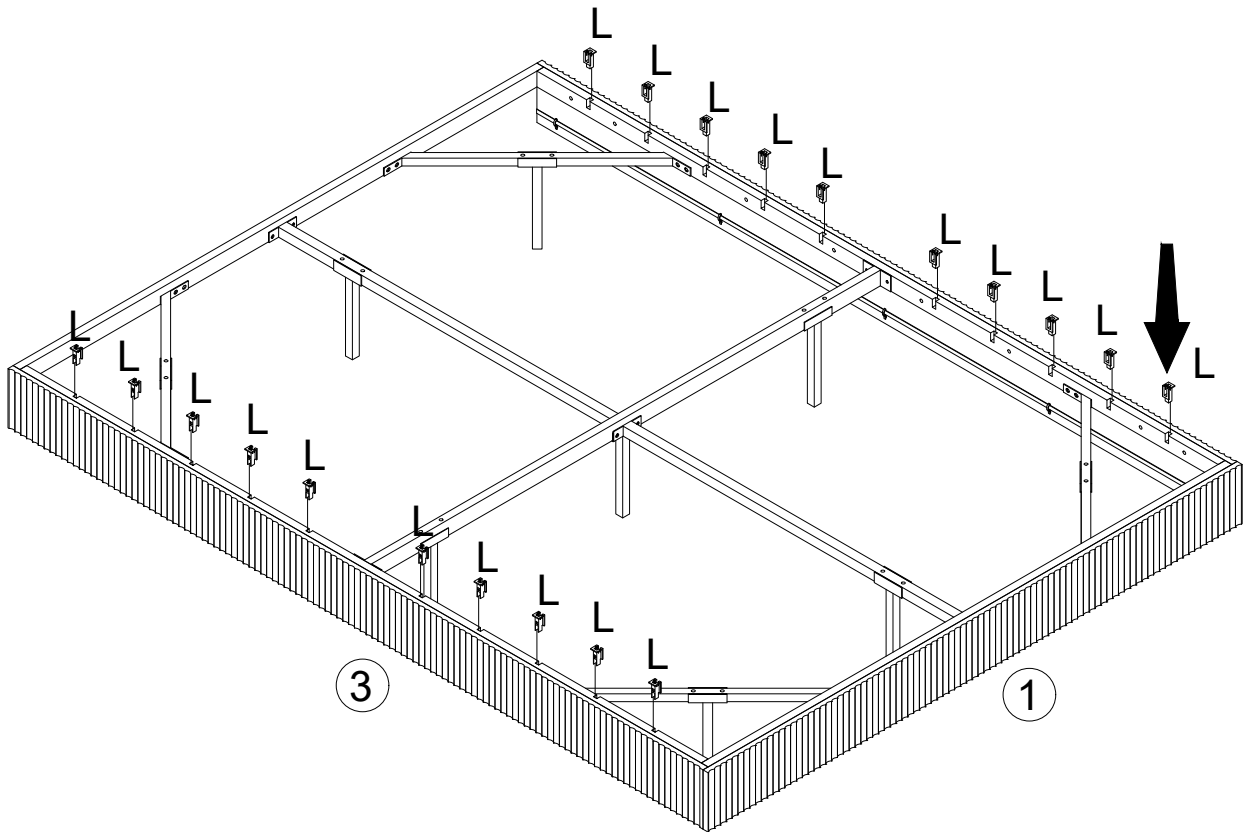

Step 9

