

Owner Manual



WARRANTY

We strive to offer high quality product and we also try our best to satisfy each customer that order from us, no matter on products or services as needed. Each customer receives a record of their order, such as the order number or item receipt. For any items that are out of warranty period, you may still be able to purchase the replacement parts from our company if they are available.



MAINTENANCE AND WARNING

Please read the manual thoroughly
before you start installing.

Please keep the product away from
sharp object.

Packaging and small parts may have
chocking hazard, please keep them away
from children and pets.

Please clean the product according to each
clean code, check the product description
for more information.

Please keep the product away from
fire.

If you have any other questions, please
contact us, we will be glad to help you out.

If the product is placed under direct
sunlight, the pattern or color might fade
away overtime.

Check the product periodically to make
sure everything is secured and tightened.

Always use proper tools for installation.

Do not jump on the product.

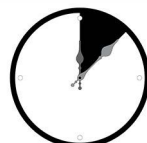

PRODUCT DESCRIPTION

Simple outdoor adjustable lounge chair. Features sleek, modern lines and distinct woven texture for a natural, relaxed look.

Easily blends into outdoor settings like balconies, patios, or gardens.

Metal frame and woven rope. The main structure is a sturdy metal frame with strong load-bearing capacity and stability.

The surface is wrapped with durable, breathable woven rope, offering a ventilated and resilient structure ideal for long-term outdoor use.

Ergonomically designed thickened cushion: The thickened design effectively disperses

fering cloud-like support.

High-density foam filling. The seat and back cushions are plump and substantial, offering a soft sinking sensation with firm support. Ensures comfort for extended lounging and resists sagging.

Water-repellent cotton-blend fabric. Offers splash resistance, easy cleaning, and quick-drying properties. Handles outdoor dew or accidental rain splashes with ease. Simple to maintain with a damp cloth.

PARTS

A*1



Right arm

B*1



Left arm

C*1



Backrest

D*4



Connector bar

E*2



Front bar

F*2



Back cushion

G*1



Seat cushion

Hx2



Bag

Ix1



Seat cover

Jx2



Backrest cover

★The Cover with the washing label is the Backrest Cover

HARDWARE

TOOL LIST

NOTE: Designated with (★) We provide additional spare parts in the hardware package

①*10



★ M6*50mm
Bolts

③*1



Allen key

④*8



★ Vertical nut

⑤*12



★ Black hole
cover

⑥*2



M6*30mm
Bolts

⑦*8



★ M6*25mm
Bolts

⑧*20



★ Ø6*14mm
Flat washer

Please make sure all hardware&packing material fitting the list.
Especially some small accessories may be missing during
transportation. Please contact us if you have any question.

step 1 ---Cut the plastic air compression bags

Take out the roll of compressed product from the box.

Cut open the compression bag along the paper strip on the roll bag. Remove the sofa and let them rest to recover their shape.

Full recovery may take up to **72** hours, but you can gently slap the sofa to speed up the process.

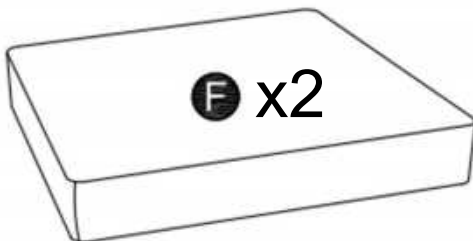
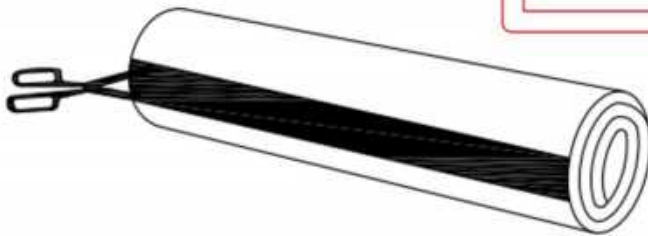
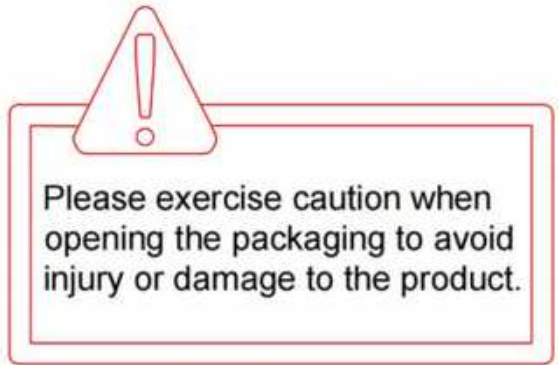

step 2 ---Cut the plastic air compression bags

Cut the plastic air compression bags, and take out the cushion (G). Let it recover to its original shape, the whole recovery process might take **48** hours, you may gently slap on it to speed up the process.

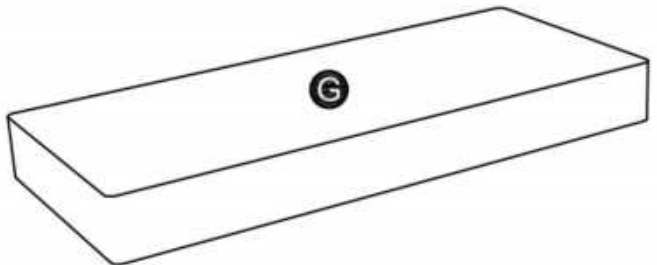
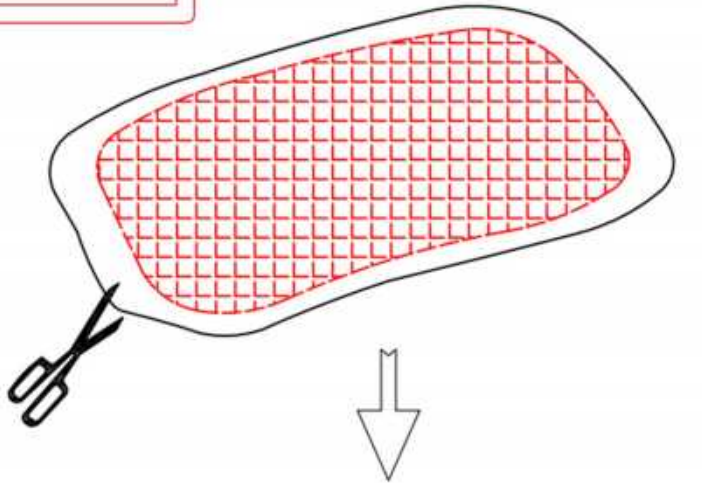
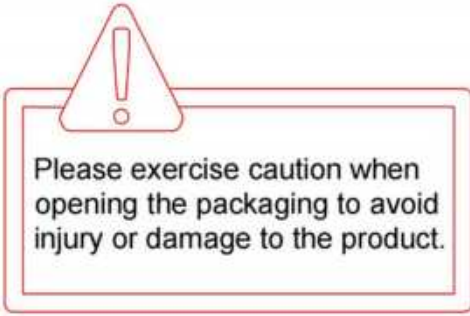

step 3 ---Take out the cushion cover

Open the bag, take out the seat cushion cover (I) and back cushion cover (J).

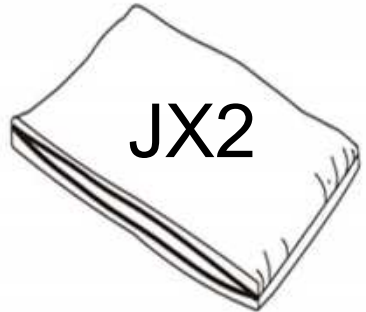
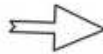
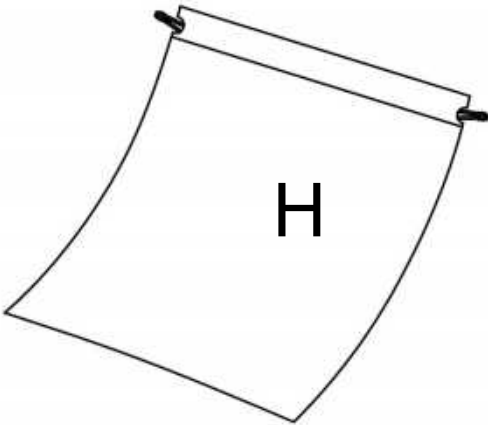
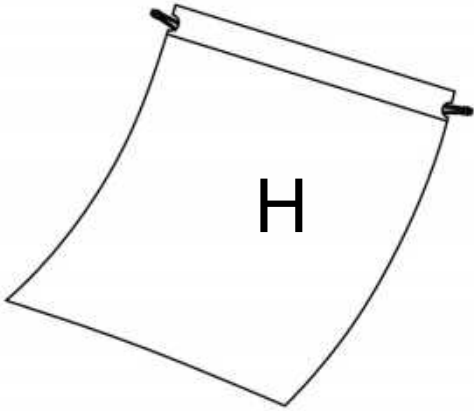

step 4 ---Put on the cushion cover

How to Put on the Cushion Cover

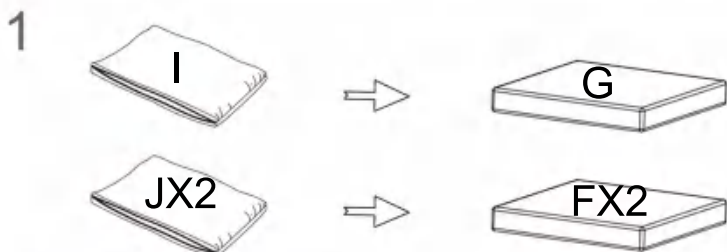

1. Take the cushion covers and inner inserts out of the carton.



2. Fold the inner in half, pushing the sides together, then begin to slide the cover onto it.



3. Align both far corners, then gently compress insert while fitting cover around it.



4. To avoid a stuck zipper, please pull the fabric away from the zipper before moving forward.

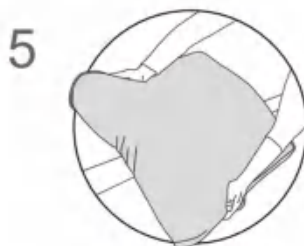

5. When all done, please pat the cushion or give it a little shake to make it more flat.

step 5 ---Install the Right Arm (A)

Insert the Hammer Nuts (4) into the pre-drilled holes on the Front Bars (E). Ensure the holes on the side of the Hammer Nuts align with the holes on the sides of the Front Bars. Place one flat washer (8) on each bolt (1). Then, use the provided allen wrench(3) to secure the Left and Right Legs to the Front Bars as shown. Tighten all bolts to 80%.

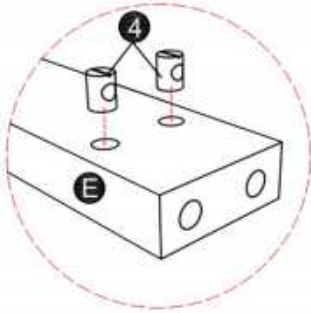

First add one flat washer on each bolt as shown, use the allen wrench provided to tighten all the bolts by 30-50% first, make sure that all bolts are aligned correctly before fully tightening.

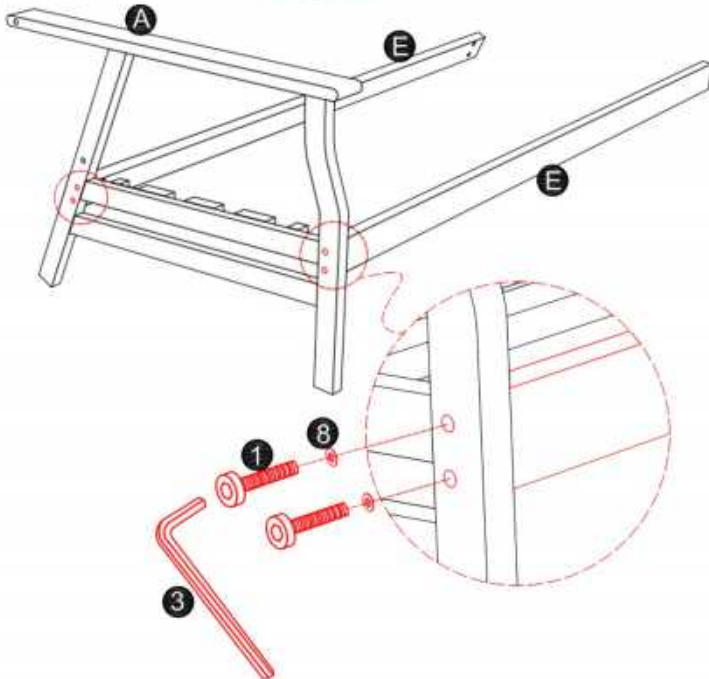

step 6 ---Install the Left Arm (B)

Place one flat washer (8) on each bolt (1). Then, use the provided allen wrench (3) to secure the Left and Right arm to the Front Bars as shown. Tighten all bolts to 80%.



First add one flat washer on each bolt as shown, use the allen wrench provided to tighten all the bolts by 30-50% first, make sure that all bolts are aligned correctly before fully tightening.

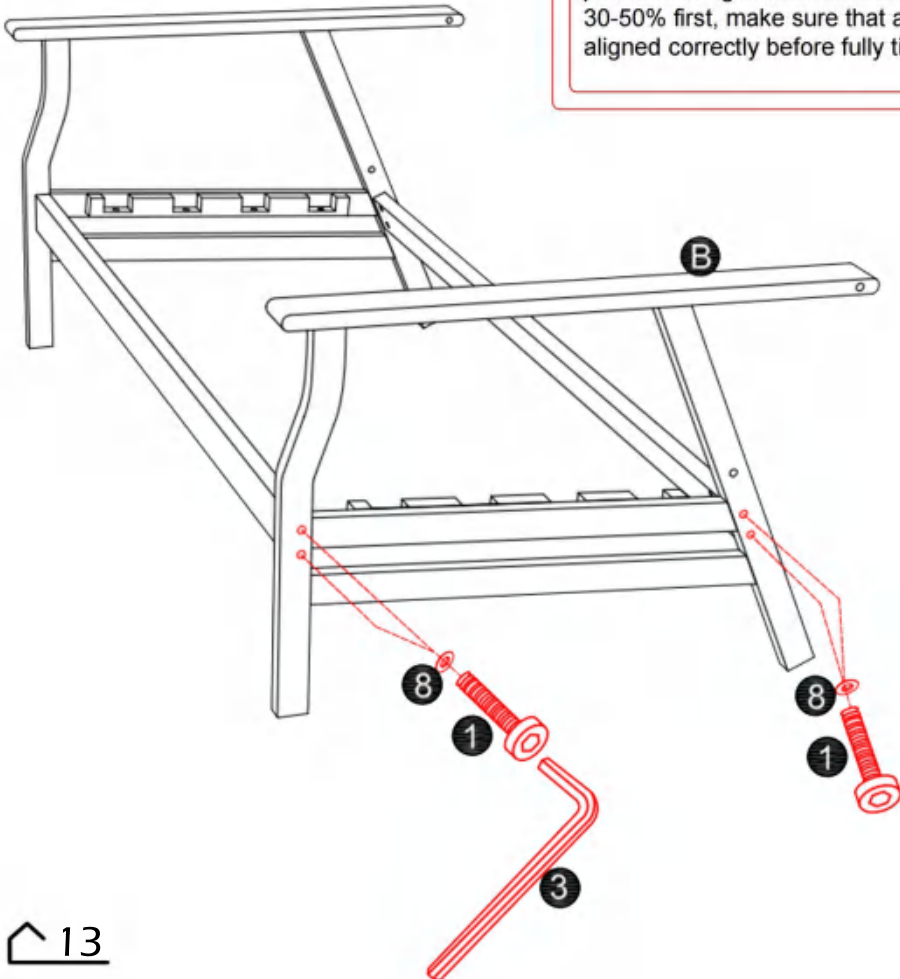

step 7 ---Install the Wood Frame Bars (D)

Align the Wood Frame Bars (D) with the designated grooves on both the Left and Right Arms (B&A), as shown. Place one washer (8) on each bolt (7), then use the provided allen wrench (3) to tighten all bolts.

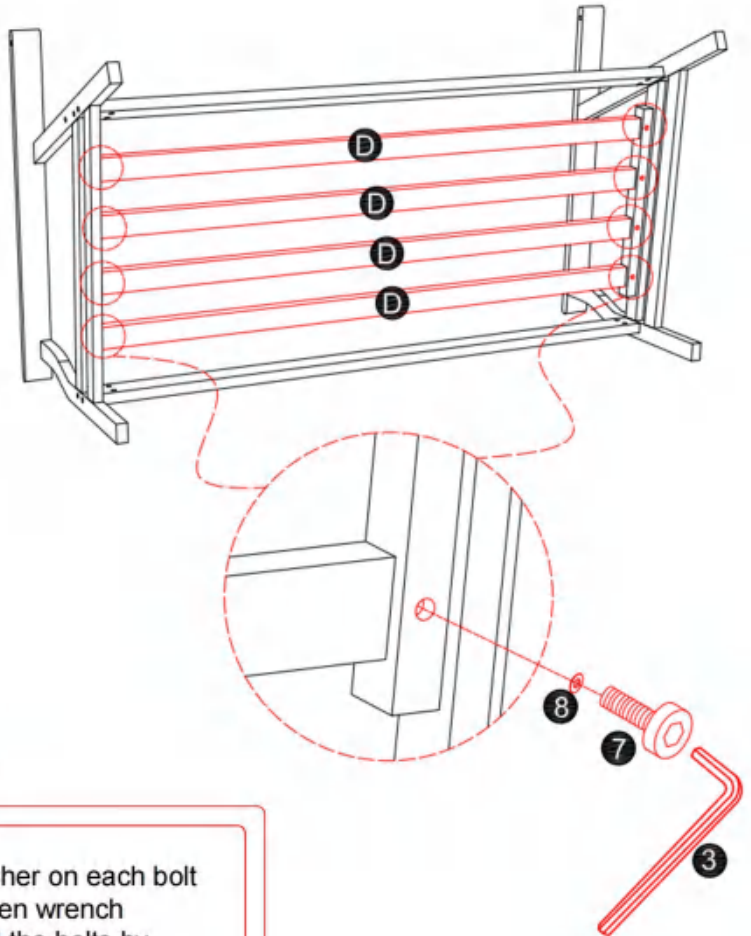

First add one flat washer on each bolt as shown, use the allen wrench provided to tighten all the bolts by 30-50% first, make sure that all bolts are aligned correctly before fully tightening.

step 8 ---Install the Back Frames (C)

Stand the assembled unit on its legs. Install the Back Frames (C) to the Arms as shown. Use the provided allen wrench (3) to fully tighten all bolts (1) and washers (8) including from previous steps.

First add one flat washer on each bolt as shown, use the allen wrench provided to tighten all the bolts by 30-50% first, make sure that all bolts are aligned correctly before fully tightening.

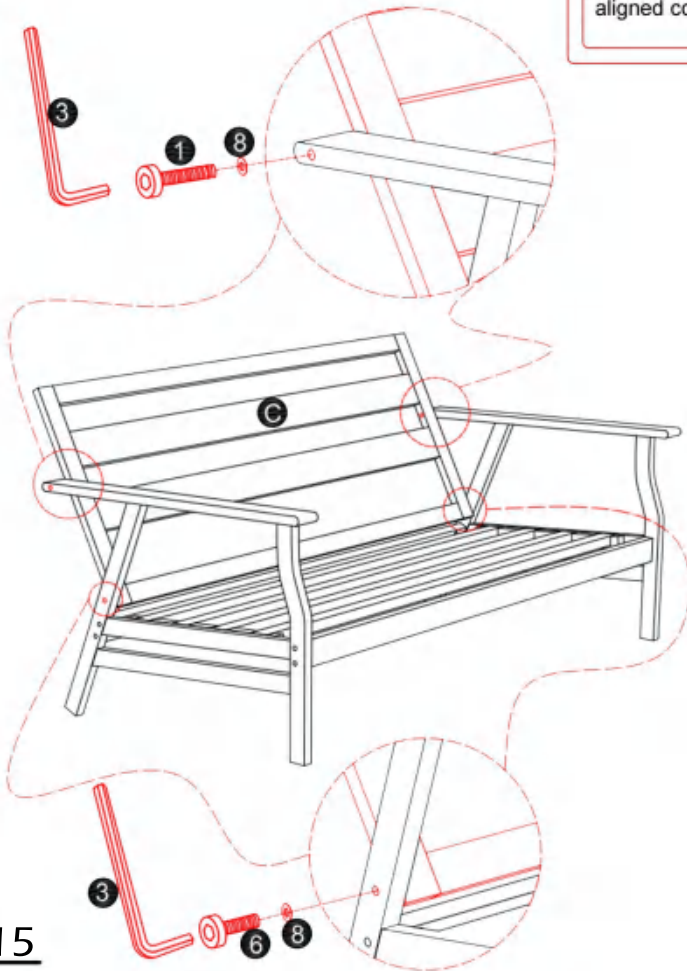

step 9 ---Place the Plastic Caps

Place the Plastic Caps (5) to cover all bolt holes, as shown.

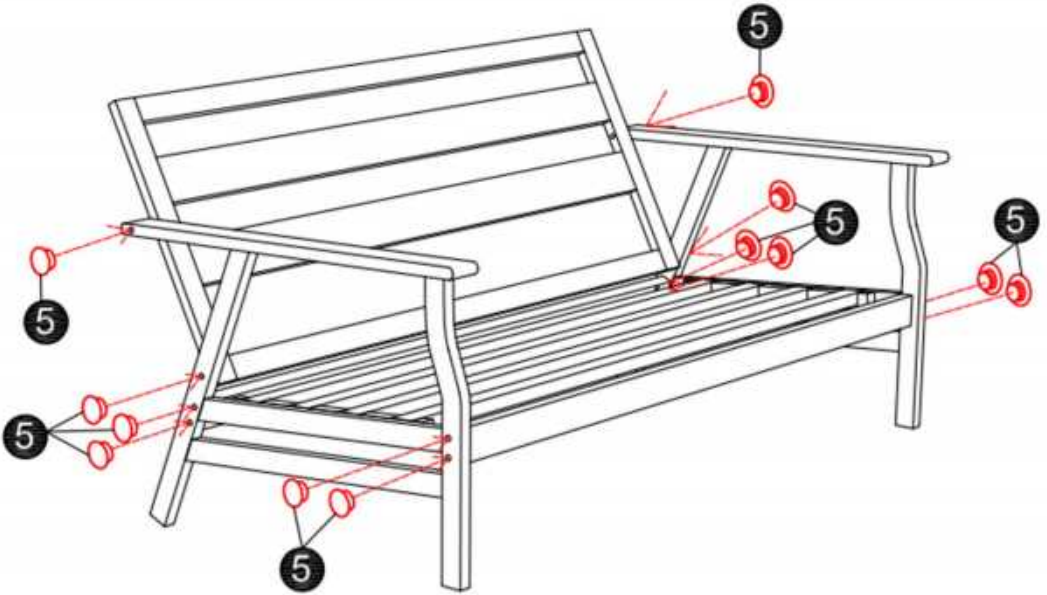

step 10 ---Place the Seat cushion(G) & Back cushion (F)

Turn the Back cushion & Seat cushion with the labeled side facing up.

Place the Seat cushion(G) on it.

Place the Back cushion(F) on it.

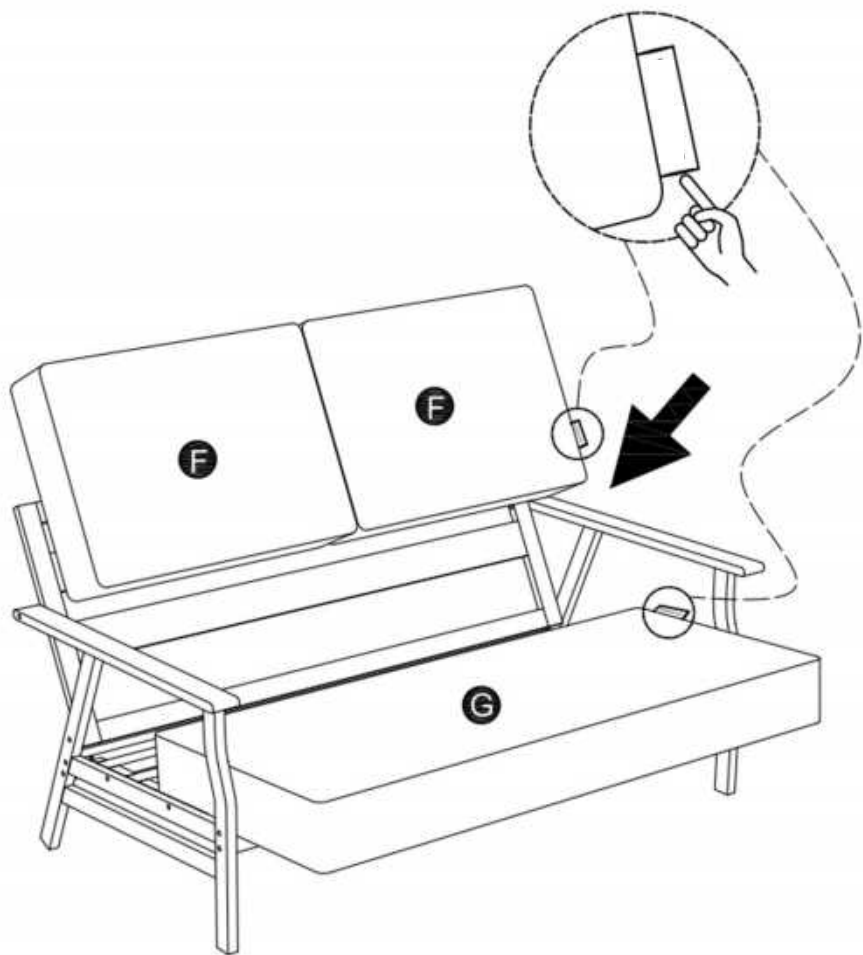

step 11 ---Assemble complete

Congratulations! You have finished the assembly, thank you again for choosing our product! Please enjoy!

