

# ASSEMBLY INSTRUCTIONS

---

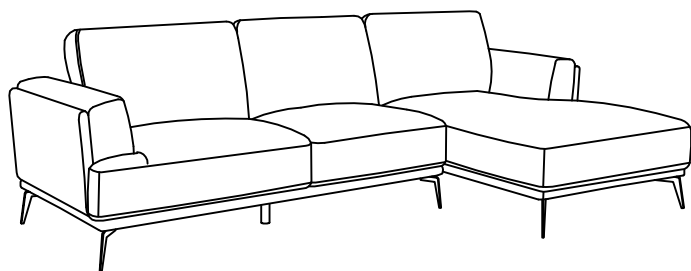

**OR**

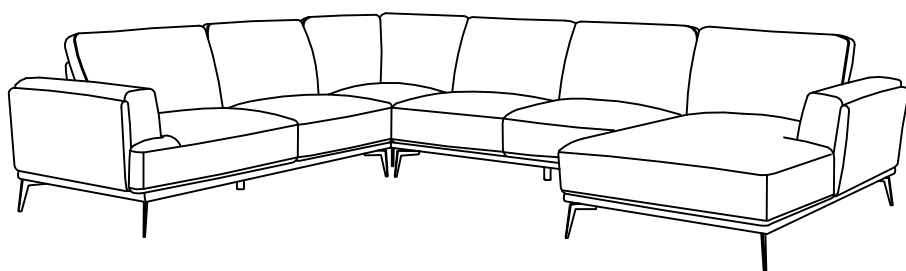

## TOOLS REQUIRED



**Allen Wrench**

(Included)



**Phillips  
Screwdriver**

(Not Included)



**2 - People  
Recommended**

## ASSEMBLY RATING



EASY —————> DIFFICULT

The Assembly Rating is a 5-point system showing the level of effort needed to assemble a specific product.



## **CHECK BEFORE STARTING**

### **Are you missing anything?**

Double-check all parts, hardware and accessories listed are all accounted for.

### **Check out our Quick Tips!**

We recommend reviewing the pre-assembly handouts. Even experts need a refresher now and then!

### **Should we send any replacements?**

Are there any irregularities or flaws in the parts? We can send replacements!

### **Prep Time!**

Please review the assembly instructions and all diagrams prior to assembling.

# PRE ASSEMBLY INTRODUCTION

We understand building ready-to-assemble furniture can be a challenging experience for some. To help avoid confusion, we have provided some helpful tips that may speed up the process.

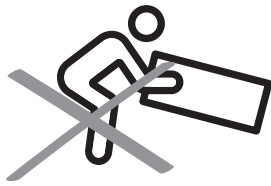

## Teamwork

ALWAYS have at least two people to help with transporting and assembling the product to avoid potential injury and/or damage.

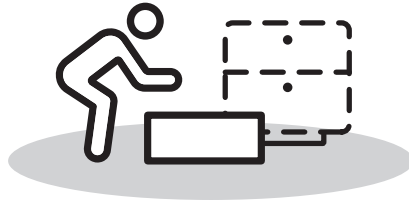
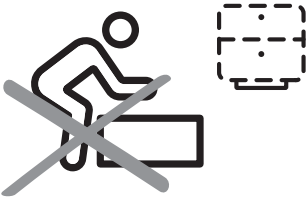

## Suitable Location

Assembling near the area of the intended location is highly recommended.



## Sufficient Space

Make sure you have enough space to move around during the assembly.

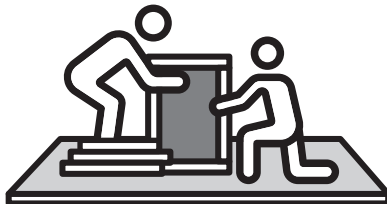

## Avoid Scratches

Use cardboard, blankets or a carpeted area while assembling furniture to prevent to prevent scratches and damages.

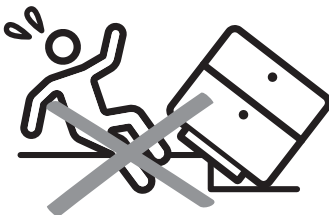

## Flat Surface

Make sure the furniture rests on a flat and level surface with each leg evenly touching the floor.

# ASSEMBLY AND CARE ADVICE



**FAILURE TO FOLLOW THE GUIDELINES BELOW MAY RESULT IN INJURY AND/OR PROPERTY DAMAGE.**



Position each part correctly and insert screws or bolts into their respective holes.

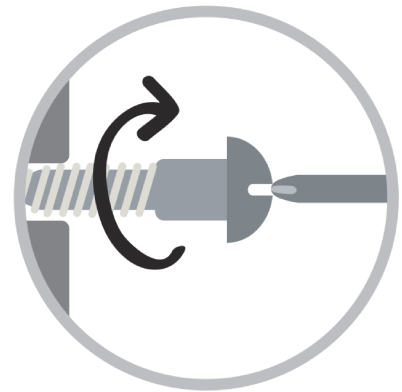

Turn clockwise to tighten and only tighten when step is completed or when instructed to do so.



Use the appropriate hand tools or power tools for assembly. Select steps, such as tightening screws and/or bolts, may require hand tools to avoid causing damage during assembly.



Save the instructions and store any supplied tools for later maintenance.

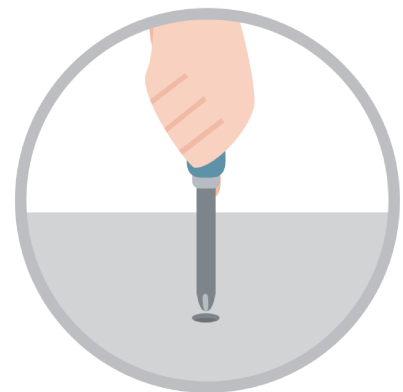

After two weeks, check and tighten any loose hardware and repeat again every six months thereafter.

**IT IS THE USER'S RESPONSIBILITY TO MAINTAIN THE FURNITURE. THE HARDWARE MAY LOOSEN OVER TIME AND MAY CAUSE THE FURNITURE TO BE WOBBLY AND UNABLE TO SUPPORT ITS INTENDED WEIGHT CAPACITY. THIS MAY LEAD TO COLLAPSE AND MAY CAUSE SERIOUS INJURY.**

# CORNER SOFA

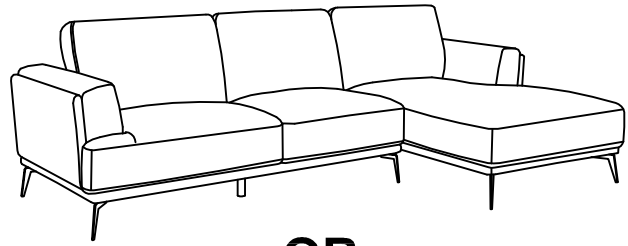

OR

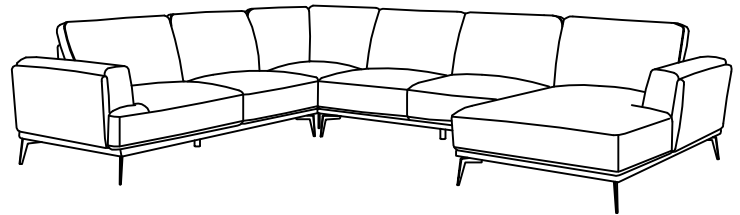

- Please keep instructions for future reference.
- Check the quantity and irregularity of parts and hardware before you start.

## PARTS

#1 1pc

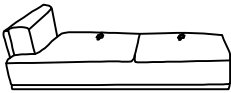

Left Loveseat

#2 1pc

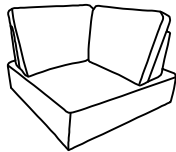

Corner

#3 1pc



Right Loveseat

#4 1pc

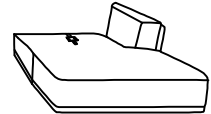

Royal Chair

#5 1pc

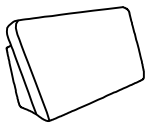

Left Back Cushion

#6 3pcs

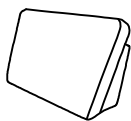

Back Cushion

#7 1pc

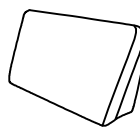

Royal Chair  
Back Cushio

# CORNER SOFA

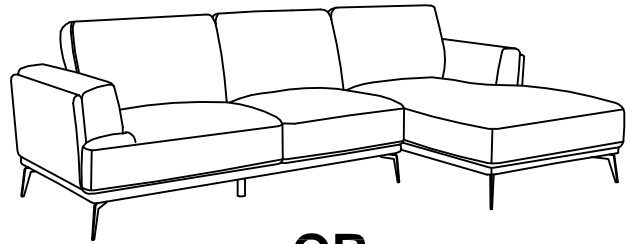

OR

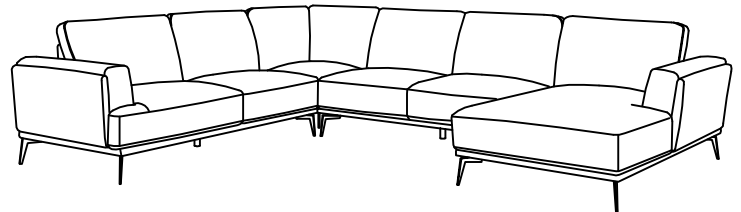

• Please keep instructions for future reference.  
 • Check the quantity and irregularity of parts and hardware before you start.

## HARDWARE

#A 16pcs

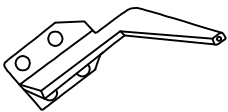

Leg

#B 3pcs

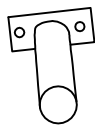

Support Leg

#C 32pcs



Screw

#D 20pcs

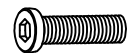

Bolt  $\text{\O}1/4\text{"} \times 1\text{-}1/2\text{"}$

#E 32pcs



Bolt  $\text{\O}5/16\text{"} \times 1\text{-}1/2\text{"}$

#F 6pcs

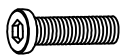

Bolt  $\text{\O}5/16\text{"} \times 1\text{"}$

#G 38pcs



Lock Washer  $\text{\O}5/16\text{"}$

#H 38pcs



Flat Washer  $\text{\O}19\text{mm}$

#I 20pcs



Lock Washer  $\text{\O}1\text{"}$

#J 52pcs



Flat Washer  $\text{\O}16\text{mm}$

#K 1pc

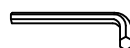

Allen Wrench M4



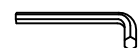





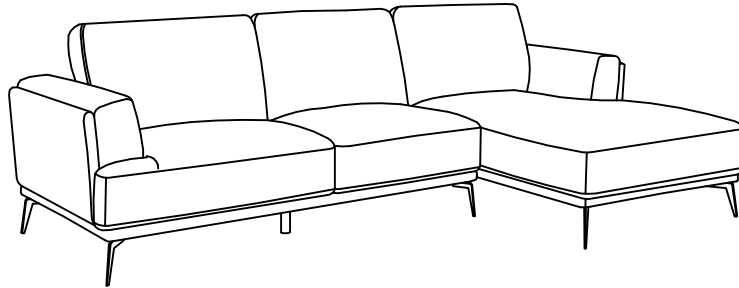

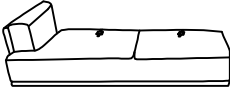











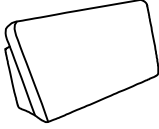
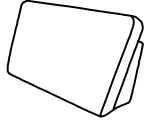
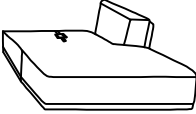

#L 1pc



Allen Wrench M5

# When you shop for this product

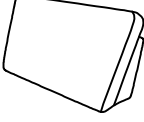

Carton	Disignation	Part		Hardware
	Left Loveseat	#1		 #A x 4pcs  #B x 1pc  #C x 8pcs  #D x 8pcs  #E x 8pcs  #F x 2pcs  #G x 10pcs  #H x 10pcs  #I x 8pcs  #J x 16pcs  #K x 1pc  #L x 1pc
	Left Back Cushion	#5		
	Back Cushion	#6		
	Royal Chair	#4		 #A x 4pcs  #B x 1pc  #C x 8pcs  #D x 4pcs  #E x 8pcs  #F x 2pcs  #G x 10pcs  #H x 10pcs  #I x 4pcs  #J x 12pcs  #K x 1pc  #L x 1pc
	Royal Chair Back Cushio	#7		

# ASSEMBLY INSTRUCTIONS

Lift Velcro and remove hardware and legs form hidden compartment.

## 1

Part #1 x1pc

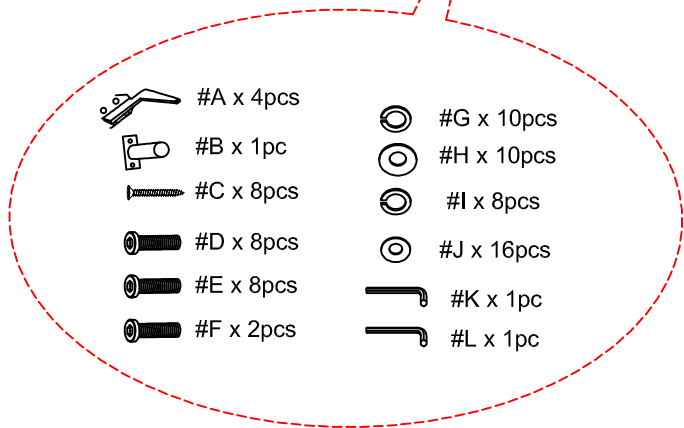
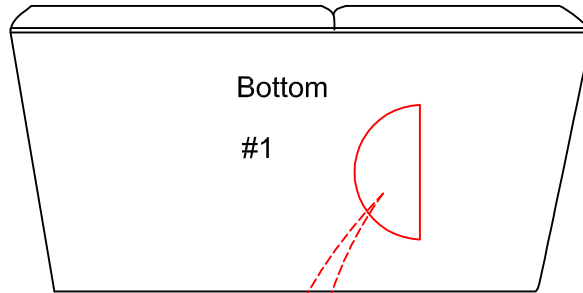

## 2

- Hardware #A x4pcs
- Hardware #B x1pc
- Hardware #C x8pcs
- Hardware #E x8pcs
- Hardware #F x2pcs
- Hardware #G x10pcs
- Hardware #H x10pcs
- Hardware #J x8pcs
- Hardware #L x1pc

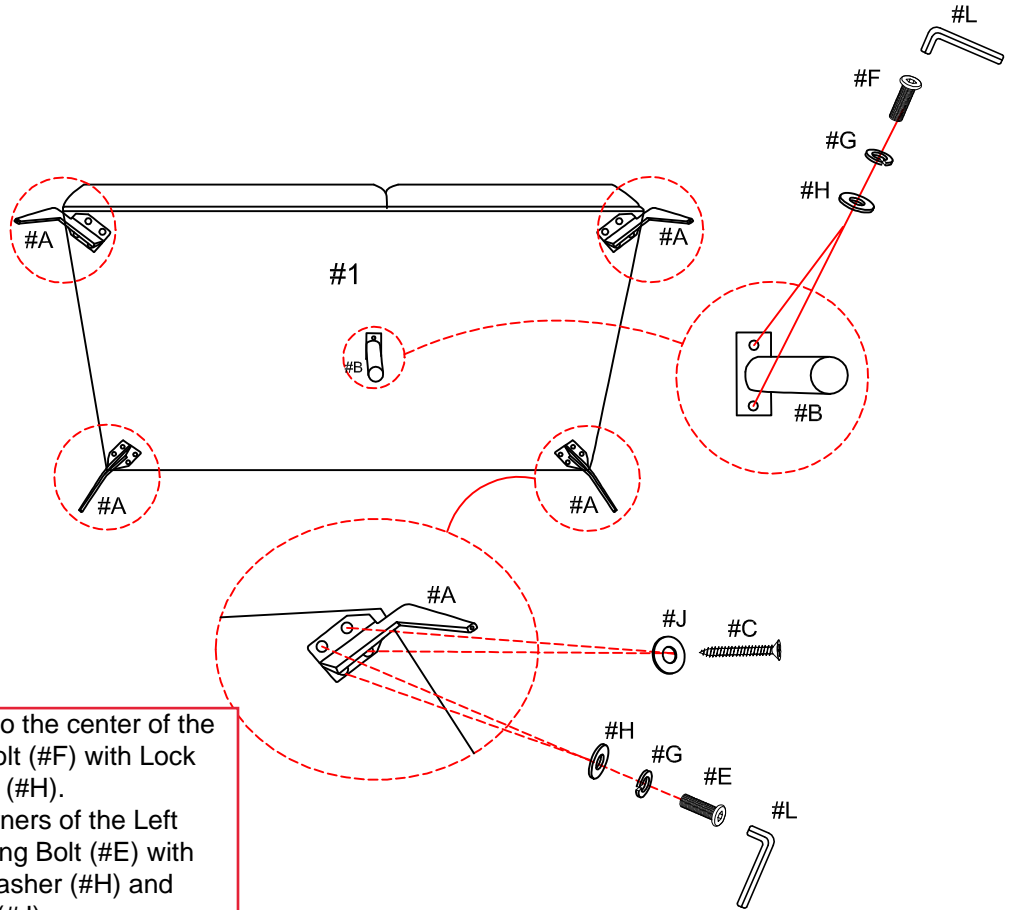

Attach the Support Leg (#B) to the center of the Left loveseat (#1) by using Bolt (#F) with Lock washer (#G) and Flat washer (#H). Align the Legs (#A) to the corners of the Left Loveseat (#1) and secure using Bolt (#E) with Lock washer (#G) and Flat washer (#H) and Screw (#C) with Flat washer (#J).

# ASSEMBLY INSTRUCTIONS

## 3

Align the back cushion (#5, #6) to the Left loveseat (#1) and secure using Bolt (#D) with Lock Washer (#I) and Flat washer (#J).

Part #5 x1pc

Part #6 x1pc

Hardware #D x8pcs

Hardware #I x8pcs

Hardware #J x8pcs

Hardware #K x1pc

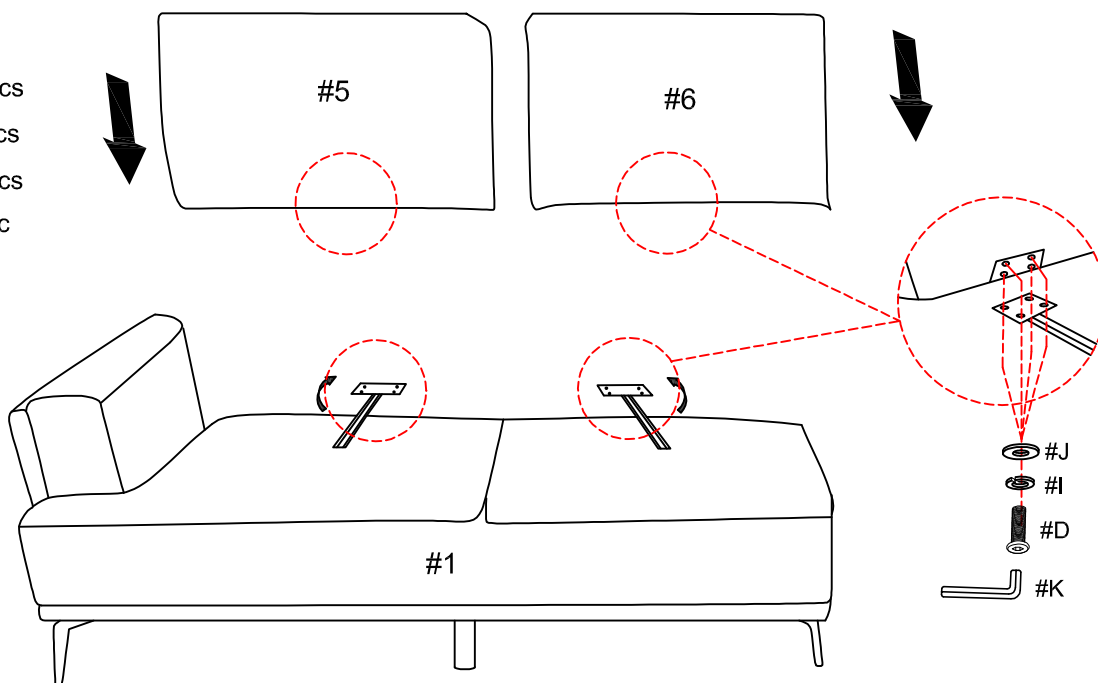

## 4

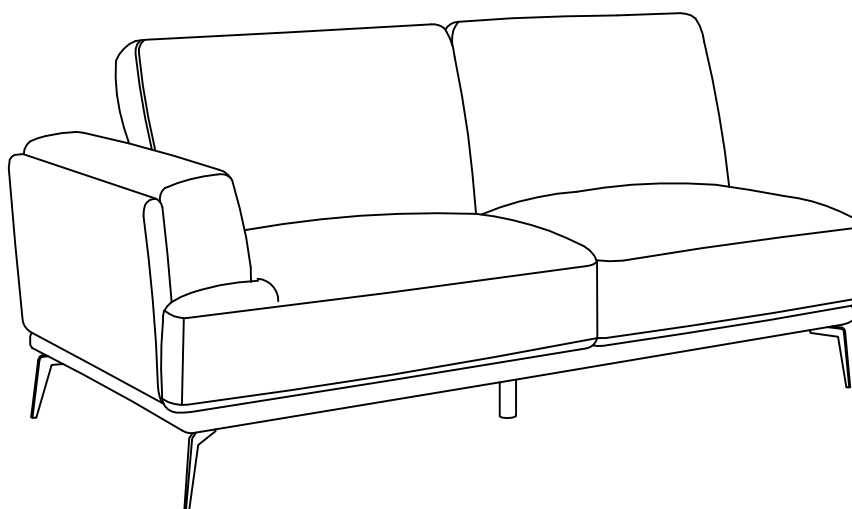













# ASSEMBLY INSTRUCTIONS

Lift velcro and remove hardware and legs from hidden compartment under the Royal chair (#4).

## 5

Part #4 x1pc

-  #A x 4pcs
-  #B x 1pc
-  #C x 8pcs
-  #D x 4pcs
-  #E x 8pcs
-  #F x 2pcs
-  #G x 10pcs
-  #H x 10pcs
-  #I x 4pcs
-  #J x 12pcs
-  #K x 1pc
-  #L x 1pc

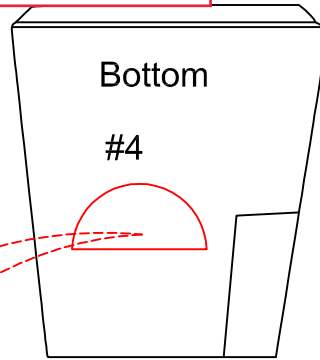

## 6

- Hardware #A x4pcs
- Hardware #B x1pc
- Hardware #C x8pcs
- Hardware #E x8pcs
- Hardware #F x2pcs
- Hardware #G x10pcs
- Hardware #H x10pcs
- Hardware #J x8pcs
- Hardware #L x1pc

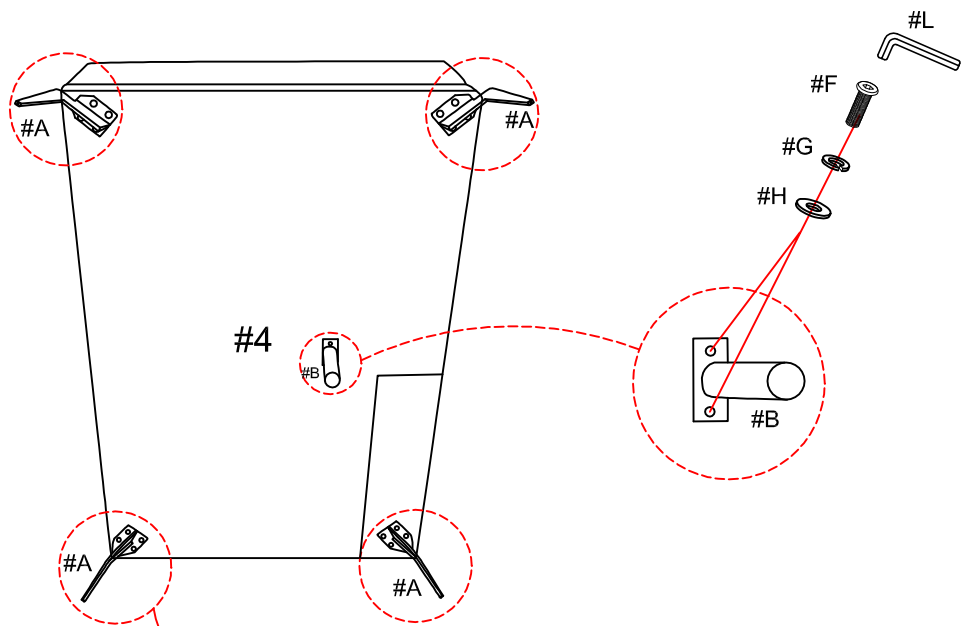

Attach the Support Leg (#B) to the center of the Royal chair (#4) by using Bolt (#F) with Lock washer (#G) and Flat washer (#H). Align the Legs (#A) to the corners of the Royal chair (#4) and secure using Bolt (#E) with Lock washer (#G) and Flat washer (#H) and Screw (#C) with Flat washer (#J).

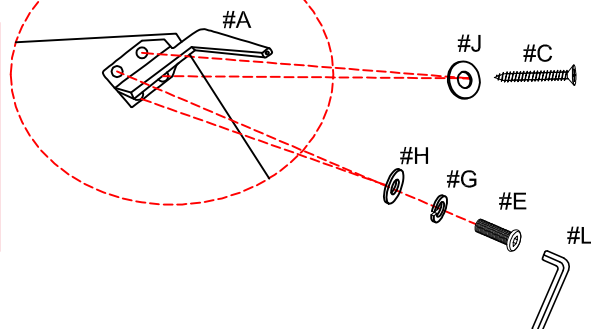

# ASSEMBLY INSTRUCTIONS

## 7

Align and secure the Royal chair back cushion (#7) to the Royal Chair (#4) by using Bolt (#D) to Lock washer (#I) with Flat washer (#J).

Part (#7) x1pc

Hardware (#D) x4pcs

Hardware (#I) x4pcs

Hardware (#J) x4pcs

Hardware (#K) x1pc

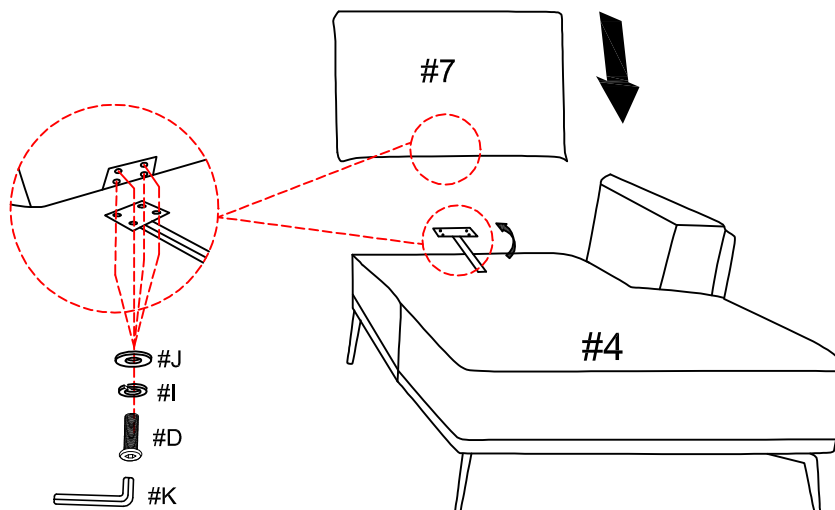

## 8

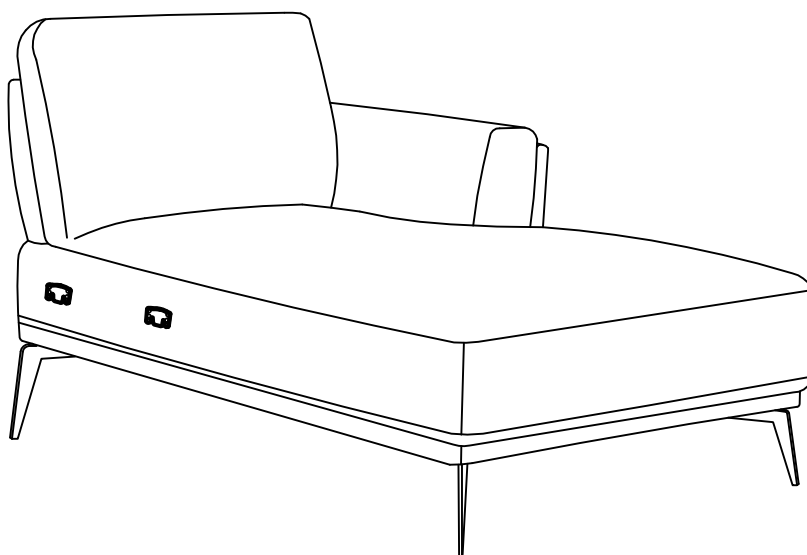

# ASSEMBLY INSTRUCTIONS

9

Lift and hook metal brackets of the Royal Chair (#4) to the metal brackets of the Left Loveseat (#1).

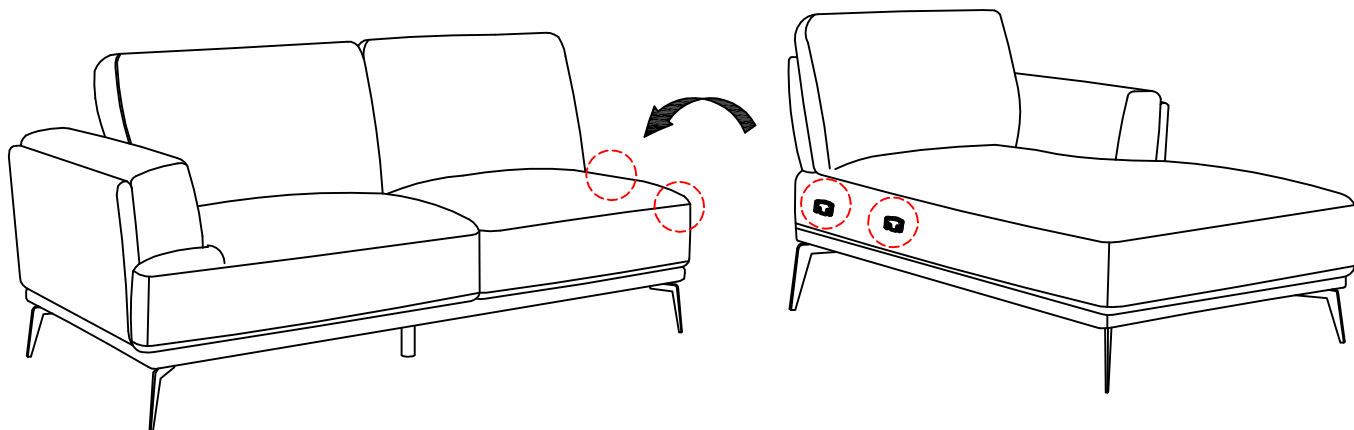
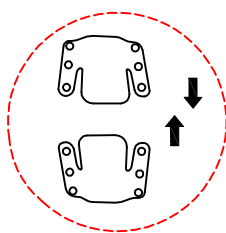



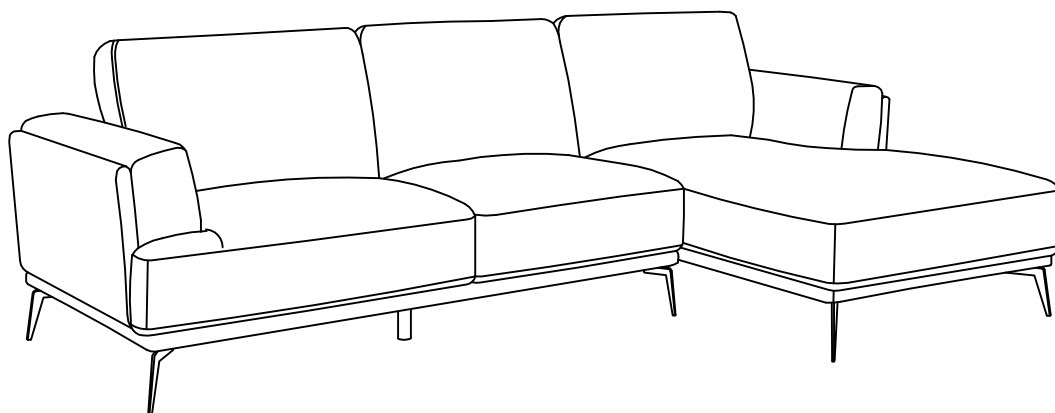



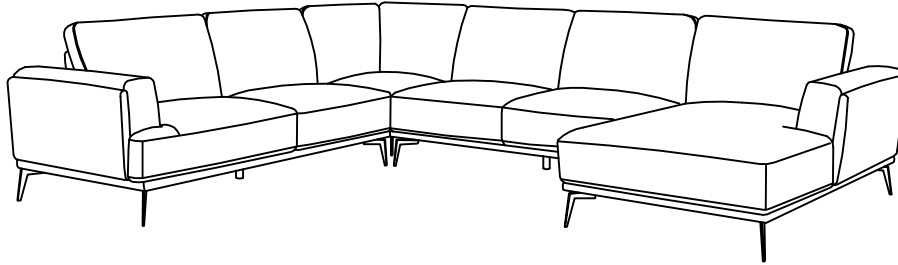













10

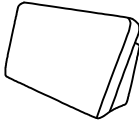
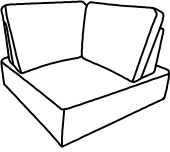

# When you shop for this product



## Two boxes of parts need to be added

Carton	Disignation	Part		Hardware
	Right Loveseat	#3		 #A x 4pcs  #B x 1pc  #C x 8pcs  #D x 8pcs  #E x 8pcs  #F x 2pcs  #G x 10pcs  #H x 10pcs  #I x 8pcs  #J x 16pcs  #K x 1pc  #L x 1pc
	Back Cushion	#6	 x 2	
	Corner	#2		 #A x 4pcs  #C x 8pcs  #E x 8pcs  #G x 8pcs  #H x 8pcs  #J x 8pcs  #L x 1pc









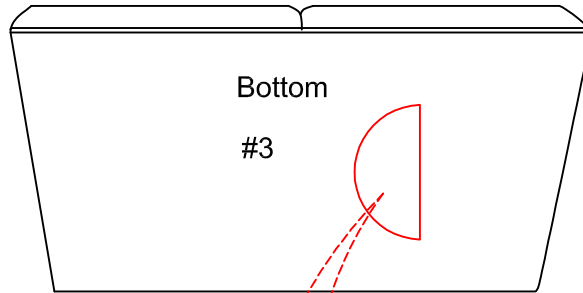



# ASSEMBLY INSTRUCTIONS

Lift the velcro and remove hardware and legs from the hidden compartment under the Right Love seat (#3).

## 11

Part #3 x1pc



-  #A x 4pcs
-  #B x 1pc
-  #C x 8pcs
-  #D x 8pcs
-  #E x 8pcs
-  #F x 2pcs
-  #G x 10pcs
-  #H x 10pcs
-  #I x 8pcs
-  #J x 16pcs
-  #K x 1pc
-  #L x 1pc

## 12

- Hardware #A x4pcs
- Hardware #B x1pc
- Hardware #C x8pcs
- Hardware #E x8pcs
- Hardware #F x2pcs
- Hardware #G x10pcs
- Hardware #H x10pcs
- Hardware #J x8pcs
- Hardware #L x1pc

Attach the Support Leg (#B) to the center of the Right Loveseat (#3) by using Bolt (#F) with Lock washer (#G) and Flat washer (#H). Align the Legs (#A) to the corners of the Right Loveseat (#3) and secure using Bolt (#E) with Lock washer (#G) and Flat washer (#H) and Screw (#C) with Flat washer (#J).

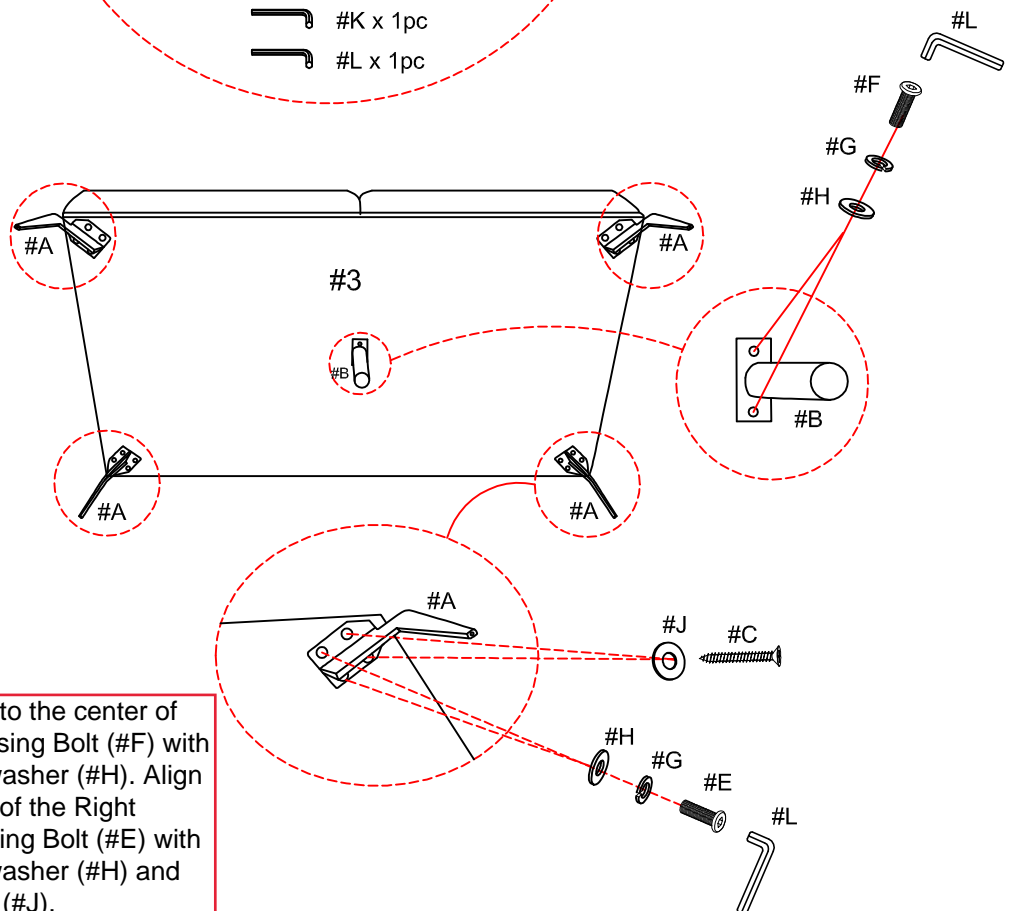

# ASSEMBLY INSTRUCTIONS

## 13

Align the back cushion (#6) to the Right Loveseat (#3) and secure using Bolt (#D) with Lock Washer (#I) and Flat washer (#J).

Part (#6) x2pcs

Hardware (#D) x8pcs

Hardware (#I) x8pcs

Hardware (#J) x8pcs

Hardware (#K) x1pc

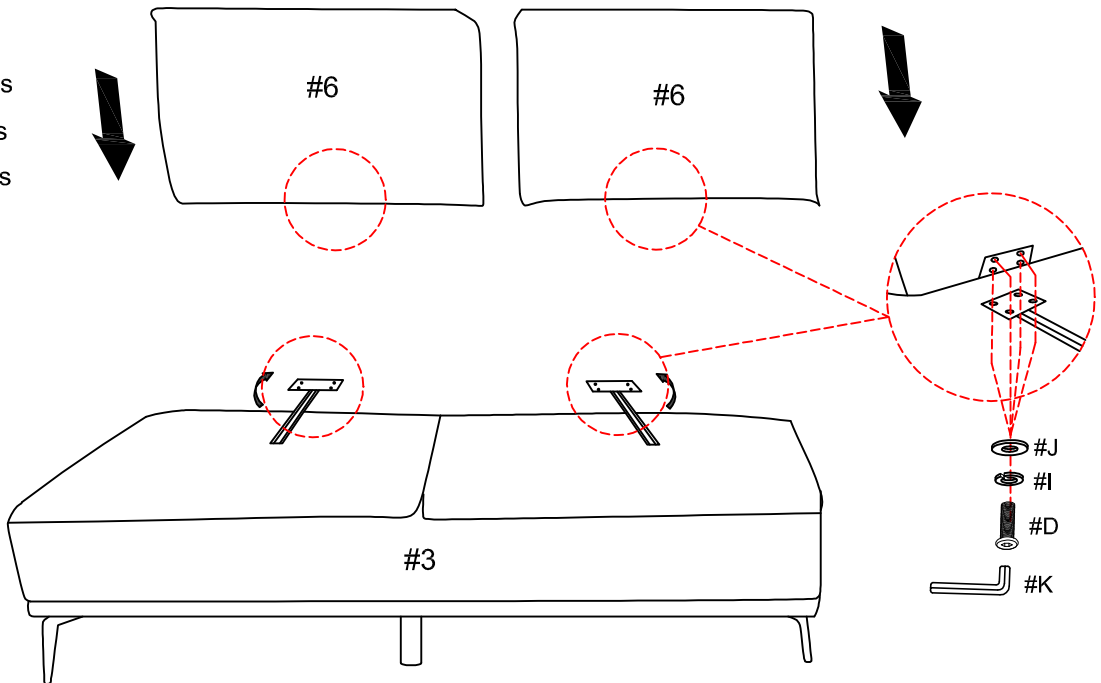

## 14

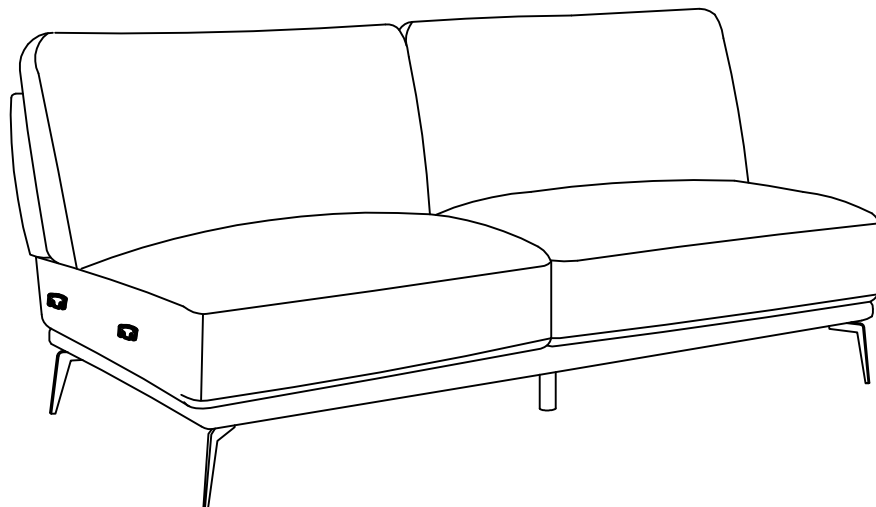

# ASSEMBLY INSTRUCTIONS

Lift the velcro and remove hardware and legs from the hidden compartment under the Corner (#2).

## 15

Part #3 x1pc

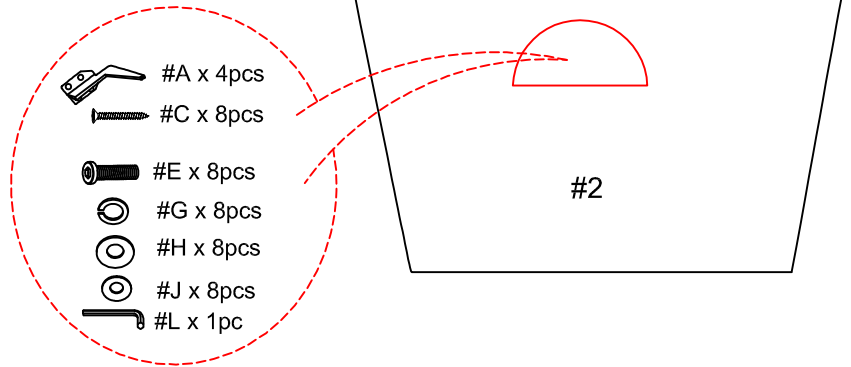

## 16

- Hardware #A x4pcs
- Hardware #C x8pcs
- Hardware #E x8pcs
- Hardware #G x8pcs
- Hardware #H x8pcs
- Hardware #J x8pcs
- Hardware #L x1pc

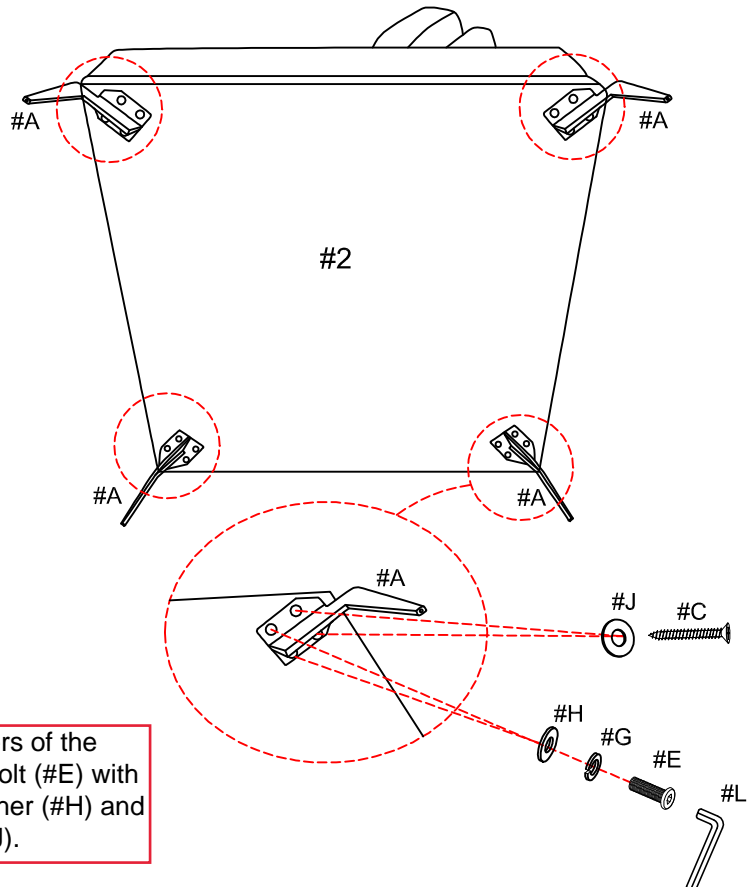

Align the Legs (#A) to the corners of the Corner (#2) and secure using Bolt (#E) with Lock washer (#G) and Flat washer (#H) and Screw (#C) with Flat washer (#J).

# ASSEMBLY INSTRUCTIONS

17

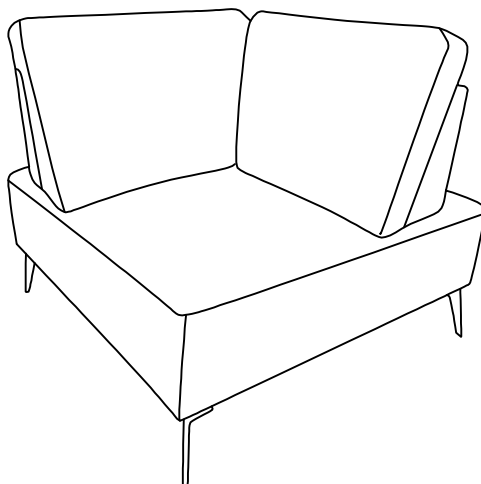

18

Lift and hook metal brackets.

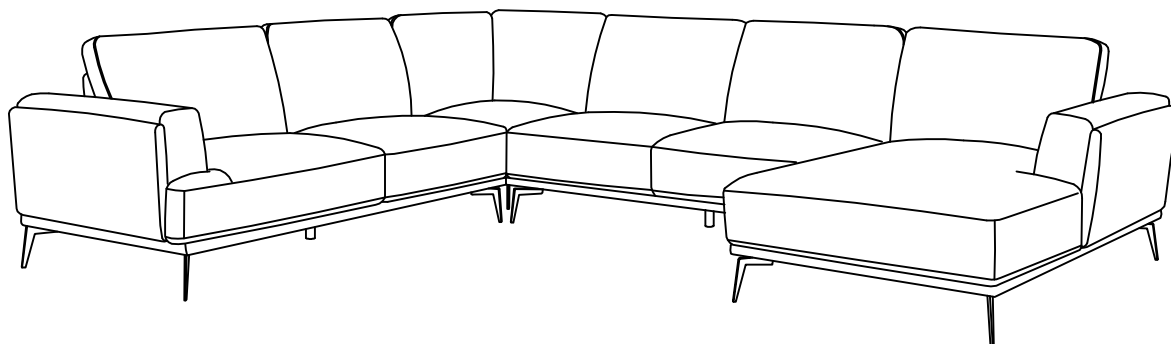
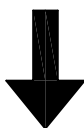
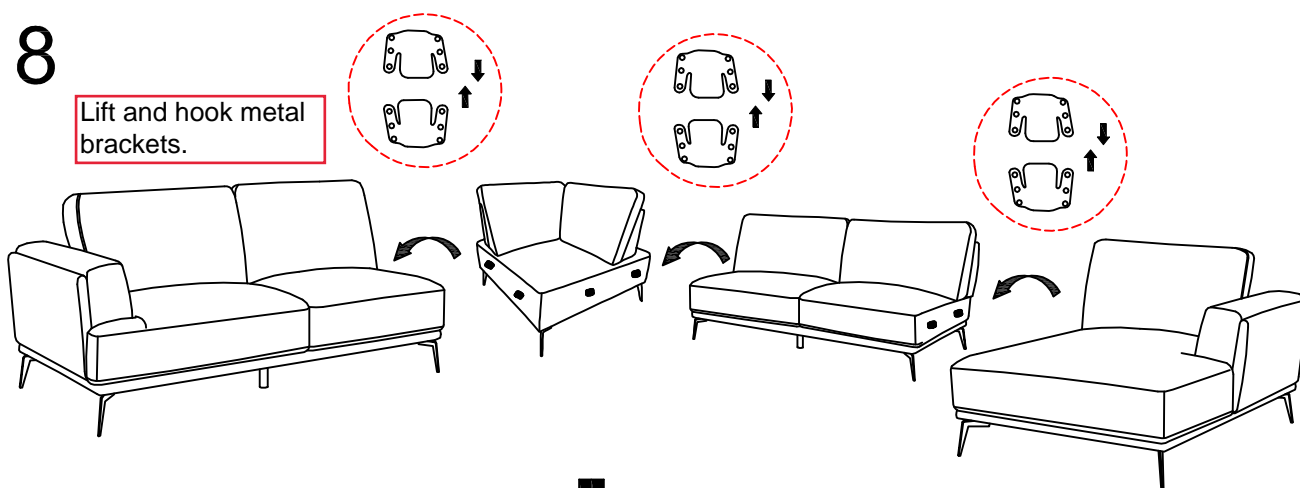

# ASSEMBLY INSTRUCTIONS

19

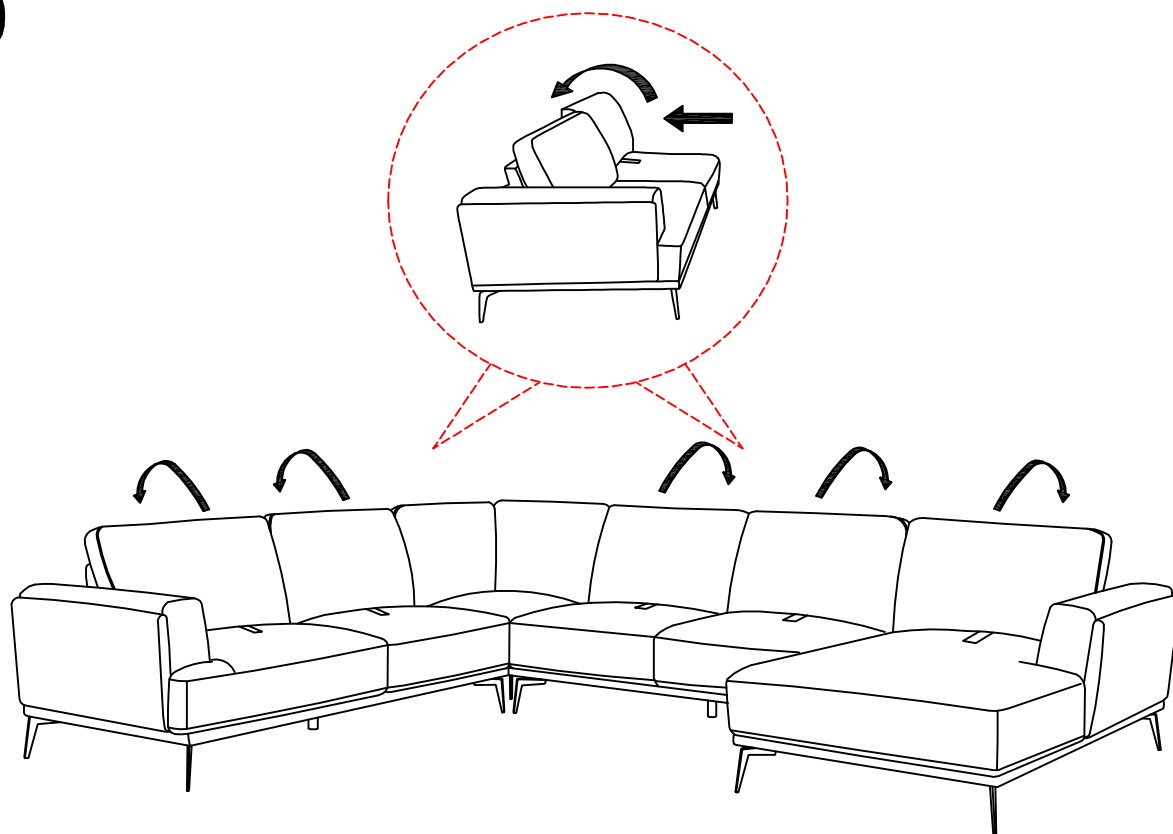

## ASSEMBLY COMPLETED



Please ensure the furniture rests on an even and flat surface. If the product wobbles or feels loose, double-check all bolts and/or screws are properly tightened and secured.



### Keep this handy!

Please retain this instruction manual and any order-related information for future reference.



### Lift, don't drag!

To avoid damage to product please always LIFT the product when transporting or adjusting the placement.